

# Design, Performance & Compliance Guide

Rediwall® Technical Information and  
Engineered Design Tables

**CSR**

# Contents

---

<b>Introduction . . . . .</b>	<b>4</b>
<b>Rediwall® Capabilities Overview. . . . .</b>	<b>5</b>
AFS System Definitions.....	6
Definition of Engineering Terms Used in this Section.....	6
References .....	6
Flexural Capacity .....	7
Lintels.....	7
Temporary Works.....	7
Reinforcement Requirements.....	8
Minimum Reinforcement .....	8
Reinforcement Detailing Constraints.....	8
<b>Rediwall® Design for Earthquake Actions . . . . .</b>	<b>9</b>
<b>Non-Ductile Wall Design . . . . .</b>	<b>9</b>
Axial Capacity .....	9
<b>Rediwall® Structural Design Tables . . . . .</b>	<b>10</b>
RW110C Structural Capacities.....	10
RW156C Structural Capacities.....	12
RW200C Structural Capacities.....	14
RW200C In-plane Shear Along Vertical PVC Webs .....	16
RW200C Curve Panel Radius .....	16
RW200C Structural Capacities (Double Reinforcement) .....	17
RW200C Double Reinforcement In-plane Shear Along Vertical PVC Webs.....	19
RW256S Structural Capacities.....	20
RW256S In-plane Shear Along Vertical PVC Webs.....	22
RW275S Structural Capacities.....	23
RW275S In-plane Shear Along Vertical PVC Webs.....	25
RW300S Structural Capacities.....	26
RW300S In-plane Shear Along Vertical PVC Webs.....	28
<b>Non-Ductile Wall Detailing . . . . .</b>	<b>29</b>
Junctions.....	29
Standard Wall Junctions .....	29
Non-Ductile Blade Walls/Columns.....	32
Movement Joints .....	33
<b>Limited Ductile Wall Design . . . . .</b>	<b>34</b>
Limited Ductile Design .....	34
Limited Ductile Design Examples .....	35
<b>Limited Ductile Wall Detailing . . . . .</b>	<b>37</b>
Boundary Elements.....	37
Limited Ductile Wall – Horizontal Reinforcement Laps .....	39
Blade Columns .....	40
Junctions.....	40
Movement Joints .....	41
Construction Joint.....	41
Wall Junctions Joints .....	42

# Contents (continued)

<b>AFS Rediwall® Blade Columns. . . . .</b>	<b>43</b>
Introduction .....	43
Rediwall® RW200C FF Column Panel .....	43
Compliance and Verification .....	44
AFS Rediwall® Advanced Blade Column Design .....	45
Design Examples .....	46
AFS Rediwall® Advanced Column Design Tables .....	47
RW200C Blade Column Structural Capacity .....	48
RW256S Blade Column Structural Capacity .....	49
RW275S Blade Column Structural Capacity .....	50
RW300S Blade Column Structural Capacity .....	51
Fire Performance .....	52
<b>Core Filling of Walls. . . . .</b>	<b>53</b>
Introduction .....	53
Concrete Mix Design.....	53
<b>Self Compacting Concrete. . . . .</b>	<b>54</b>
AFS Approved SCC Mix.....	54
Pre-Construction .....	54
Concrete placement .....	55
Concrete Clean-up .....	55
<b>Performance . . . . .</b>	<b>56</b>
Fire Testing .....	57
Fire Resistance Levels (FRL)s.....	57
Non-Combustibility – Wall Applications & Finishes.....	59
Non-Combustibility – Specific Wall Applications .....	65
Acoustic Performance.....	69
Thermal Insulation.....	72
Weatherproofing .....	74
Termite Resistance.....	74
Bushfire Resistance .....	74
<b>Appendices . . . . .</b>	<b>75</b>
AFS Rediwall® Standard Bracing & Lifting Bar.....	75
Certifications.....	75
AFS Rediwall Standard Bracing .....	76
AFS Rediwall® Standard Lifting Bar.....	77
Rediwall® CodeMark Certificate of Conformity .....	78
AFS Rediwall® Fire Resistance Level (FRL) Reports.....	79
Stephen Grubits & Associates – Rediwall® CodeMark Evaluation .....	85
Rediwall® AS5113 Facade Test Report .....	86
Rediwall® AS5637.1 Classification Report.....	87
Rediwall® AS1530.3 Fire Hazard Properties Test Report .....	88
Rediwall® Acoustic Performance Assessment Reports .....	89
Rediwall® AS/NZS 4859 Thermal Performance Assessments .....	95
Rediwall® Weatherproofing Assessment Report.....	96

# Introduction

---

Volume 1– 'AFS Rediwall® Design, Performance and Compliance Guide' forms part of a comprehensive afs rediwall® Systems Manual that encompasses Volume 1 , 2 and 3. This manual covers the aspects of Design, Performance, Compliance, Construction and Installation for all rediwall® products current at the time of publication.

Volume 1 should be read in conjunction with Volume 2 and 3. Downloads of these individual Volumes are available via the Resource Centre at [www.afsformwork.com.au](http://www.afsformwork.com.au)

**Disclaimer:** The products referred to in this document have been manufactured by or on behalf of CSR Building Products Limited ('CSR') to comply with the Building Code of Australia and any relevant Australian Standards. While any design or usage guidelines set out in this document have been prepared in good faith by CSR, they are of a general nature only and are intended to be used in conjunction with project specific design and engineering advice.

It is the responsibility of the customer to ensure that CSR's products are suitable for their chosen application, including in respect of project-specific matters such as, but not limited to structural adequacy, acoustic, fire resistance/combustibility, thermal, and weatherproofing requirements. All information relating to design/ installation/application of these products is offered without warranty and no responsibility can be accepted by CSR for errors and omissions, or for any use of the relevant products not in accordance with CSR's technical literature or any other relevant industry standards. For current technical and warranty documentation relating to CSR's products, visit the AFS website at [www.afsformwork.com.au](http://www.afsformwork.com.au)



# Rediwall® Capabilities Overview

## Rediwall® System Capabilities

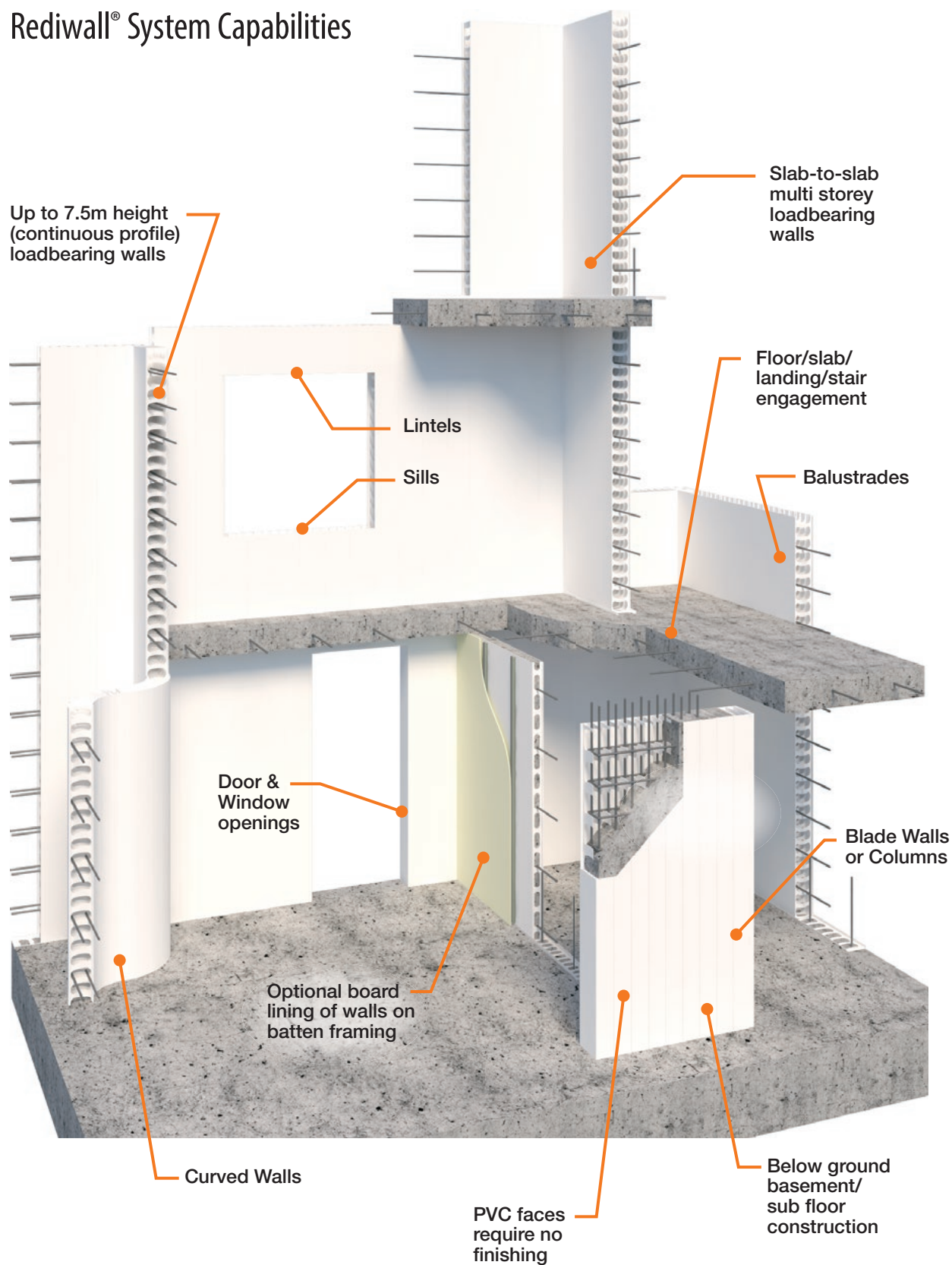

Note: If rediwall® is exposed to UV, appropriate protective finish shall be applied.

## AFS System Definitions

AFS Blade Column	A short Blade Wall designed and detailed with U-bars in lieu of ties to WSU Advanced Design Methods in accordance with AS3600-2018.
AFS Column	A column designed and detailed with ties to AS3600-2018 Section 10 Columns.
AFS Limited Ductile Walls	Walls designed in accordance with AS3600-2018 Section 2.2 Strength and clauses 14.4 General Earthquake Requirements and 14.6 Limited Ductile Walls.
AFS Non-Ductile Walls	Walls designed in accordance with AS3600-2018 Section 2.2 Strength and clauses 14.4 General Earthquake Requirements.

## Definition of Engineering Terms Used in this Section

$t_w$	Effective structural concrete wall width
$t_{w,fire}$	Effective wall width for fire
$S_{web}$	Web spacing
$S_{punch}$	Vertical punch spacing
$A_c$	Percentage of web opening
Align	Allowance for on-site mis-alignment of web openings
$N_{layers}$	Number of Reinforcement layers
$d_h$	Distance to centre of horizontal bar from the rediwall® concrete face
$f'_{c,max}$	Maximum concrete strength
$f_y$	Steel yield stress
Bar Max	Max reinforcement bar size
$e$	The eccentricity of the load measured at right angle to the plane of the wall
$H_{wu}$	Unsupported wall height
$H_{we}$	Effective wall height
$t_{total}$	total wall width
$D_{punch}$	Horizontal width of punch
$A_{st}$	Area of reinforcement
$I_{xx}$	Stud moment of inertia
$\mu$	Structural ductility factor [AS3600-2018]
$S_p$	Structural performance factor [AS3600-2018]

## References

1. 'AFS Logicwall® and AFS Rediwall® axial-flexural interaction curve generation numerical and theoretical investigation', Centre for Infrastructure Engineering, Western Sydney University
2. 'AS3600-2018 Concrete Structures Code'
3. 'Fire-Resistance of Rediwall® – Determination in accordance with AS3600', SGA Report 2013/277.26 R1.1 issued 9/9/2019

## Lintels

Lintel tables have been prepared based on a wall with minimum reinforcement for bending and shear capacity. If additional capacity is required, extra reinforcement can be designed and detailed by the engineer.

## Temporary Works

Temporary works are to be detailed by the project designers to suit the project design and conditions. AFS standard bracing details may be used subject to the limitations given on the drawing and certifications. Refer to Appendix – AFS Standard Bracing Drawings.

AFS standard bracing is to be installed in accordance with the standard bracing drawings and Volume 3 – 'Rediwall® Installation Guide – Rediwall Temporary Construction Bracing'. For further information on AFS standard bracing, please contact AFS Technical Services

## Reinforcement Requirements

The individual cells within afs rediwall® allow horizontal shrinkage and thermal movements in the concrete with the PVC webs acting as crack inducers. This allows afs rediwall® to provide crack control without additional reinforcement.

For fire rated reinforced walls to AS3600-2018 Cl11.7.1 use minimum vertical reinforcement ratio ( $\rho_w$ ) of 0.0015 or the value required by structural analysis.

Due to the presence of the PVC webs in afs rediwall® steel congestion should be avoided to facilitate adequate compaction of concrete. As a guide steel ratios in excess of 0.02 in a single layer should not be used unless the amount and disposition of the reinforcement will not prevent the proper placement and compaction of the concrete at splices and at junctions of members.

## Minimum Reinforcement

For walls that have tensile forces from any load combination AS3600-2018 11.7 Minimum reinforcement shall apply.

Examples of such walls are:

- Walls resisting lateral loads
- Walls acting as deep beams
- Walls with load combinations of bending and compression producing tension stress.
- Where reinforced afs rediwall® walls do not require a high degree of crack control for tensile forces we recommend a minimum reinforcement spacing of 400mm.

Notes: AS3600 does not recognise the use of plain

concrete in wall elements, though some International standards offer guidance in this area. Use of afs rediwall® walls unreinforced will require reference to other codes such as ACI 318 and BS8110.1 where it can be shown that no tensile forces result from any load combination of bending and compression.

**TABLE A1: Minimum Reinforcement for Reinforced Walls ( $p = A_{st}/A_{conc}$ )**

Location	Vertical (p)	Horizontal (p)
Internal (A1, A2)	0.0025 (0.0015 Cl.11.7.1(a))	0.0015
External (B1, B2)	0.0025 (0.0015 Cl.11.7.1(a))	0.0025
Limited Ductile	0.0025	0.0025
Deep Beam	AS3600 Sect 12	AS3600 Sect 12

Steel ratios in excess of 0.02 should not be used unless the amount and disposition of the reinforcement will not prevent the proper placement of the concrete in walls and at splices and junction members.

## Reinforcement Detailing Constraints

For heavily loaded walls where reinforcement ratio is high, it is critical that reinforcement is detailed carefully to avoid congestion within the wall which creates difficulties when core filling and may result in voids or insufficient concrete compaction.

When detailing reinforcement to be placed in Rediwall® the following spacing constraints must be noted:

- For single reinforcement carrier walls the reinforcement is centrally placed at minimum horizontal centres as shown.
- For double reinforcement carrier walls, RW200C

and RW256S, RW275S & RW300S the reinforcement is located toward each face of the wall with concrete cover as shown.

- Typical total reinforcement rates are less than 0.01. Rates in excess of 0.02 are not recommended as it creates possible congestion issues.
- Areas with higher reinforcement concentrations such as laps and corners should be reviewed.



# Rediwall® Design for Earthquake Actions

Rediwall® is to be designed to cater for earthquake actions as per AS1170.4 Earthquake Actions and AS3600-2018 Section 14 Design for Earthquake Actions. The design and detailing of the wall will depend on the Structural System selected by the designer for

the building from Table 14.3 Structural Ductility Factor and Structural Performance Factor. This will normally be either Non-Ductile Structural Walls or Limited Ductile Structural Walls.

## Non-Ductile Wall Design

The use of the Simplified Design Method in Section 11.5 is limited to Non-Ductile Walls by Cl 14.4.4.1 and Cl 11.5.2 Limitations on the use of the Method. Non-Ductile Rediwall® are to be designed to Section 2.2 and 14.4.

### 14.4.4.1 General

*'Walls shall be designed in accordance with Section 10 or Section 11 as appropriate except that the simplified design method for walls subjected to vertical compression forces provided in Clause 11.5 of this standard shall only be used for non-ductile walls.'*

## Axial Capacity

AFS Rediwall® can be designed in accordance with Section 11 of AS3600 – 2018.

$$\phi N_u = \phi (t_w - 1.2e - 2e_a) 0.6 f_c \quad [\text{AS3600 Cl.11.5.3}]$$

Where:

$\phi = 0.65$  strength reduction factor

$N_u =$  ultimate strength per unit wall length

$t_w =$  thickness of the wall

$e =$  eccentricity of the load measured at right angles to the plane of the wall

$e_a = \frac{H_{we}^2}{2500t_w}$  an additional eccentricity

$H_{we} = kH_{wu}$  effective height of a braced wall

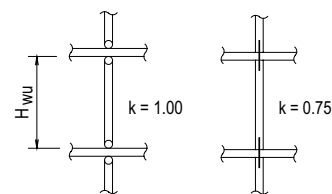

[AS3600 Cl.11.5.3]

### 11.5.2 Limitation on use of method

*'Structural walls designed using Clause 11.5.3 Shall –*

- be limited to a maximum design axial stress of 3 MPa unless vertical and horizontal reinforcement is provided on both wall faces and divided equally between the two wall faces;*
- not constructed on sites with soil classifications of De or Ee, as defined in AS 1170.4, and where subjected to earthquake design actions; and*
- have a ratio of effective height to thickness that does not exceed 20 for singly reinforced wall or 30 for doubly reinforced walls.*

*Otherwise, the wall shall be designed as a column in accordance with Section 10.'*

# Rediwall® Structural Design Tables

## RW110C Structural Capacities

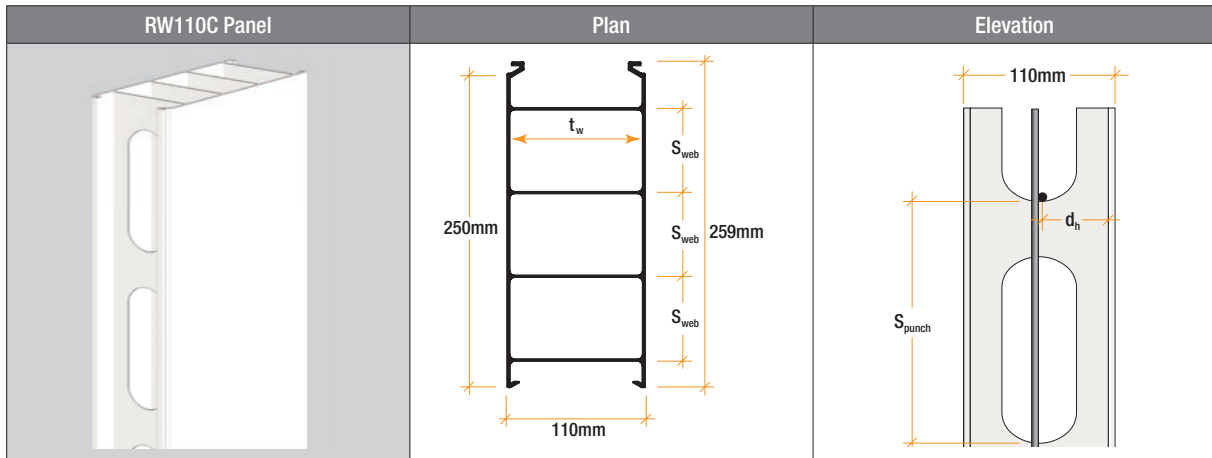

### RW110C Axial Capacity $\phi N_u$ (kN/m)

$t_w$	$t_{fire}$	$S_{web}$	$S_{punch}$	$A_c$	$N_{layers}$	$d_h$	$f'_{c,max}$
105	105	66.6	175	36.9%	1	52.5	40

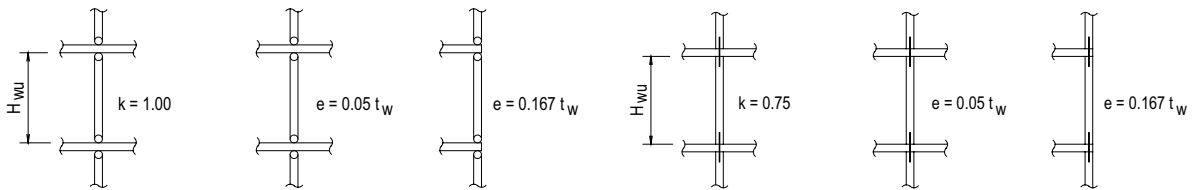

$k = 0.75$		Continuous Floor $e = 0.05 t_w$			Discontinuous Floor $e = 1/6 t_w$		
$H_{wu}$	$H_{we}$	25 MPa	32 MPa	40 MPa	25 MPa	32 MPa	40 MPa
3000	2250	315*	315*	315*	315*	315*	315*
Bearing capacity at standard bottom plate		861	1102	1377	861	1102	1377

\*AS3600-2018 11.5.2(a) 3 MPa max. for centrally reinforced wall.

### RW110C Minimum Reinforcement

RW110C		Vertical Bars (min. N12-350)			
Allowable Bars		N12	N16	N20	N24
Horizontal (min. N12-350)	N12				
	N16				
	N20				
	N24				

Horizontal Bar Spacing 175/350  
Vertical Bar Spacing 150 to 350

Acceptable
With Caution
Not Recommended

### RW110C Out of Plane Flexural Capacity ( $\phi M_u$ kNm/m) ( $N^*=0$ )

Vert. Bars	d	$\rho$	25 MPa	32 MPa	40 MPa	50 MPa
N12@400	41	0.007	–	–	–	–
N12@300	41	0.0093	5.42	–	–	–
N12@250	41	0.0112	6.34	6.56	–	–
N16@400	39	0.0131	6.53	6.79	6.98	7.13
N16@350	39	0.0149	7.26	7.61	7.85	8.05
N16@300	39	0.0174	8.16	8.63	8.97	9.24
N16@250	39	0.0209	9.28	9.96	10.44	10.83
N16@200	39	0.0261	10.63	11.69	12.45	13.05
		$\rho_{st,min}$ [8.1.6.1.(2)]	0.0089	0.0101	0.0113	0.0126

$\phi M_u = \phi(f_y \rho b d^2 (1 - 0.6 \rho f_y / f'_c))$

### RW110C Standard Lintels with Vertical PVC Webs

UDL capacity of a simple standard lintel with minimum reinforcement other than extra top and bottom bars shown. Designer can utilise the slab over as T-beam, extra horizontal or vertical shear reinforcement if extra strength is required.

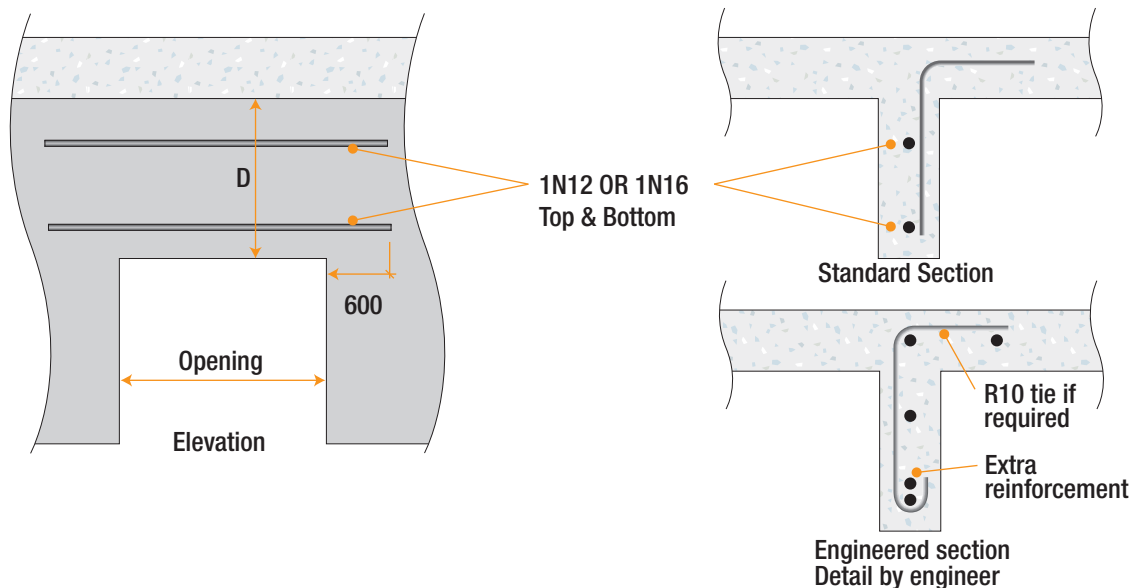

### RW110C Standard Lintels with Vertical PVC Webs $w^*$ (kN/m) UDL

D	1N12 Top & Bottom, Depth (mm)				1N16 Top & Bottom, Depth (mm)			
	150	300	450	750	150	300	450	750
$d_{eff}$	50	200	350	650	50	200	350	650
Span (mm)								
3600	4.7	9.8	14.9	25.1	5.6	10.8	16.2	28.8
3300	5.5	11.6	17.7	29.8	5.1	12.1	18.2	33.6
3000	6.7	13.6	20.8	36.1	6.8	13.6	20.8	40.3
2700	7.7	15.5	24.3		7.7	15.5	24.3	
2400	8.8	18.1	29.2		8.8	18.1	29.2	
2100	10.2	21.7	36.5		10.2	21.7	36.5	
1800	12.3	27.1			12.3	27.1		
1500	15.3	36.2			15.3	36.2		
1200	20.4				20.4			
900	30.7				30.7			
	$f'_c = 25\text{MPa}, 50 \text{ cover (min)}$				$f'_c = 25\text{MPa}, 50 \text{ cover (min)}$			

  =  $\phi V_{uc}$  governs, otherwise  $\phi M_u$   
  = Design to AS3600–2018 Sect 12

## RW156C Structural Capacities

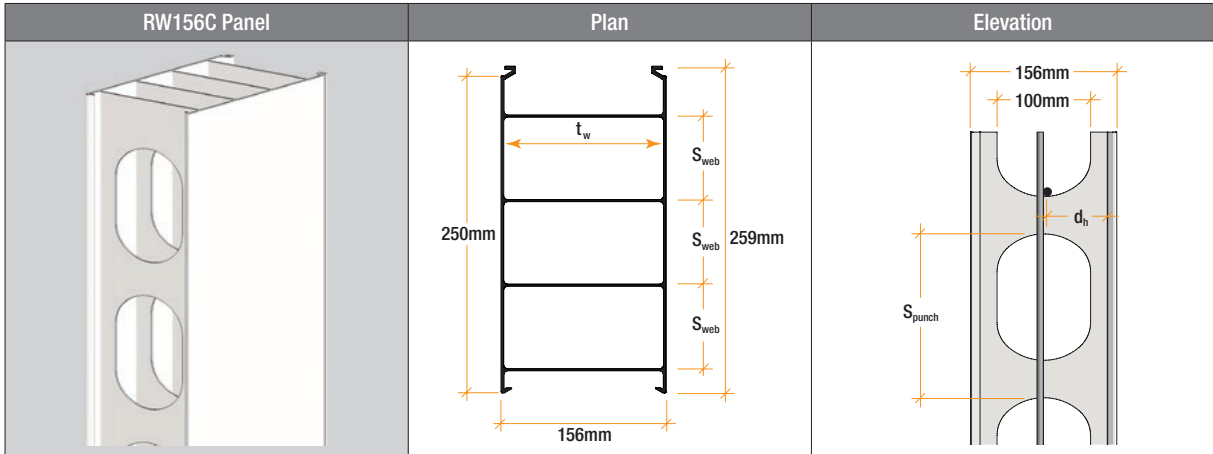

### RW156C Axial Capacity $\phi N_u$ (kN/m)

$t_w$	$t_{fire}$	$S_{web}$	$S_{punch}$	$A_c$	$N_{layers}$	$d_h$	$f'_{c,max}$
151	151	66.6	175	44.3%	1	75.5	50

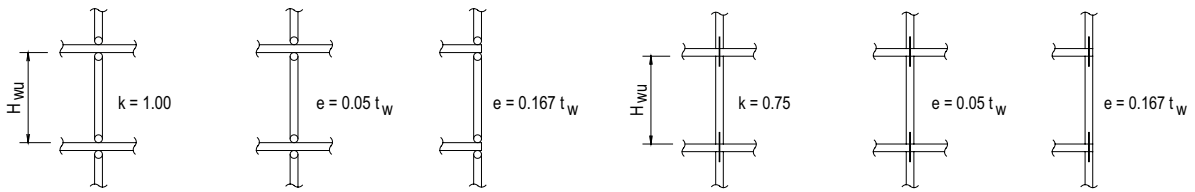

k = 0.75		Continuous Floor $e = 0.05t_w$				Discontinuous Floor $e = 1/6t_w$			
$H_{wu}$	$H_{we}$	25 MPa	32 MPa	40 MPa	50 MPa	25 MPa	32 MPa	40 MPa	50 MPa
3900	2925	450*	450*	450*	450*	450*	450*	450*	450*
Bearing capacity at standard bottom plate		1357	1737	2171	2713	1357	1737	2171	2713

\*AS3600-2018 11.5.2(a) 3 MPa max. for centrally reinforced wall.

### RW156C Minimum Reinforcement

RW156C		Vertical Bars (min. N12-300)			
Allowable Bars		N12	N16	N20	N24
Horizontal (min. N12-350)	N12	Acceptable	Acceptable	Acceptable	Not Recommended
	N16	Acceptable	With Caution	Not Recommended	Not Recommended
	N20	Not Recommended	Not Recommended	Not Recommended	Not Recommended
	N24	Not Recommended	Not Recommended	Not Recommended	Not Recommended

Horizontal Bar Spacing 175/350  
Vertical Bar Spacing 150 to 350

Acceptable
With Caution
Not Recommended

### RW156C Out of Plane Flexural Capacity $\phi M_u$ (kNm/m) ( $N^*=0$ )

Vert. Bars	d	$\rho$	25 MPa	32 MPa	40 MPa	50 MPa
N16@400	62	0.0082	11.15	–	–	–
N16@350	62	0.0093	12.54	12.89	–	–
N16@300	62	0.0109	14.33	14.8	15.14	–
N16@250	62	0.0131	16.68	17.35	17.84	18.23
N16@200	62	0.0163	19.87	20.94	21.69	22.3
N20@300	60	0.0176	19.65	20.8	21.62	22.28
N20@250	60	0.0211	22.32	23.98	25.16	26.11
N20@200	60	0.0264	25.53	28.12	29.97	31.45
		$\rho_{st,min}$ [8.1.6.1.(2)]	0.0077	0.0087	0.0098	0.0109
$\phi M_u = \phi(f_y \rho b d^2 (1 - 0.6 \rho f_y / f'_c))$						

### RW156C Standard Lintels with Vertical PVC Webs

UDL capacity of a simple standard lintel with minimum reinforcement other than extra top and bottom bars shown. Designer can utilise the slab over as T-beam, extra horizontal or vertical shear reinforcement if extra strength is required.

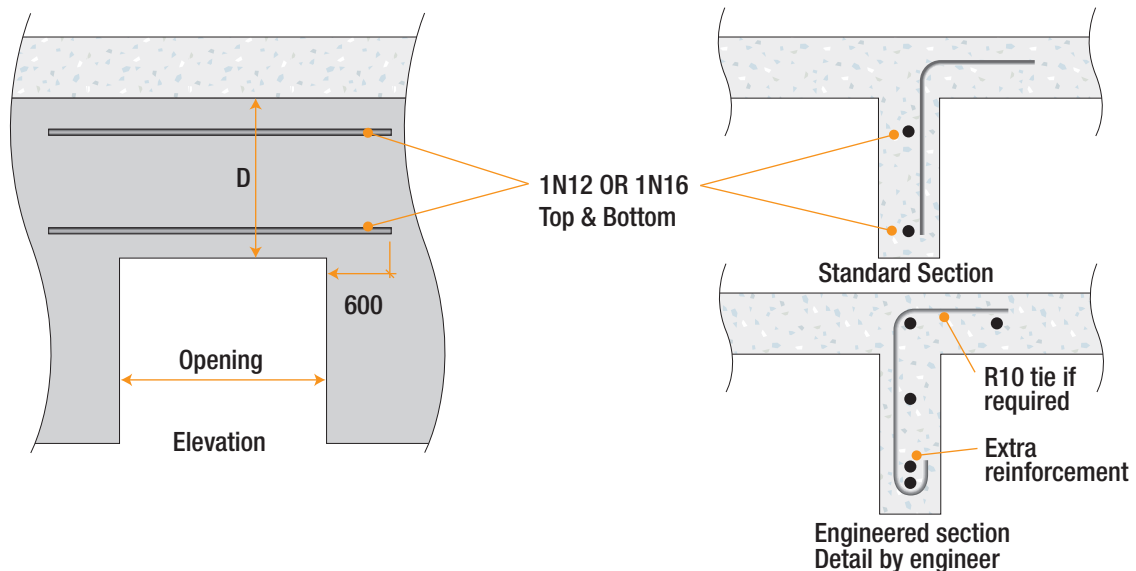

### RW156C Standard Lintels with Vertical PVC Webs $w^*$ (kN/m) UDL

D	1N12 Top & Bottom, Depth (mm)				1N16 Top & Bottom, Depth (mm)			
	150	300	450	750	150	300	450	750
$d_{eff}$	50	200	350	650	50	200	350	650
Span (mm)								
3600	4.8	9.9	15.0	25.2	8.1	17.1	26.1	44.2
3300	5.7	11.8	17.8	30.0	9.6	20.3	31.1	52.6
3000	6.9	14.2	21.6	36.3	11.6	23.3	35.7	63.6
2700	8.5	17.6	26.7		13.1	26.6	41.7	
2400	10.8	22.3	33.7		15.0	31.0	50.0	
2100	14.1	29.1	44.1		17.5	37.2	62.6	
1800	19.2	39.6			21.0	46.5		
1500	26.3	57.0			26.3	62.0		
1200	35.1				35.1			
900	52.6				52.6			
	$f'_c = 25\text{MPa}, 50 \text{ cover (min)}$				$f'_c = 25\text{MPa}, 50 \text{ cover (min)}$			
	= $\phi V_{uc}$ governs, otherwise $\phi M_u$ = Design to AS3600–2018 Sect 12							

## RW200C Structural Capacities

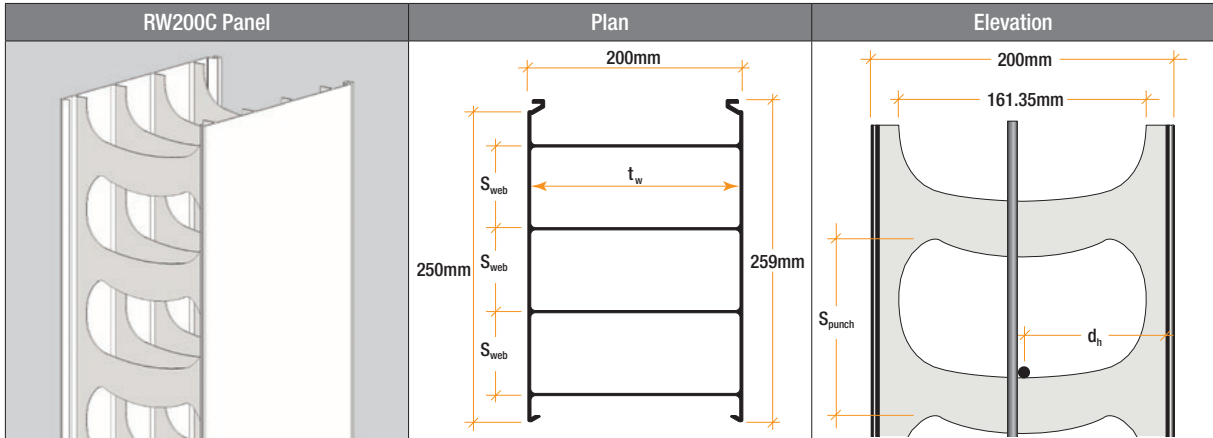

### RW200C Axial Capacity $\phi N_u$ (kN/m)

$t_w$	$t_{fire}$	$S_{web}$	$S_{punch}$	$A_c$	$N_{layers}$	$d_h$	$f'_{c,max}$
195	195	66.6	116.7	50.1%	1	97.5	65

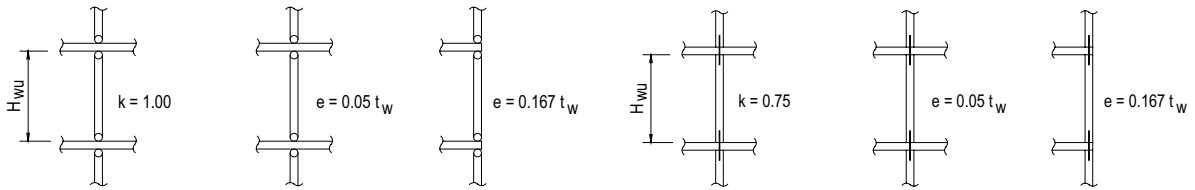

$k = 0.75$	$H_{WU}$	$H_{we}$	Continuous Floor $e = 0.05 t_w$					Discontinuous Floor $e = 1/6 t_w$					
			25 MPa	32 MPa	40 MPa	50 MPa	65 MPa <sup>#</sup>	25 MPa	32 MPa	40 MPa	50 MPa	65 MPa <sup>#</sup>	
	5000	3750	585*	585*	585*	585*	585*	585*	585*	585*	585*	585*	585*
Bearing capacity at standard bottom plate			1863	2385	2982	3727	4845	1863	2385	2982	3727	4845	4845

<sup>#</sup> for  $f'_c > 50$  MPa, CSR appointed installer only.  
 \*AS3600-2018 11.5.2(a) 3 MPa max. for centrally reinforced wall.

### RW200C Minimum Reinforcement

RW200C		Vertical Bars (min. N12-350)			
Allowable Bars		N12	N16	N20	N24
Horizontal (min. N12-350)	N12	Acceptable	Acceptable	Acceptable	With Caution
	N16	Acceptable	Acceptable	Acceptable	With Caution
	N20	With Caution	With Caution	Not Recommended	Not Recommended
	N24	Not Recommended	Not Recommended	Not Recommended	Not Recommended

Horizontal Bar Spacing 233/350	
Vertical Bar Spacing 150 to 350	
Acceptable	Acceptable
With Caution	With Caution
Not Recommended	Not Recommended

## RW200C Out of Plane Flexural Capacity ( $\phi M_u$ kNm/m) ( $N^*=0$ )

Vertical Bars	d	$\rho$	25 MPa	32 MPa	40 MPa	50 MPa	65 MPa
N16@350	84	0.0069	17.6	–	–	–	–
N16@300	84	0.008	20.22	20.69	–	–	–
N16@250	84	0.0096	23.75	24.43	24.91	–	–
N16@200	84	0.012	28.72	29.78	30.54	31.14	31.7
N20@300	82	0.0128	28.86	30.01	30.83	31.49	32.1
N20@250	82	0.0154	33.37	35.03	36.21	37.16	38.03
N20@200	82	0.0193	39.35	41.94	43.79	45.27	46.63
		$\rho_{st,min}$ [8.1.6.1.(2)]	0.0069	0.0078	0.0087	0.0097	0.0111

$\phi M_u = \phi(f_y \rho b d^2 (1 - 0.6 \rho f_y / f'_c))$

## RW200C Standard Lintels with Vertical PVC Webs

UDL capacity of a simple standard lintel with minimum reinforcement other than extra top and bottom bars shown. Designer can utilise the slab over as T-beam, extra horizontal or vertical shear reinforcement if extra strength is required.

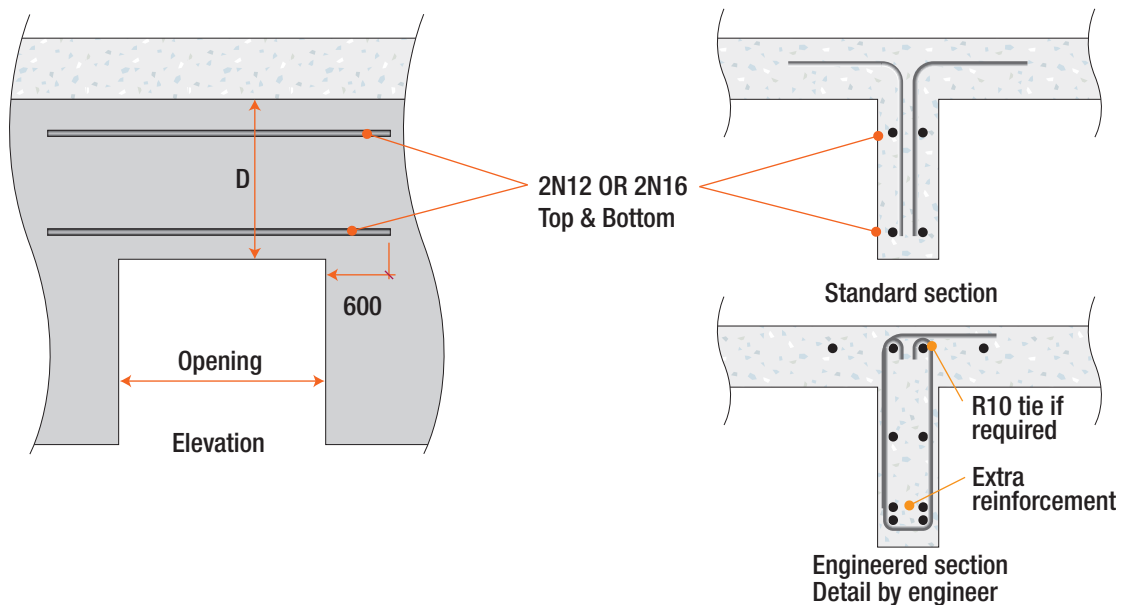

## RW200C Standard Lintels with Vertical PVC Webs $w^*$ (kN/m)

D	2N12 Top & Bottom, Depth (mm)				2N16 Top & Bottom, Depth (mm)			
	150	300	450	750	150	300	450	750
$d_{eff}$	50	200	350	650	50	200	350	650
Span (mm)								
3600	4.9	10.0	15.1	25.3	8.3	17.3	26.3	44.4
3300	5.8	11.9	17.9	30.1	9.9	20.6	31.3	52.8
3000	7.0	14.3	21.7	36.4	11.9	24.9	37.9	63.9
2700	8.6	17.7	26.8		14.7	30.8	46.8	
2400	10.9	22.4	33.9		18.6	39.0	59.3	
2100	14.3	29.3	44.3		24.4	50.9	77.4	
1800	19.5	39.9			30.9	68.4		
1500	28.0	57.4			38.7	91.2		
1200	43.8				51.5			
900	77.3				77.3			
	$f'_c = 25\text{MPa}, 50\text{ cover (min)}$				$f'_c = 25\text{MPa}, 50\text{ cover (min)}$			
	<p>Yellow cell = <math>\phi V_{UC}</math> governs, otherwise <math>\phi M_u</math></p> <p>Grey cell = Design to AS3600–2018 Sect 12</p>							

## RW200C In-plane Shear Along Vertical PVC Webs

### RW200C PVC Profile/Spacing

$t_w$	$S_{punch}$	$N_{layers}$	$A_c$	Align	Bar Max	Min Reo	Max Spacing	$t_{w, shear}$	$\mu$	$k_{co}$
195	117	1	50.1%	80%	20	0.0025	350	78.2	0.36	0.20

### RW200C In Plane Shear along Vertical PVC Web $\emptyset V_u$ (kN/m)

Horizontal Bars	$\rho$	25 MPa	32 MPa	40 MPa	50 MPa	65 MPa
N12@233	0.0025	110.5	117	123.5	130.9	140.6
N16@350	0.0029	121.8	128.2	134.8	142.2	151.9
N16@233	0.0044	158.2	164.6	171.2	178.6	188.3
N20@350	0.0046	162.5	169	175.6	182.9	192.7
N20@233	0.0069	219.4	225.9	232.5	239.8	249.6
N16@117	0.0088	266.2	272.6	279.2	286.6	296.3
Max. Shear		273.6	350.2	437.7	547.2	547.2

$$\emptyset V_u = \emptyset (\mu \rho t_w f_y + k_{co} t_w f'_{ct})$$

$$\emptyset V_{max} = \emptyset 0.2 f'_c t_w shear < \emptyset 10 t_w shear$$

## RW200C Curve Panel Radius

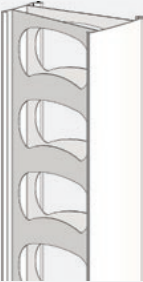
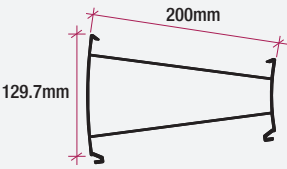
15° Curved Wall Panel	Description
 	<p>An extruded PVC panel used to form curved walls. Each panel produces a 15° curve. Adjoining panels, either the 115mm spacer or additional curved panels are added to create walls of the required radius between 0.7m to 4.8m.</p>

### Example of Achievable Radius with 15° Panel & Spacer/Panel Combinations

Panel Arrangement	Outer Radius
15° panel	500 ± 25mm
2 x 15° panel + 1 x 115 Spacer	700 ± 25mm
1 x 15° panel + 1 x 115 Spacer	950 ± 25mm
1 x 15° panel + 1 x RW200C Panel	1450 ± 50mm
1 x 15° panel + 1 x RW200C Panel + 115 Spacer	1900 ± 50mm
1 x 15° panel + 2 x RW200C Panel	2450 ± 50mm



## RW200C Structural Capacities (Double Reinforcement)

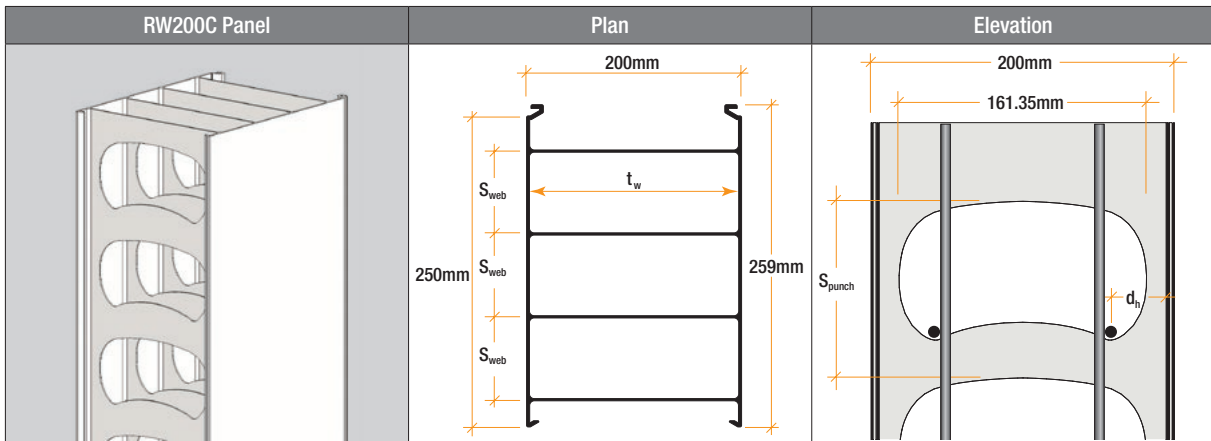

### RW200C Double Reinforcement Axial Capacity $\phi N_u$ (kN/m)

$t_w$	$t_{fire}$	$S_{web}$	$S_{punch}$	$A_c$	$N_{layers}$	$d_h$	$f'_{c,max}$
195	195	66.6	116.7	50.1%	2	38.5	65

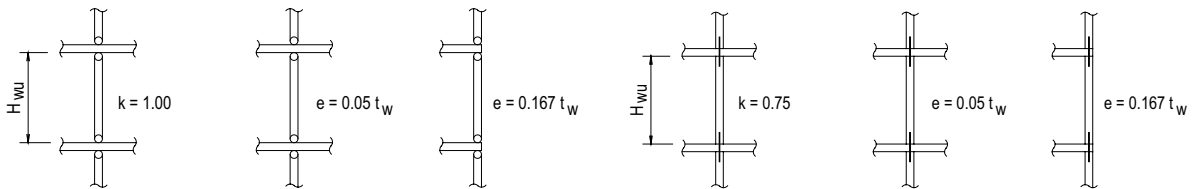

$k = 0.75$	$H_{wu}$	$H_{we}$	Continuous Floor $e = 0.05 t_w$					Discontinuous Floor $e = 1/6 t_w$				
			25 MPa	32 MPa	40 MPa	50 MPa	65 MPa*#	25 MPa	32 MPa	40 MPa	50 MPa	65 MPa*#
	6000	4500	902	1155	1443	1804	2345	656	840	1050	1313	1706
	5000	3750	1130	1447	1809	2261	2939	885	1133	1416	1770	2300
	4500	3375	1229	1573	1967	2458	3196	983	1259	1573	1967	2557
	4200	3150	1283	1643	2053	2567	3337	1038	1328	1660	2075	2698
	3900	2925	1334	1707	2134	2668	3468	1088	1393	1741	2176	2829
	3600	2700	1381	1767	2209	2761	3589	1135	1453	1816	2270	2951
	3300	2475	1424	1822	2278	2847	3701	1178	1508	1885	2356	3062
	3000	2250	1463	1872	2340	2926	3803	1217	1558	1947	2434	3164
	2700	2025	1498	1918	2397	2997	3896	1253	1603	2004	2505	3257
	2400	1800	1530	1958	2448	3060	3978	1284	1644	2055	2569	3339
	2100	1575	1558	1994	2493	3116	4051	1312	1680	2100	2625	3412
	1800	1350	1582	2025	2532	3165	4114	1337	1711	2139	2673	3475
Bearing capacity at standard bottom plate			1863	2385	2982	3727	4845	1863	2385	2982	3727	4845

\* for  $f'_c > 50$  MPa, CSR appointed installer only.

# for non-ductile walls only.

### RW200C Double Reinforcement Minimum Reinforcement

RW200C##		Vertical Bars - Each Face (min. N12-350)			
Allowable Bars		N12	N16	N20	N24 <sup>1</sup>
Horizontal (min. N12-350)	N12	Acceptable	Acceptable	Acceptable	With Caution
	N16	Acceptable	Acceptable	With Caution	Not Recommended
	N20	With Caution	With Caution	With Caution	Not Recommended
	N24	Not Recommended	Not Recommended	Not Recommended	Not Recommended

## Double layer if specified by project engineer.

Horizontal Bar Spacing 233/350

Vertical Bar Spacing 150 to 350

1N24 One side only, N16 max other side.

Acceptable
With Caution
Not Recommended

RW200C Double Reinforcement Out of Plane Flexural Capacity ( $\phi M_u$  kNm/m) ( $N^*=0$ )

Vertical Bars*	d	$\rho^*$	25 MPa	32 MPa	40 MPa	50 MPa	65 MPa#
N12@300	145	0.0026	21.09	–	–	–	–
N12@250	145	0.0031	25.14	25.36	25.51	–	–
N16@400	143	0.0035	27.43	27.7	27.88	28.04	–
N16@350	143	0.004	31.15	31.5	31.74	31.94	32.13
N16@300	143	0.0047	36.04	36.51	36.84	37.11	37.36
N16@250	143	0.0056	42.73	43.4	43.89	44.28	44.63
N16@200	143	0.0071	52.44	53.5	54.25	54.86	55.42
N20@300	141	0.0074	53.56	54.71	55.54	56.19	56.8
N20@250	141	0.0089	63.02	64.67	65.85	66.8	67.67
N20@200	141	0.0112	76.4	78.99	80.84	82.32	83.68
	$\rho_{st,min}$ [8.1.6.1.(2)]		0.0023	0.0026	0.0029	0.0033	0.0037

$\phi M_u = \phi(f_y \rho b d^2 (1 - 0.6 \rho f_y / f'_c))$

\*Tension bars one face.

# for non-ductile walls only.

RW200C Double Reinforcement Lintels with Vertical PVC Webs

UDL capacity of a simple standard double reinforcement lintel with minimum reinforcement other than extra top and bottom bars shown. Designer can utilise the slab over as T-beam, extra horizontal or vertical shear reinforcement if extra strength is required.

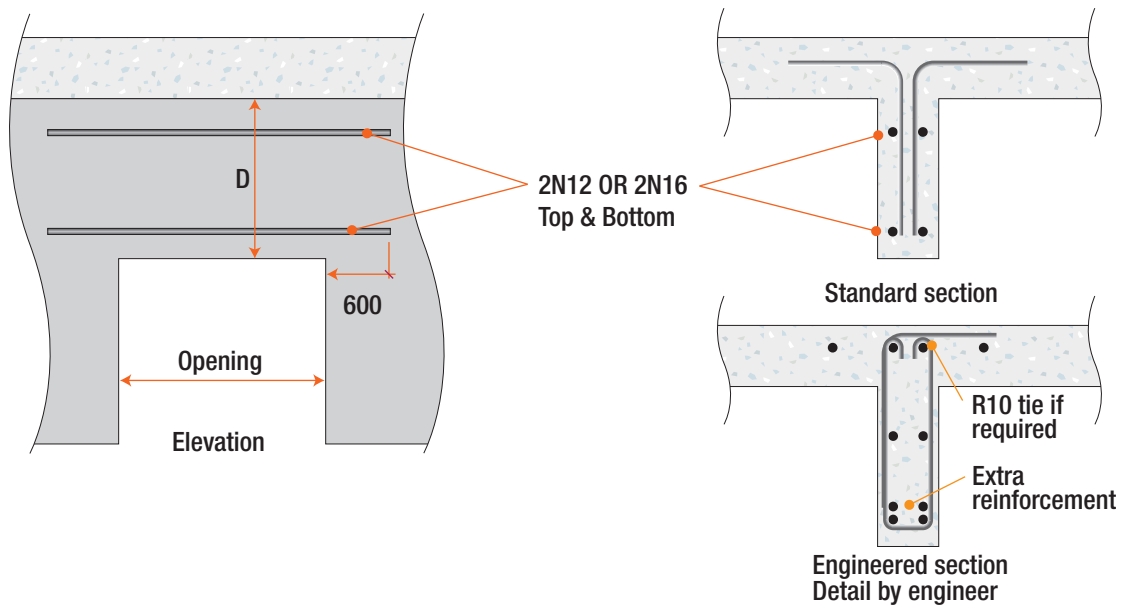

RW200C Double Reinforcement Lintels with Vertical PVC Webs  $w^*$ (kN/m)

D	2N12 Top & Bottom, Depth (mm)				2N16 Top & Bottom, Depth (mm)			
	150	300	450	750	150	300	450	750
$d_{eff}$	50	200	350	650	50	200	350	650
Span (mm)								
3600	9.3	19.5	29.7	50.1	14.1	27.4	40.9	72.6
3300	11.0	23.2	35.3	59.6	15.5	30.4	46.0	84.7
3000	13.3	28.0	42.7	72.1	17.2	34.2	52.6	101.6
2700	16.5	34.6	52.7		19.3	39.1	61.3	
2400	20.8	43.8	66.7		22.1	45.6	73.6	
2100	25.8	54.7	87.2		25.8	54.7	92.0	
1800	30.9	68.4			30.9	68.4		
1500	38.7	91.2			38.7	91.2		
1200	51.5				51.5			
900	77.3				77.3			
$f'_c = 25\text{MPa}, 50\text{ cover (min)}$				$f'_c = 25\text{MPa}, 50\text{ cover (min)}$				
<div style="display: flex; justify-content: space-between;"> <div style="width: 45%;"> <p><span style="background-color: yellow; border: 1px solid black; display: inline-block; width: 15px; height: 10px; margin-right: 5px;"></span> = <math>\phi V_{uc}</math> governs, otherwise <math>\phi M_u</math></p> <p><span style="background-color: gray; border: 1px solid black; display: inline-block; width: 15px; height: 10px; margin-right: 5px;"></span> = Design to AS3600–2018 Sect 12</p> </div> <div style="width: 45%;"></div> </div>								

## RW200C Double Reinforcement In-plane Shear Along Vertical PVC Webs

## RW200C Double Reinforcement PVC Profile/Spacing

$t_w$	$S_{punch}$	$N_{layers}$	$A_c$	Align	Bar Max	Min Reo	Max Spacing	$t_{w, shear}$	$\mu$	$k_{co}$
195	117	2	50.1%	100%	16	0.0025	350	97.7	0.36	0.20

RW200C Double Reinforcement In Plane Shear along Vertical PVC Web  $\phi V_u$  (kN/m)

Horizontal Bars	$\rho$	25 MPa	32 MPa	40 MPa	50 MPa	65 MPa#
2N12@350	0.0033	175.1	183.8	192.6	202.4	215.5
2N12@233	0.0050	230.0	238.6	247.4	257.3	270.5
2N16@350	0.0059	260.2	268.8	277.6	287.5	300.5
2N16@233	0.0088	357.7	366.3	375.1	385.0	398.1
2N16@117	0.0176	366.4	468.9	586.2	674.2	687.3
Max. Shear		366.4	468.9	586.2	732.7	732.7
$\phi V_u = \phi(\mu \rho t_w f_y + k_{co} t_w f'_{ct})$						
$\phi V_{max} = \phi 0.2 f'_c t_w shear < \phi 10 t_w shear$						
# for non-ductile walls only.						

## RW256S Structural Capacities

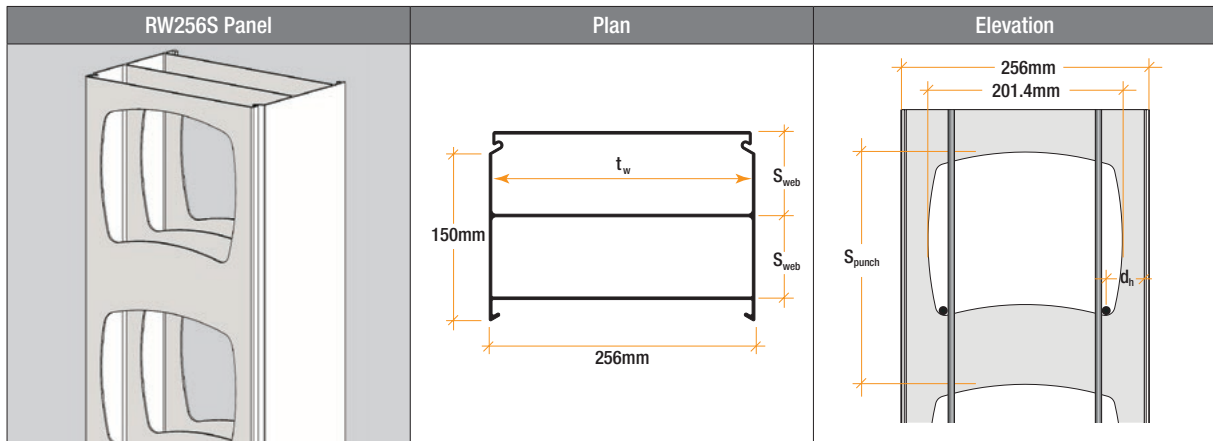

### RW256S Axial Capacity $\phi N_u$ (kN/m)

$t_w$	$t_{fire}$	$S_{web}$	$S_{punch}$	$A_c$	$N_{layers}$	$d_h$	$f'_{c,max}$
251	251	73.5	240	51.3%	2	42.7	65

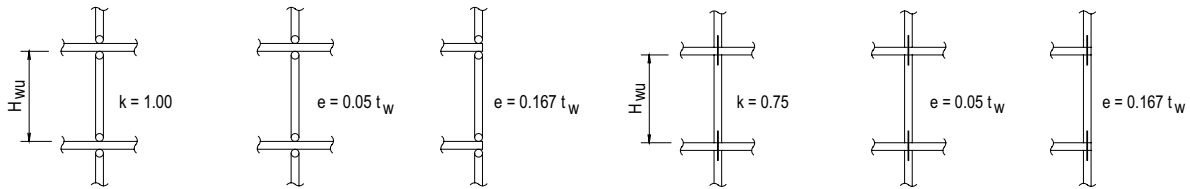

$k = 0.75$	$H_{wu}$	$H_{we}$	Continuous Floor $e = 0.05 t_w$					Discontinuous Floor $e = 1/6 t_w$				
			25 MPa	32 MPa	40 MPa	50 MPa	65 MPa*#	25 MPa	32 MPa	40 MPa	50 MPa	65 MPa*#
	6000	4500	1543	1975	2468	3085	4011	1226	1570	1962	2453	3188
	5000	3750	1720	2202	2752	3440	4472	1404	1797	2246	2808	3650
	4500	3375	1797	2300	2875	3593	4671	1480	1895	2369	2961	3849
	4200	3150	1839	2354	2942	3678	4781	1523	1949	2436	3045	3959
	3900	2925	1878	2404	3005	3756	4883	1562	1999	2499	3124	4061
	3600	2700	1914	2450	3063	3829	4977	1598	2046	2557	3196	4155
	3300	2475	1948	2493	3116	3895	5064	1631	2088	2610	3263	4242
	3000	2250	1978	2532	3165	3956	5143	1662	2127	2659	3324	4321
	2700	2025	2006	2567	3209	4012	5215	1690	2163	2703	3379	4393
	2400	1800	2031	2599	3249	4061	5279	1714	2194	2743	3429	4457
	2100	1575	2052	2627	3284	4105	5336	1736	2222	2778	3472	4514
	1800	1350	2071	2651	3314	4142	5385	1755	2246	2808	3510	4563
Bearing capacity at standard bottom plate			2362	3024	3780	4725	6142	2362	3024	3780	4725	6142

\* for  $f'_c > 50$  MPa, CSR appointed installer only.

# for non-ductile walls only.

### RW256S Minimum Reinforcement

RW256S		Vertical Bars - Each Face (min. N12-350)				
Allowable Bars		N12	N16	N20	N24	N28
Horizontal (min. N12-350)	N12	Acceptable	Acceptable	Acceptable	Acceptable	Acceptable
	N16	Acceptable	Acceptable	Acceptable	With Caution	With Caution
	N20	With Caution	With Caution	With Caution	Not Recommended	Not Recommended
	N24	Not Recommended	Not Recommended	Not Recommended	Not Recommended	Not Recommended

Horizontal Bar Spacing 240  
Vertical Bar Spacing 150 to 350

Acceptable
With Caution
Not Recommended

## RW256S Out of Plane Flexural Capacity $\phi M_u$ (kNm/m) ( $N^*=0$ )

Vertical Bars*	d	$\rho^*$	25 MPa	32 MPa	40 MPa	50 MPa	65 MPa#
N12@250	194	0.0023	34.13	–	–	–	–
N16@400	192	0.0026	37.42	37.69	–	–	–
N16@350	192	0.003	42.57	42.91	43.16	–	–
N16@300	192	0.0035	49.35	49.83	50.16	50.43	50.68
N16@250	192	0.0042	58.71	59.39	59.87	60.26	60.62
N16@200	192	0.0052	72.42	73.48	74.23	74.84	75.4
N20@300	190	0.0055	74.37	75.52	76.34	77	77.61
N20@250	190	0.0066	87.98	89.64	90.82	91.77	92.64
N20@200	190	0.0083	107.61	110.2	112.05	113.53	114.9
N24@250	188	0.0096	120.42	123.85	126.3	128.26	130.07
N24@200	188	0.012	145.62	150.98	154.81	157.87	160.7
N24@150	188	0.016	183.26	192.79	199.6	205.05	210.08
	$\rho_{st,min}$ [8.1.6.1.(2)]		0.0021	0.0024	0.0027	0.0030	0.0034

$\phi M_u = \phi(f_y \rho b d^2 (1 - 0.6 \rho f_y / f'_c))$   
 \*Tension bars one face  
 #for non-ductile walls only

## RW256S Standard Double Reinforcement Lintels with Vertical PVC Webs

UDL capacity of a simple standard double reinforcement lintel with minimum reinforcement other than extra top and bottom bars shown. Designer can utilise the slab over as T-beam, extra horizontal or vertical shear reinforcement if extra strength is required.

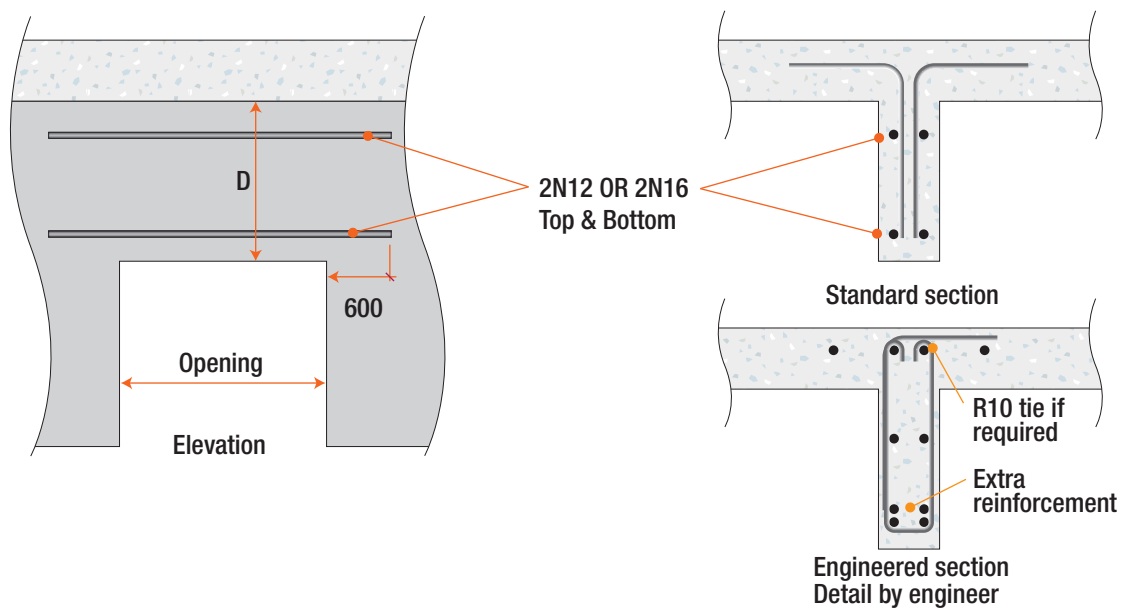

## RW256S Standard Double Reinforcement Lintels with Vertical PVC Webs w\*(kN/m)

D	2N12 Top & Bottom, Depth (mm)				2N16 Top & Bottom, Depth (mm)			
	150	300	450	750	150	300	450	750
d <sub>eff</sub>	50	200	350	650	50	200	350	650
Span (mm)								
3600	9.5	19.7	29.9	50.3	15.7	33.8	50.8	88.0
3300	11.3	23.4	35.5	59.8	18.7	37.8	57.2	104.7
3000	13.6	28.3	43.0	72.4	21.4	42.5	65.4	126.4
2700	16.8	35.0	53.1		24.0	48.6	76.3	
2400	21.3	44.2	67.2		27.5	56.7	91.5	
2100	27.8	57.8	87.8		32.0	68.0	114.4	
1800	37.9	78.7			38.5	85.1		
1500	48.1	113.3			48.1	113.4		
1200	64.1				64.1			
900	96.1				96.1			
	$f'_c = 25\text{MPa}, 50 \text{ cover (min)}$				$f'_c = 25\text{MPa}, 50 \text{ cover (min)}$			
	= $\phi V_{uc}$ governs, otherwise $\phi M_u$							
	= Design to AS3600–2018 Sect 12							

## RW256S In-plane Shear Along Vertical PVC Webs

## RW256S PVC Profile/Spacing

t <sub>w</sub>	S <sub>punch</sub>	N <sub>layers</sub>	A <sub>c</sub>	Align	Bar Max	Min Reo	Max Spacing	t <sub>w, shear</sub>	μ	k <sub>co</sub>
251	240	2	48.6%	100%	20	0.0025	350	121.5	0.35	0.19

RW256S In Plane Shear along Vertical PVC Web  $\phi V_u$  (kN/m)

Horizontal Bars	ρ	25 MPa	32 MPa	40 MPa	50 MPa	65 MPa <sup>#</sup>
2N12@360	0.0025	185.0	195.8	206.7	219.0	235.2
2N12@240	0.0038	236.5	247.2	258.2	270.4	286.7
2N16@360	0.0045	265.2	275.9	286.9	299.1	315.4
2N16@240	0.0067	356.8	367.5	378.5	390.7	407.0
2N20@360	0.0070	368.1	378.9	389.9	402.1	418.4
2N20@240	0.0105	455.6	522.0	532.9	545.2	561.4
2N16@120	0.0134	–	583.2	653.2	665.5	681.7
2N20@120	0.0209	–	–	729.0	911.3	911.3
Max. Shear		455.6	583.2	729.0	911.3	911.3

$$\phi V_u = \phi (\mu \rho t_w f_y + k_{co} t_w f'_{ct})$$

$$\phi V_{max} = \phi 0.2 f'_c t_w \text{ shear} < \phi 10 t_w \text{ shear}$$

# for non-ductile walls only.

## RW275S Structural Capacities

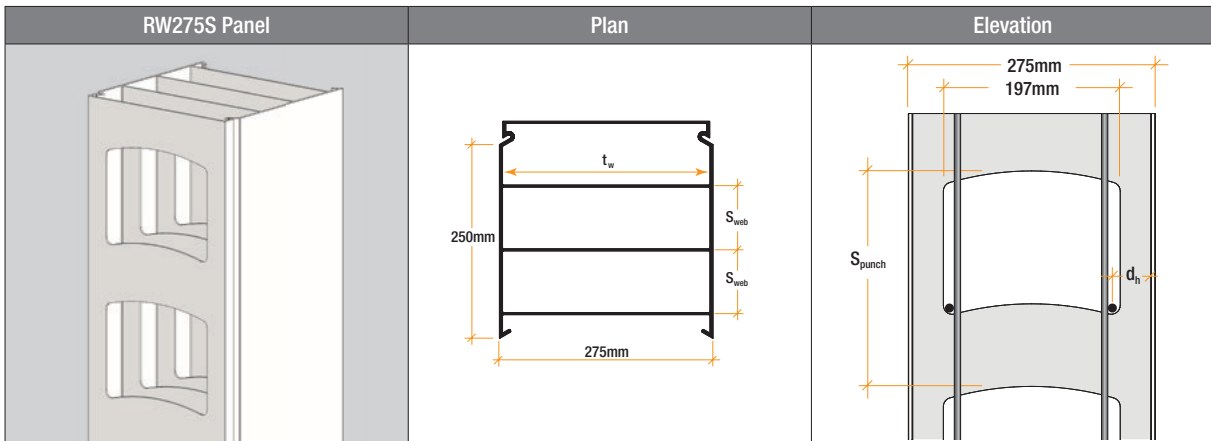

### RW275S Axial Capacity $\phi N_u$ (kN/m) Non-Ductile (2-Layers)

$t_w$	$t_{fire}$	$S_{web}$	$S_{punch}$	$A_c$	$N_{layers}$	$d_h$	$f'_{c,max}$
270	270	79	240	51.8%	2	41	65

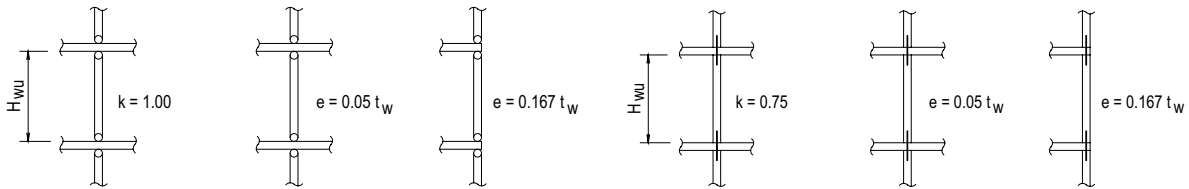

$k = 0.75$	$H_{wu}$	$H_{we}$	Continuous Floor $e = 0.05 t_w$				Discontinuous Floor $e = 1/6 t_w$			
			25 MPa	32 MPa	40 MPa	50 MPa	25 MPa	32 MPa	40 MPa	50 MPa
	6000	4500	1671	2139	2674	3342	1329	1701	2126	2657
	5000	3750	1863	2385	2981	3727	1521	1947	2433	3042
	4500	3375	1946	2491	3114	3893	1604	2053	2566	3208
	4200	3150	1992	2550	3187	3984	1649	2111	2639	3299
	3900	2925	2035	2604	3255	4069	1692	2166	2707	3384
	3600	2700	2074	2655	3318	4148	1731	2216	2770	3463
	3300	2475	2110	2701	3376	4220	1767	2262	2828	3535
	3000	2250	2143	2743	3429	4286	1800	2305	2881	3601
	2700	2025	2173	2781	3477	4346	1830	2343	2929	3661
	2400	1800	2200	2816	3520	4399	1857	2377	2971	3714
	2100	1575	2223	2846	3557	4447	1881	2407	3009	3761
	1800	1350	2244	2872	3590	4488	1901	2433	3042	3802
Bearing capacity at standard bottom plate			2362	3024	3780	4724	2362	3024	3780	4724

### RW275S Minimum Reinforcement

RW275S		Vertical Bars - Each Face (min. N12-330)				
Allowable Bars		N12	N16	N20	N24	N28
Horizontal (min. N12-350)	N12	Acceptable	Acceptable	Acceptable	Acceptable	Acceptable
	N16	Acceptable	Acceptable	Acceptable	Acceptable	Acceptable
	N20	With Caution	With Caution	With Caution	With Caution	Not Recommended
	N24	Not Recommended	Not Recommended	Not Recommended	Not Recommended	Not Recommended

Horizontal Bar Spacing 240  
Vertical Bar Spacing 150 to 350

Acceptable
With Caution
Not Recommended

### RW275S Standard Double Reinforcement Lintels with Vertical PVC Webs

UDL capacity of a simple standard double reinforcement lintel with minimum reinforcement other than extra top and bottom bars shown. Designer can utilise the slab over as T-beam, extra horizontal or vertical shear reinforcement if extra strength is required.

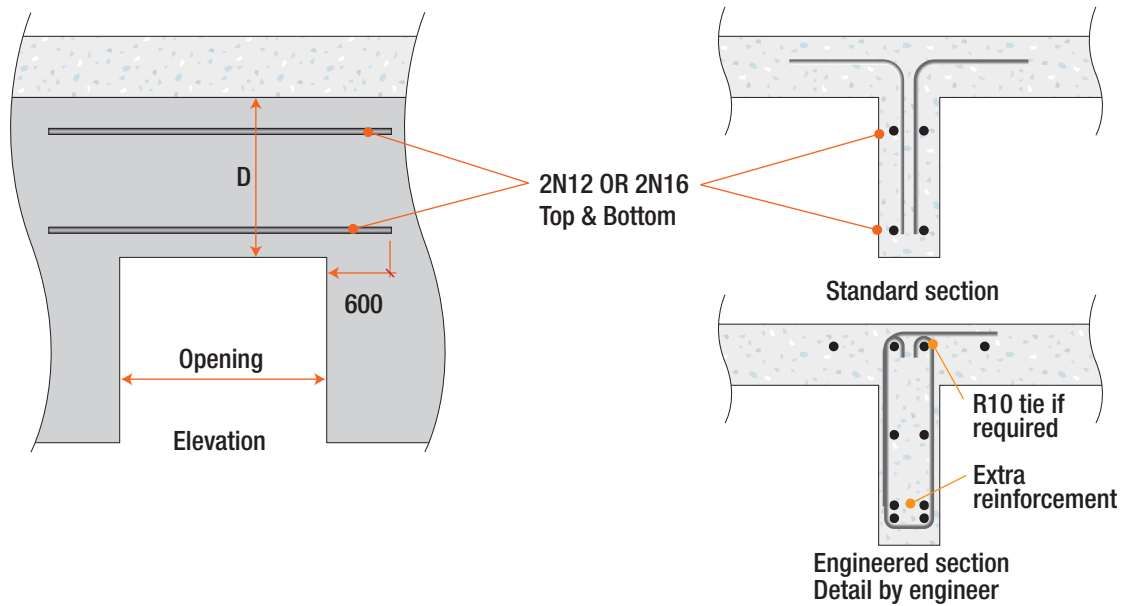

### RW275S Standard Double Reinforcement Lintels with Vertical PVC Webs $w^*$ (kN/m)

D	2N12 Top & Bottom, Depth (mm)				2N16 Top & Bottom, Depth (mm)			
	150	300	450	750	150	300	450	750
$d_{eff}$	50	200	350	650	50	200	350	650
Span (mm)								
3600	9.5	19.7	29.9	50.3	15.9	34.0	52.0	88.1
3300	11.3	23.5	35.6	59.9	18.9	40.4	61.9	104.9
3000	13.7	28.4	43.1	72.5	22.9	48.8	74.9	126.9
2700	16.9	35.1	53.2		27.6	55.7	87.4	
2400	21.4	44.4	67.3		31.5	65.0	104.9	
2100	28.0	57.9	87.9		36.8	78.0	131.2	
1800	38.1	78.9			44.1	97.5		
1500	54.8	113.6			55.1	130.1		
1200	73.5				73.5			
900	110.3				110.3			
	$f'_c = 25\text{MPa}, 50 \text{ cover (min)}$				$f'_c = 25\text{MPa}, 50 \text{ cover (min)}$			
	= $\phi V_{UC}$ governs, otherwise $\phi M_U$ = Design to AS3600–2018 Sect 12							



## RW275S In-plane Shear Along Vertical PVC Webs

### RW275S PVC Profile/Spacing

$t_w$	$S_{punch}$	$N_{layers}$	$A_c$	Align	Bar Max	Min Reo	$t_{w, shear}$
269	240	2	51.8%	100.0%	20	0.0025	139.3

### RW275S In Plane Shear along Vertical PVC Web $\emptyset V_u$ (kN/m)

Horizontal Bars	$\rho$	25 MPa	32 MPa	40 MPa	50 MPa	65 MPa <sup>#</sup>
2N12@240	0.0035	258.7	271.0	283.6	297.6	316.3
2N16@360	0.0042	289.3	301.6	314.2	328.2	346.9
2N16@240	0.0062	386.9	399.2	411.8	425.8	444.5
2N20@360	0.0065	399.0	411.4	423.9	438.0	456.6
2N20@240	0.0097	522.5	563.9	576.4	590.5	609.1
2N16@120	0.0125	–	668.8	704.6	718.7	737.3
2N20@120	0.0195	–	–	836.1	1045.1	1045.1
Max. Shear		522.5	668.8	836.1	1045.1	1045.1
$\emptyset V_u = \emptyset(\mu P t_w f_y + k_{co} t_w f'_{ct})$						
$\emptyset V_{max} = \emptyset 0.2 f'_c t_w shear < \emptyset 10 t_w shear$						
# for non-ductile walls only.						

## RW300S Structural Capacities

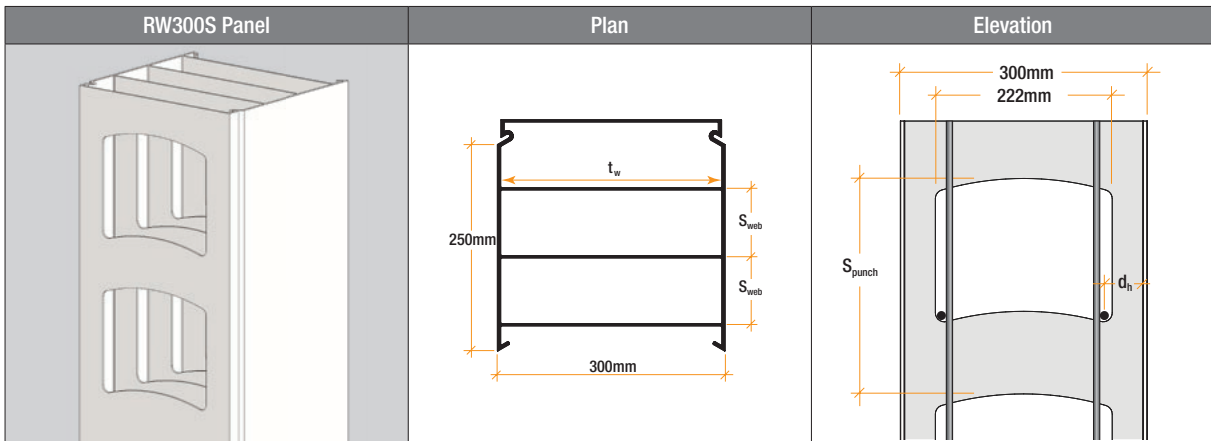

### RW300S Axial Capacity $\phi N_u$ (kN/m) Non-Ductile (Layers)

$t_w$	$t_{fire}$	$S_{web}$	$S_{punch}$	$A_c$	$N_{layers}$	$d_h$	$f'_{c,max}$
295	295	79	240	51.8%	2	41	65

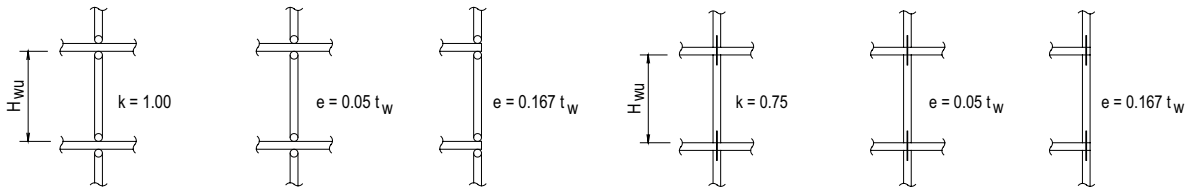

$k = 0.75$	$H_{WU}$	$H_{We}$	Continuous Floor $e = 0.05t_w$				Discontinuous Floor $e = 1/6t_w$			
			25 MPa	32 MPa	40 MPa	50 MPa	25 MPa	32 MPa	40 MPa	50 MPa
	6000	4500	2223	2845	3557	4446	1814	2321	2902	3627
	5000	3750	2384	3051	3814	4768	1974	2527	3159	3949
	4500	3375	2453	3140	3925	4907	2044	2616	3270	4088
	4200	3150	2492	3189	3986	4983	2082	2665	3331	4164
	3900	2925	2527	3235	4043	5054	2118	2710	3388	4235
	3600	2700	2560	3277	4096	5120	2150	2753	3441	4301
	3300	2475	2590	3315	4144	5180	2181	2791	3489	4361
	3000	2250	2618	3351	4189	5236	2208	2827	3533	4417
	2700	2025	2643	3383	4229	5286	2233	2859	3573	4467
	2400	1800	2665	3412	4264	5331	2256	2887	3609	4512
	2100	1575	2685	3437	4296	5370	2276	2913	3641	4551
	1800	1350	2702	3459	4323	5404	2293	2935	3668	4585
Bearing capacity at standard bottom plate			2915	3731	4664	5830	2915	3731	4664	5830

### RW300S Minimum Reinforcement

RW300S		Vertical Bars - Each Face (min. N12-330)				
Allowable Bars		N12	N16	N20	N24	N28
Horizontal (min. N12-350)	N12	Acceptable	Acceptable	Acceptable	Acceptable	Acceptable
	N16	Acceptable	Acceptable	Acceptable	Acceptable	Acceptable
	N20	With Caution	With Caution	With Caution	With Caution	Not Recommended
	N24	Not Recommended	Not Recommended	Not Recommended	Not Recommended	Not Recommended

Horizontal Bar Spacing 240  
Vertical Bar Spacing 150 to 350

Acceptable
With Caution
Not Recommended

### RW300S Standard Double Reinforcement Lintels with Vertical PVC Webs

UDL capacity of a simple standard double lintel with minimum reinforcement other than extra top and bottom bars shown. Designer can utilise the slab over as T-beam, extra horizontal or vertical shear reinforcement if extra strength is required.

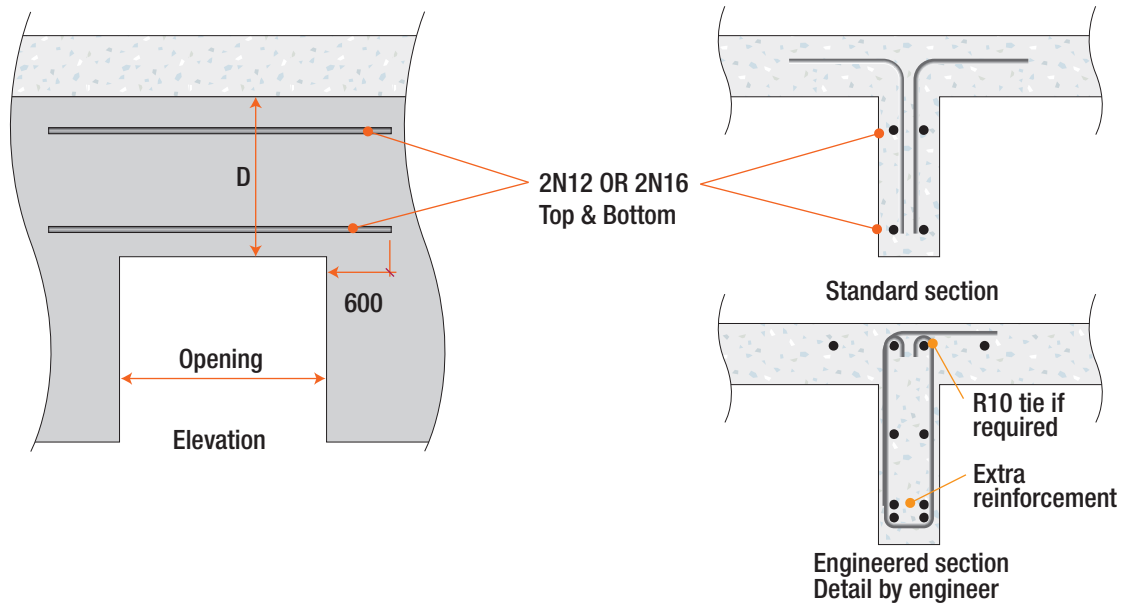

### RW300S Standard Double Reinforcement Lintels with Vertical PVC Webs $w^*(\text{kN/m})$

D	2N12 Top & Bottom, Depth (mm)				2N16 Top & Bottom, Depth (mm)			
	150	300	450	750	150	300	450	750
$d_{\text{eff}}$	50	200	350	650	50	200	350	650
Span (mm)								
3600	9.5	19.7	29.9	50.3	15.9	34.0	52.1	88.2
3300	11.3	23.5	35.6	59.9	19.0	40.5	62.0	104.9
3000	13.7	28.4	43.1	72.5	23.0	49.0	75.0	127.0
2700	16.9	35.1	53.2		28.1	56.8	89.1	
2400	21.4	44.4	67.3		32.1	66.2	106.9	
2100	28.0	58.0	88.0		37.4	79.5	133.6	
1800	38.1	78.9			44.9	99.4		
1500	54.9	113.6			56.2	132.5		
1200	74.9				74.9			
900	112.3				112.3			
	$f'_c = 25\text{MPa}, 50 \text{ cover (min)}$				$f'_c = 25\text{MPa}, 50 \text{ cover (min)}$			
	= $\phi V_{uc}$ governs, otherwise $\phi M_u$ = Design to AS3600–2018 Sect 12							

## RW300S In-plane Shear Along Vertical PVC Webs

### RW300S PVC Profile/Spacing

$t_w$	$S_{punch}$	$N_{layers}$	$A_c$	Align	Bar Max	Min Reo	$t_{w, shear}$
274	240	2	51.8%	100%	20	0.0025	141.9

### RW300S In Plane Shear along Vertical PVC Web $\phi V_u$ (kN/m)

Horizontal Bars	$\rho$	25 MPa	32 MPa	40 MPa	50 MPa	65 MPa <sup>#</sup>
2N12@240	0.0034	260.4	273.0	285.8	300.1	319.1
2N16@360	0.0041	291.0	303.6	316.4	330.7	349.7
2N16@240	0.0061	388.6	401.2	414.0	428.3	447.3
2N20@360	0.0064	400.8	413.4	426.2	440.5	459.5
2N20@240	0.0095	532.2	565.8	578.6	592.9	611.9
2N16@120	0.0122	–	681.3	706.8	721.2	740.1
2N20@120	0.0191	–	–	851.6	1050.4	1064.5
Max. Shear		532.2	681.3	851.6	1064.5	1064.5
$\phi V_u = \phi(\mu \rho t_w f_y + k_{co} t_w f'_{ct})$						
$\phi V_{max} = \phi 0.2 f'_c t_w shear < \phi 10 t_w shear$						
# for non-ductile walls only.						

# Non-Ductile Wall Detailing

---

Standard AFS Wall Detailing for Non-Ductile Wall Designs in accordance with AS3600-2018 Section 2.2

and the relevant clauses in Section 14.4.

## Junctions

In general Wall Junctions are not required to transfer in plane Lateral or Shear loads across the junctions. Where transfer of in-plane Lateral or Shear loads across junctions is required the Project Engineer is

to specify the AFS Special Junction Details on the Structural Documentation. If detailing is required beyond these special junctions AFS Technical Support is to be consulted and detailing reviewed.

## Standard Wall Junctions

Standard junctions are used except where the structural documentation indicates otherwise. Core Walls would generally be specified with special Junctions.

## Standard Junctions Details – Single Reinforcement

AFS Standard Junction Detailing is used unless alternate AFS details are specified in the Project Documentation. If Junction Details beyond the details provided in this manual are to be used, then AFS Technical Support is to be consulted and detailing reviewed.

**Fig A1: Standard Cross Junction**

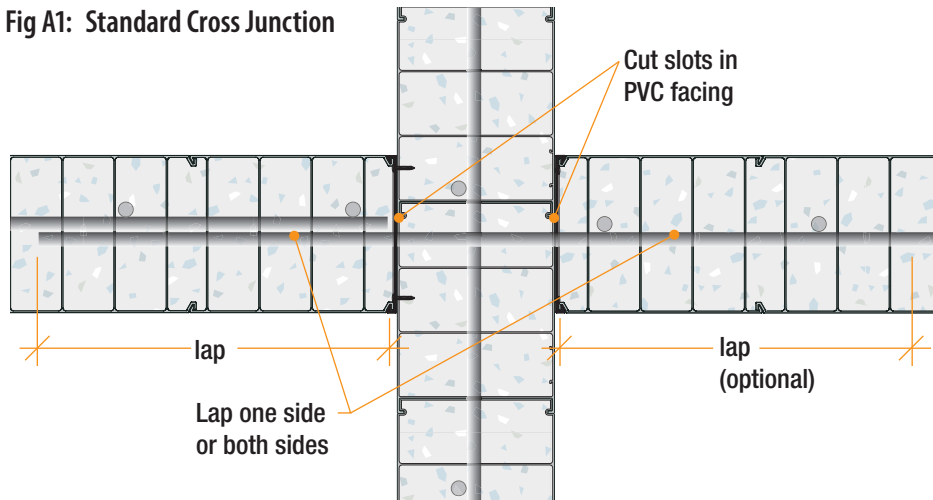

**Fig A2: Standard Corner 90°**

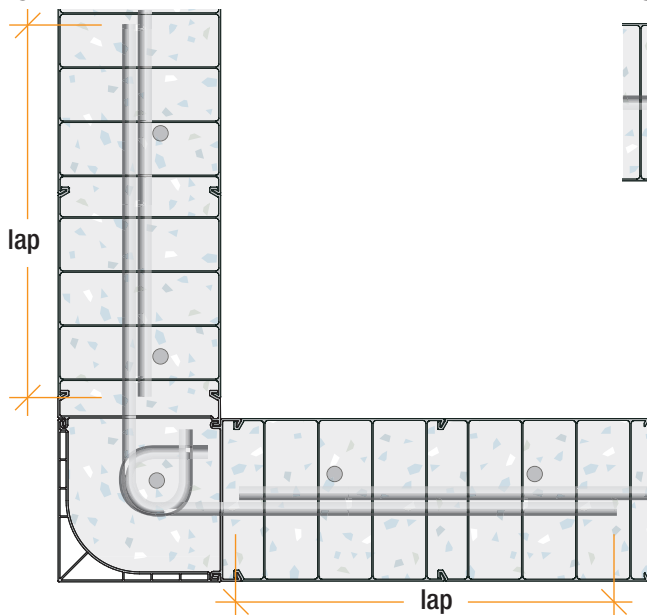

**Fig A3: Standard T-Junction**

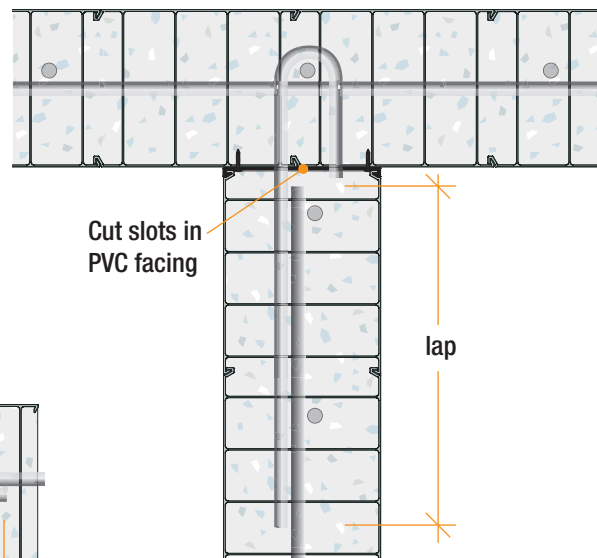

**Fig A4: Standard Angled Junction**

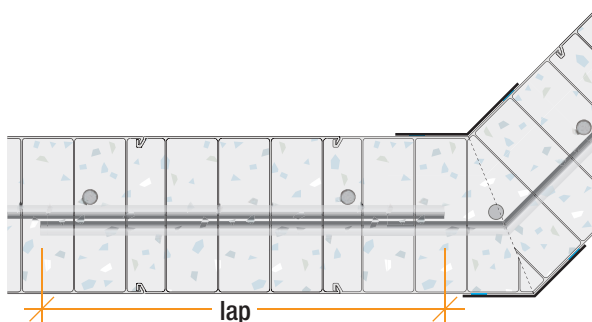

**Fig A5: Standard Hook Bars and Lap Details**

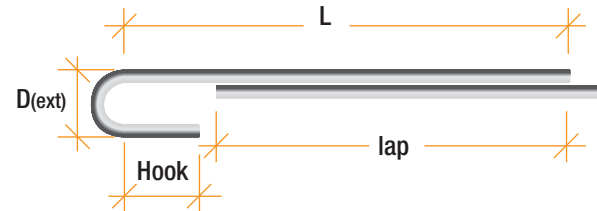

**Standard Hook Bar (mm)**

Reo	D	L	Hook	Lap	RW110C	RW156C	RW200C
N12	60	550	70	450	Y	Y	Y
N16	80	700	70	600	N	N	Y
					Acceptable		
					Not Recommended		

## Standard Junctions Details – Double Reinforcement

Where Boundary Elements are required, provide laps 1.2 x L, compliant with AS3600-2018 Amdt 2, refer to Standard U-Bar table.

Fig A6: Standard Cross Junction

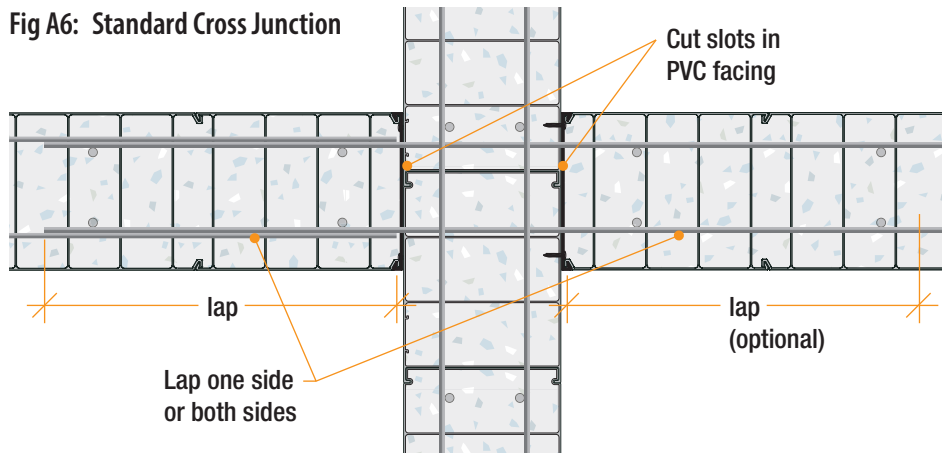

Fig A7: Standard Corner 90°

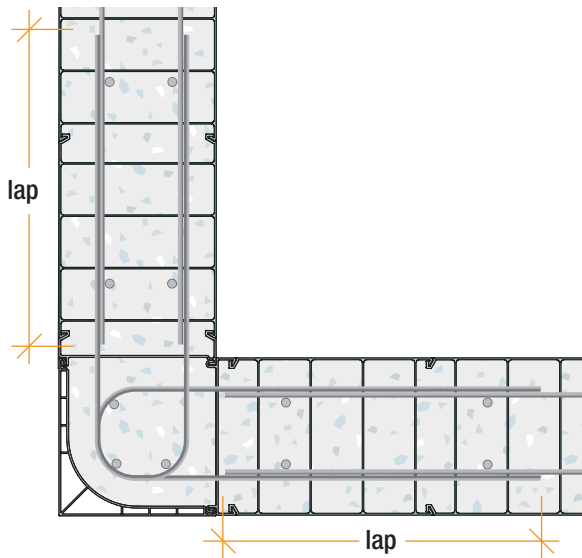

Fig A8: Standard T-Junction

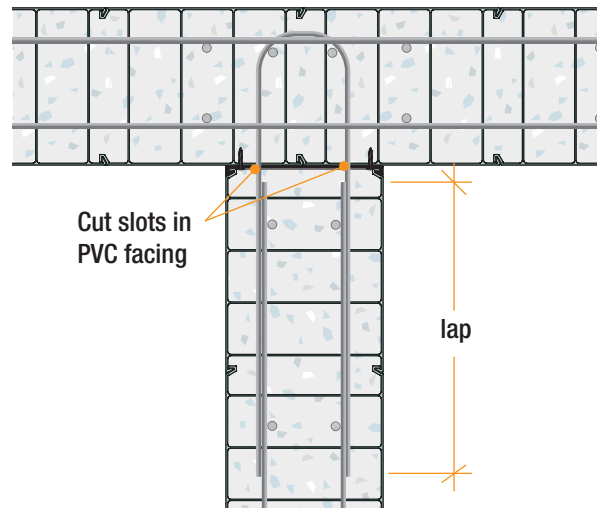

Fig A9: Standard Angled Junction

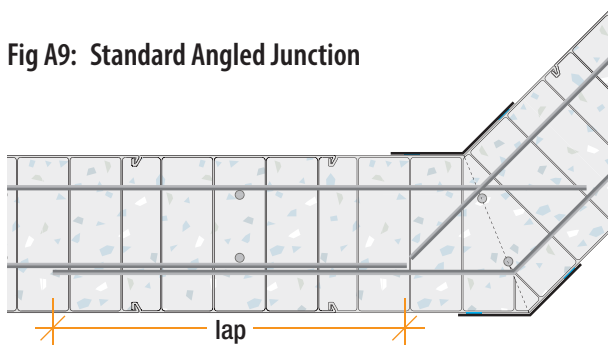
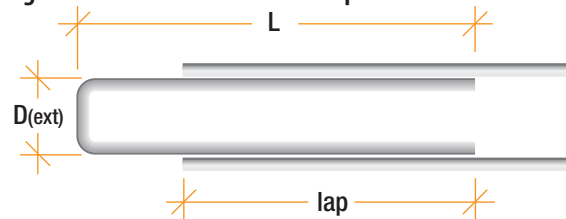

Fig A10: Standard U-Bars and Lap Details



Standard U Bar

Wall Type	Reo	Standard U-Bars			Boundary Element U-Bars		
		Lap	D	L	Lap	D	L
RW200C	N12	450	105	750	500	105	750
RW256S	N12	450	155	750	500	155	750
RW256S	N16	600	155	900	800	155	1050
RW275S	N12	450	175	750	500	155	750
RW275S	N16	600	175	900	800	155	1050
RW300S	N12	450	205	750	500	155	750
RW300S	N16	600	205	900	800	155	1050

## Non-Ductile Blade Walls/Columns

AFS uses the following definitions for Blade Walls/Columns, with typical standardised reinforcement detailing that is compliant to AS3600-2018

### Blade walls

Blade walls are short walls designed as non-ductile walls without ligatures in accordance with Section 11 of AS3600-2018. They are generally loaded concentrically, with concrete strength not greater than 50MPa and have no net tension in the strong or weak axis.

### Blade wall

Detail to AS3600-2018 Section 11 (where applicable).

**Fig A11: Rediwall® Blade Wall**

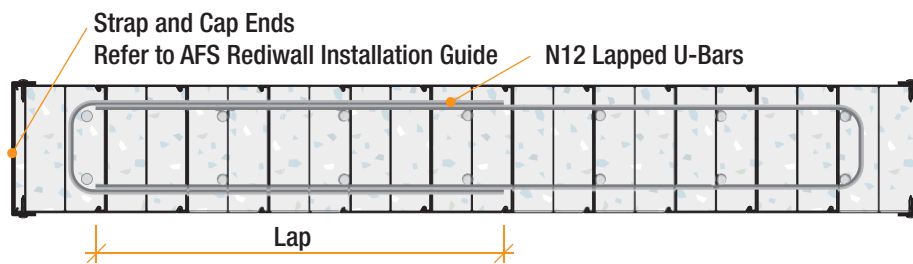

### Blade Column

Detail to AS3600-2018 Section 10 (where applicable).

**Fig A12: Rediwall® Blade Column**

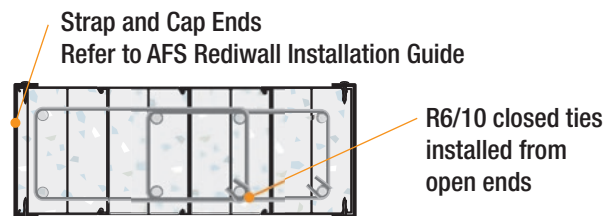



## Movement Joints

The structural concrete wall effectively has 'control joints' at each plastic web so no additional crack control joints are necessary. Full depth 'movement joints' may be required depending on the geometry of the structure and other considerations such as thermal loads, exposure and building joints. Movement joints shall be placed in locations nominated by the structural engineer and must be documented on structural drawings. These will be installed at construction stage by the rediwall® installation contractor. As a guide the engineer should review joint reinforcement requirements for wall runs longer than 16 metres. Refer to Fig A13.

**Fig A13: Movement Joint Non-Ductile Design Detail**

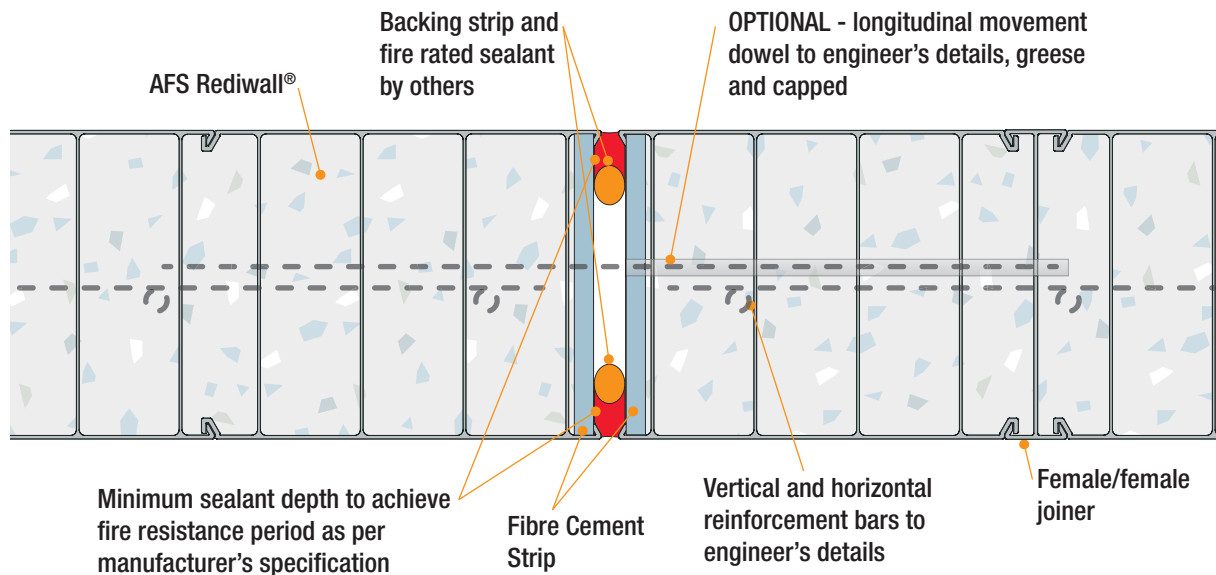

**Note:** Can be dowel jointed if required structurally. Must be clearly specified and negotiated with installers at time of tender. Installed where nominated by project engineer. Must be clearly documented on drawings.

# Limited Ductile Wall Design

## Limited Ductile Design

AFS Rediwall® can be designed to the requirements of AS3600-2018 Limited Ductile Walls. Limited Ductile Walls are to be designed to Section 2.2, Clause 14.4 and Clause 14.6 of AS3600-2018. Clause 14.6.1 requires the Limited Ductile walls to have reinforcement on each face and be detailed in accordance with the requirements of Clause 14.6.

Refer to the following sections for standard detailing to suit Rediwall® Limited Ductile Walls with boundary elements.

It is recommended that AFS Limited Ductile Walls are only to be installed by experienced installers due to the additional detailing requirements. AFS detailing is to be used unless AFS Technical Support reviews and approves alternate detailing.

Below is a sample Moment Interaction curve showing RW200C capacity without core confinement.

**Fig A14: Sample Moment Interaction**

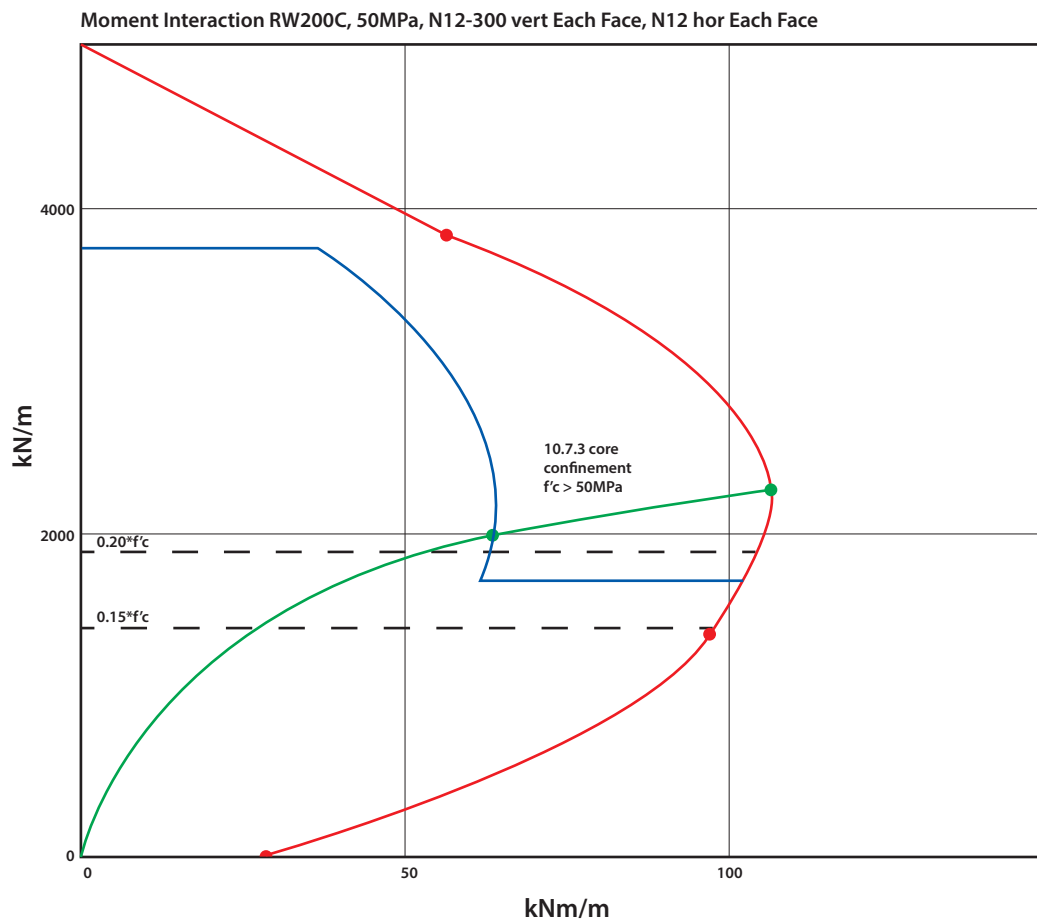

## Limited Ductile Design Examples

The following tables provides other design examples for Rediwall® sizes over a range of reinforcement and concrete strengths.

RW200C Panel	Plan	Elevation
		
		
		
		

TABLE A2: Rediwall® Panel Properties

Wall Type	$t_w$	$S_{web}$	$S_{punch}$	$N_{layers}$	$A_c$	Slender. Limit	$d_h$	Min Reo	$f'_{c,max}$
RW200C	195	66.6	116.7	2	50.1%	30	39	N12-350hor. N12-300 vert.	50
RW256S	250	73.5	240	2	48.6%	30	45	N12-350hor. N12-300 vert.	50
RW275S	269	75.0	240	2	51.8%	30	45	N12-233hor. N12-300 vert.	50
RW300S	274	75.0	240	2	51.8%	30	45	N12-233hor. N16-300 vert.	50

TABLE A3: Rediwall® Design Axial Forces

Wall Description	C11.7.4 restraints not required	$H_{wu}$ $k = 0.75$ mm	$t_w$ mm	$d_c$ mm	$p_{vert}$ %	$\phi N_u$ kN/m	14.3.2.1 $0.20 \cdot f'_c$ kN/m	$\phi M_u$ kNm/m
RW200C (194), 32MPa, N12-300 vert. Each Face, N12 hor.	Each Face ( $\leq 1\%$ )	3000	194	50.5	0.39	1760	1242	31
RW200C (194), 50MPa, N16-200 vert. Each Face, N12 hor.	Each Face ( $\leq 1\%$ )	3000	194	52.5	1.0	2730	1455	65
RW200C (194), 50MPa, N20-175 vert. Each Face, N12 hor.	EF Tens. Only	3000	194	54.5	1.9	2930	1455	69
RW256S (250), 32MPa, N12-300 vert. Each Face, N12 hor.	Each Face ( $\leq 1\%$ )	3000	250	56.8	0.30	3040	1200	52
RW256S (250), 50MPa, N20-250 vert. Each Face, N12 hor.	Each Face ( $\leq 1\%$ )	3000	250	60.8	1.0	4820	1875	110
RW256C (250), 50MPa, N28-200 vert. Each Face, N16 hor.	EF Tens. Only	3000	250	66.8	2.5	5440	1875	125
RW275S (269), 32MPa, N12-250 vert. Each Face, N12 hor.	Each Face ( $\leq 1\%$ )	3000	269	57	0.34	3470	1291	62
RW275S (269), 50MPa, N28-200 vert. Each Face, N16 hor.	EF Tens. Only	3000	269	67	2.3	6150	2018	148
RW300S (294), 32MPa, N16-300 vert. Each Face, N12 hor.	Each Face ( $\leq 1\%$ )	3000	294	45	0.46	4110	1411	82
RW300S (294), 50MPa, N28-200 vert. Each Face, N16 hor.	EF Tens. Only	3000	294	45	2.1	7370	2205	209

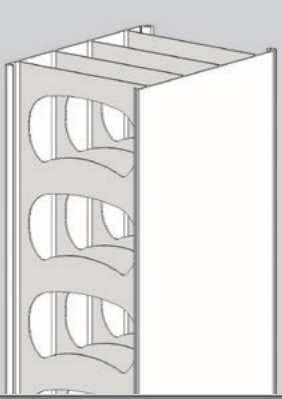
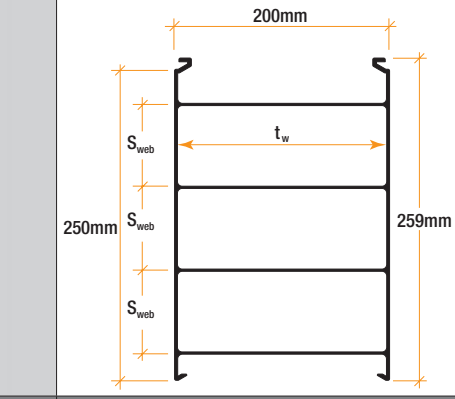
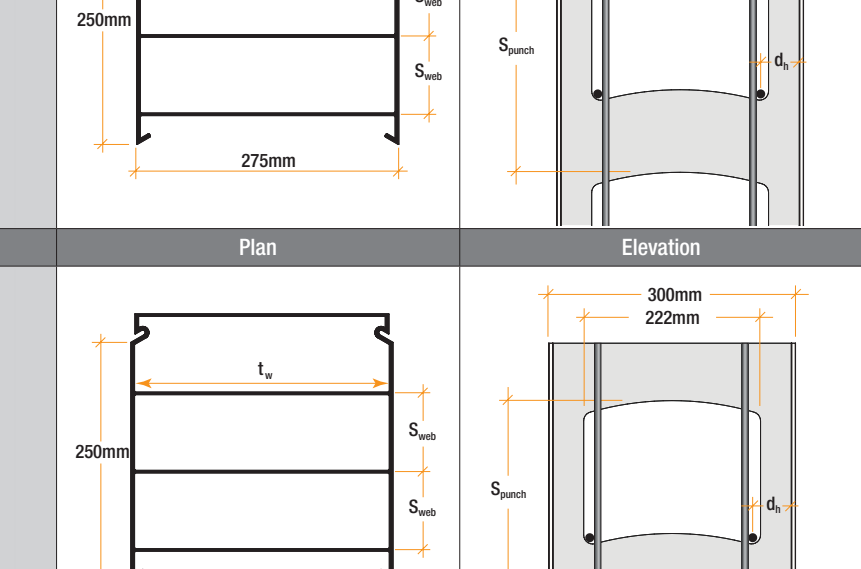
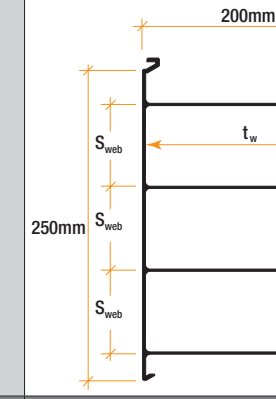
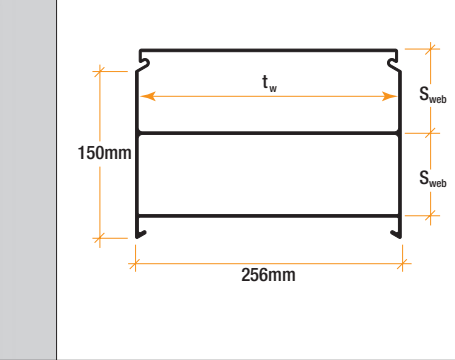
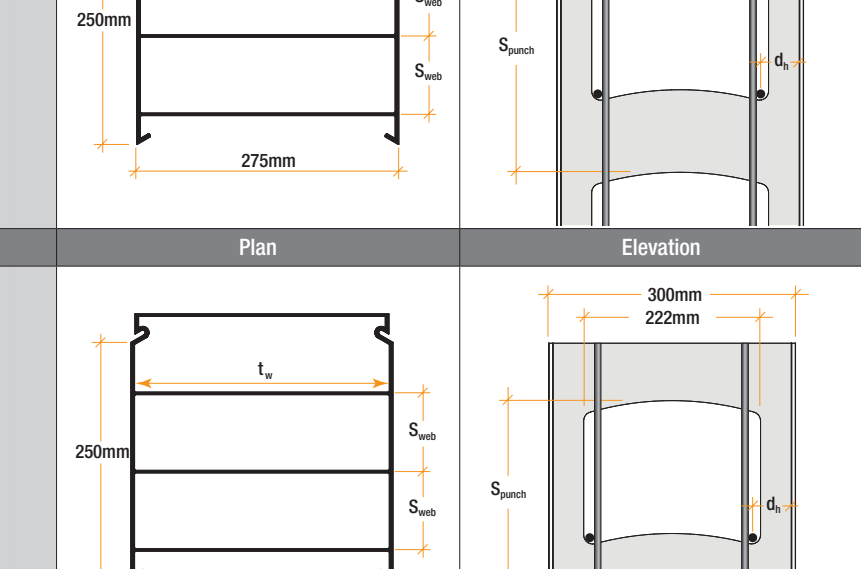
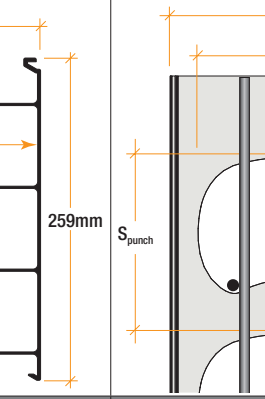
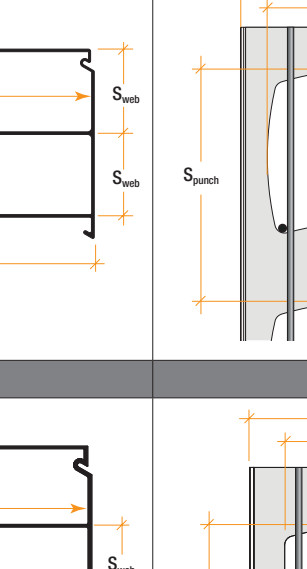
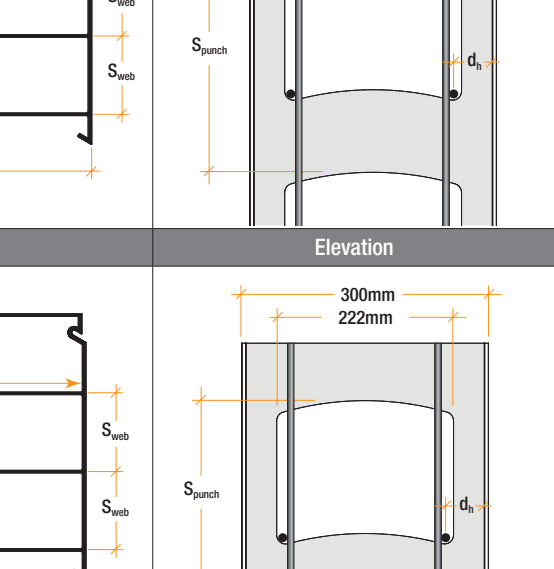
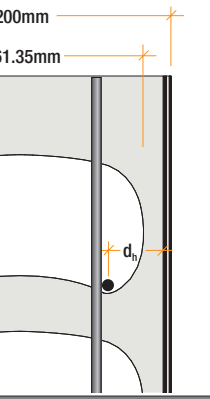
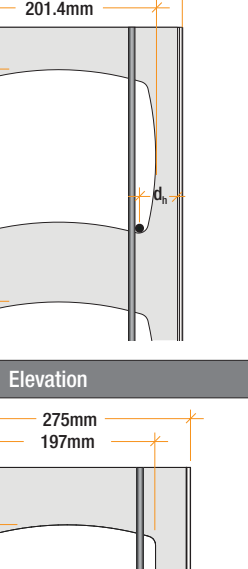
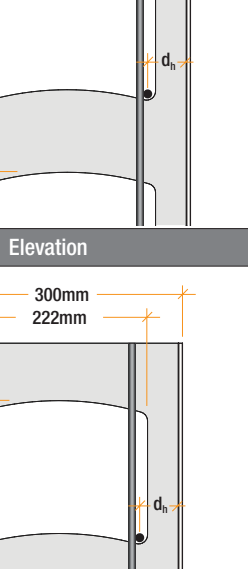
# Limited Ductile Wall Detailing

Standard afs rediwall® Detailing for Limited Ductile Wall Designs in accordance with AS3600-2018 Section 2.2 and Clauses in 14.4 and 14.6. All limited Ductile Walls will have 2 layers of reinforcement.

In general wall fitments are not used in afs rediwall® when designed in accordance to AS3600-2018 Clause 14.6 with  $f'_c \leq 50$  MPa. If fitments are required in small areas outside of boundary elements consult the AFS Technical Support for assistance.

## Boundary Elements

AS3600-2018 Cl14.6.2 Boundary Elements requires boundary elements where extreme fibre compressive stress exceeds  $0.15 f'_c$ . The extent and detailing of the boundary elements are to be determined by the designer.

AFS Rediwall® Boundary Elements have special installation requirements and are only to be installed by AFS approved experienced installers. AFS detailing is to be used unless AFS Technical Support reviews and approves alternate detailing.

## Structures not more than four storeys

'For structures not more than four stories above their structural base and where boundary elements are required' [AS3600 Cl14.6.2.2] the AFS Standard End detail may be used as the boundary element.

AFS Standard Boundary Element will be used at all Boundaries unless specified in the Project Documentation.

## Reinforcement

In accordance with AS3600-2018 Cl14.6.7 maximum vertical reinforcement for afs rediwall® shall be 2.1% ( $\text{Half } 21/f_{sy}$ ) including areas with boundary elements and laps. Minimum horizontal and vertical reinforcement shall be 0.0025.

**Fig A15: AFS Rediwall® Standard Boundary Element Not More Than Four Storeys**

Detail to AS3600-2018 Section 14.6.2.2

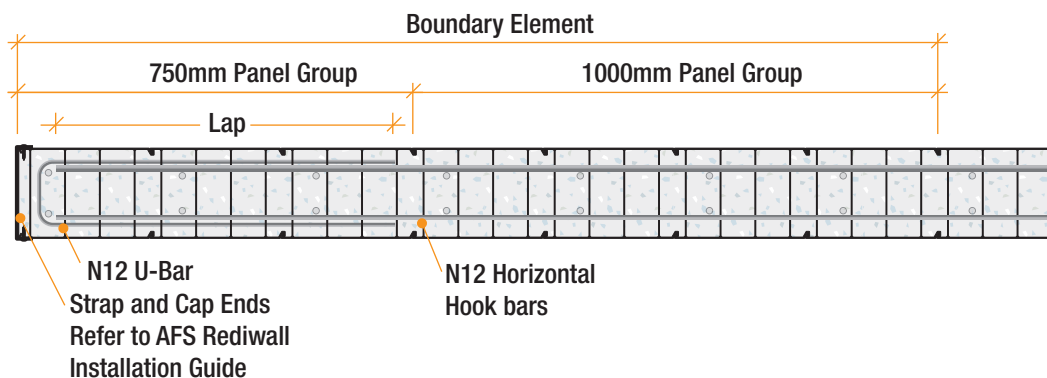

## Structures more than four stories

For structures more than four stories CI14.6.2.3 requires boundary elements to conform to CI10.7.4. The AFS Standard Boundary Element below can be installed during installation of the walls.

**Fig A16: AFS Standard Boundary Element More Than Four Storeys**

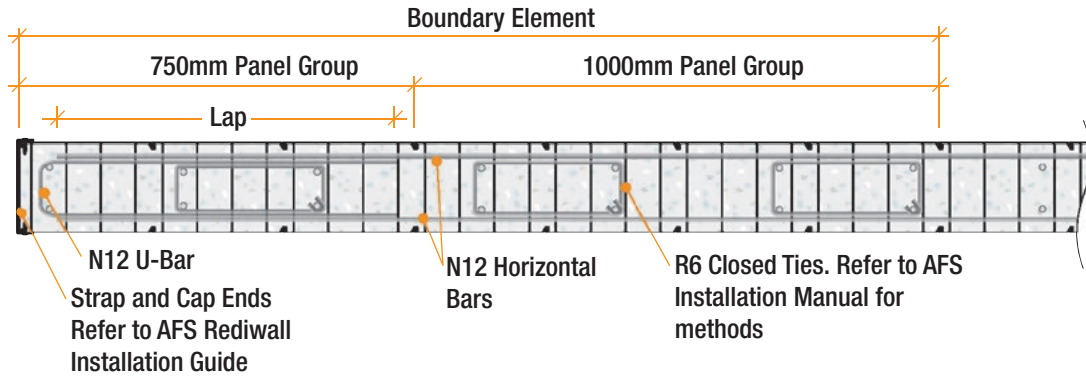

**Fig A17: Standard U-Bars**

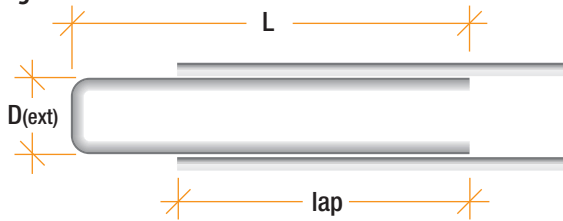

**Standard U Bar**

Wall Type	Reo	Standard U-Bars			Boundary Element U-Bars		
		Lap	D	L	Lap	D	L
RW200C	N12	450	105	750	500	105	750
RW256S	N12	450	155	750	500	155	750
RW256S	N16	600	155	900	800	155	1050
RW275S	N12	450	175	750	500	155	750
RW275S	N16	600	175	900	800	155	1050
RW300S	N12	450	205	750	500	155	750
RW300S	N16	600	205	900	800	155	1050

**Fig A18: Standard Hook Bars**

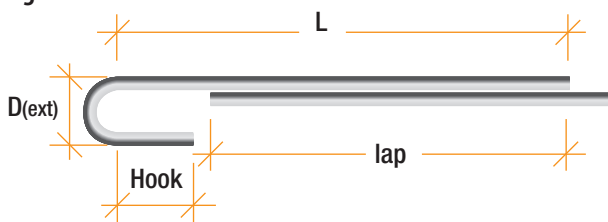

**Standard Hook Bar (mm)**

Reo	D	L	Hook	Lap	RW110C	RW156C	RW200C
N12	60	550	70	450	Y	Y	Y
N16	80	700	70	600	N	N	Y
				Acceptable	Not Recommended		

Boundary elements closed fitments are to be spaced vertically in accordance with Cl 14.6.2 of AS3600-2018 as follows:

- Spaced at lesser of  $t_w$  and 200mm
- For structures more than four stories as per Cl 14.6.2.3 of AS3600-2018.

**Fig A19: AFS Limited Ductile Core Wall Detailing**

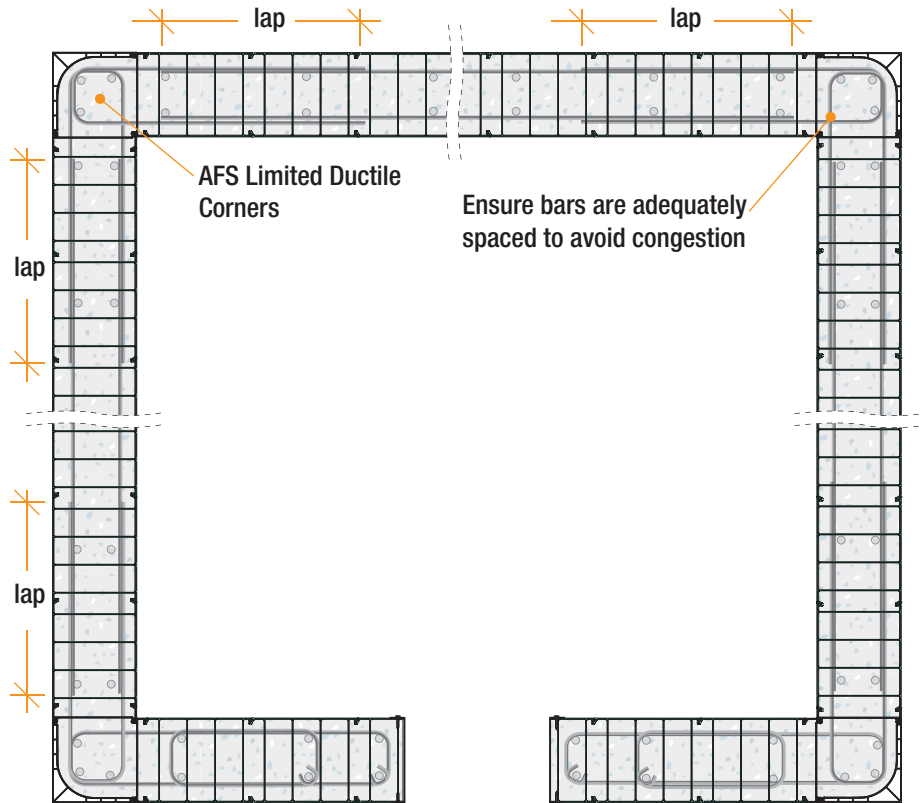

### Limited Ductile Wall – Horizontal Reinforcement Laps

AFS recommends only Fig 14.6.7(D) of AS3600-2018 be used where required.

Alternatives to the 14.6.7 detail are:

- Construction joints to split the walls and prevent transfer of in-plane lateral and shear loads.

**Fig A20: Horizontal Bar Lap Detail 14.6.7(D) from AS3600**

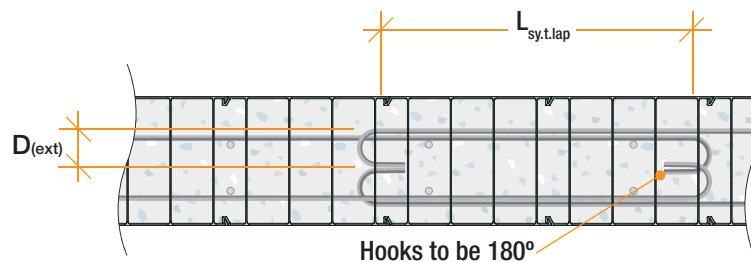

## Blade Columns

Blade Columns are short walls designed as columns with ligatures to AS3600-2018 Sections 14 and 10.

**Fig A21: Rediwall® Blade Column**

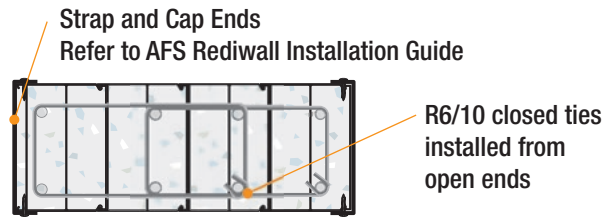

## Junctions

### AFS Standard Junctions

Standard single reinforcement junctions are not to be used with Limited Ductile Walls. Junction Joints may be used to structurally isolate walls either side of the junction and prevent transfer of in-plane forces

### AFS Special Junctions

Structural Documentation is to specify where Special Junctions are to be used. If detailing is required beyond these special junctions AFS Technical Support is to be consulted and detailing reviewed.

## Special Limited Ductile Junction Details – Without Boundary Elements

**Fig A22: Corner Type 1**

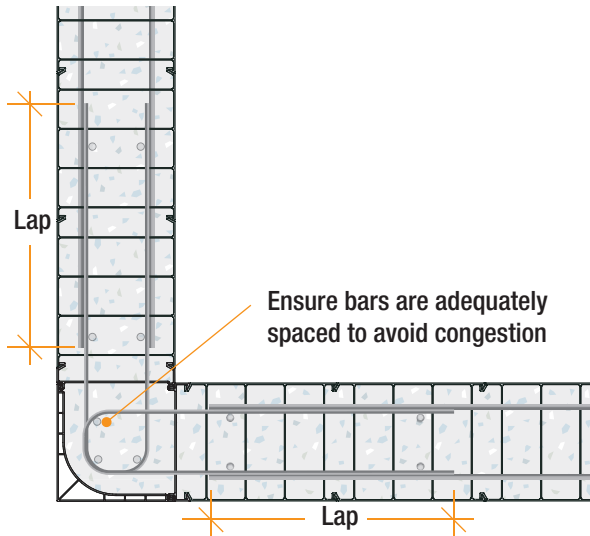

**Fig A23: Special T-Junction**

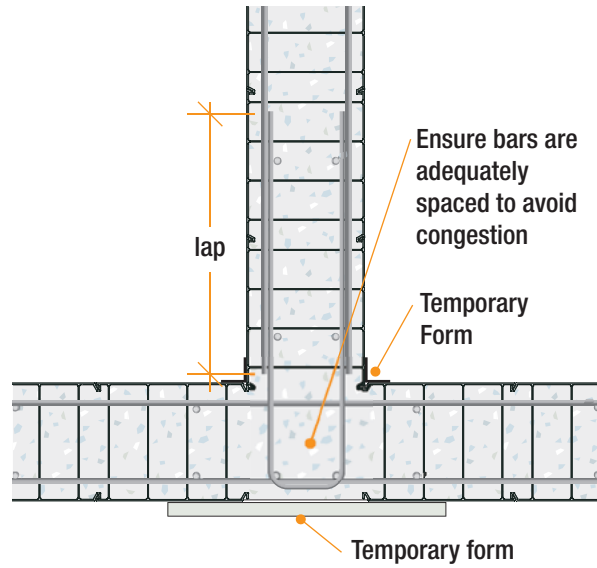

**Fig A24: LD Special Angle Junction**

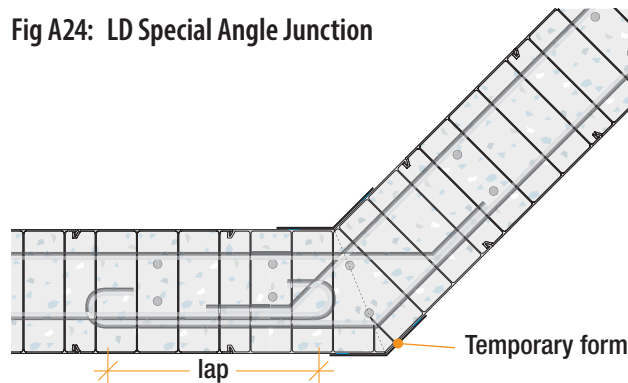



## Movement Joints

Movement Joints will be required over any building joints and where specified on the Project Documentation

The structural concrete wall effectively has control joints at each stud so no additional crack control joints are necessary. Full depth 'movement joints' may be required depending on the geometry of the structure and other considerations such as thermal loads,

exposure and building joints. In general 'movement joints' would not be required for walls less than 16m long. Structural movement joints will be placed in locations nominated by the structural engineer and must be documented on structural drawings. These will be installed at construction stage by the afs rediwall® installation contractor.

**Fig A25: Rediwall® Movement joint**

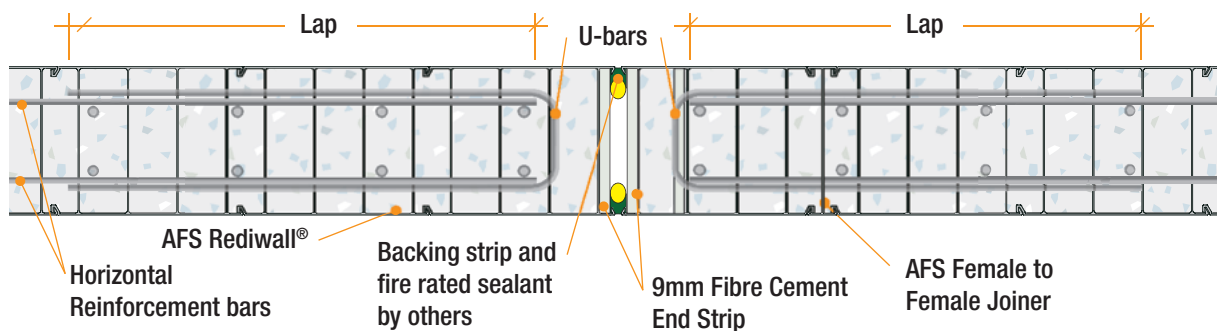

**Note:** Installed where nominated by project engineer. Must be clearly documented on drawings. Typically not required in walls less than 16m in length.

## Construction Joint

Construction Joints can be used wherever a pour break is required. Walls may be split to prevent transfer

of in-plane forces. Locations are to be specified on the Project Documentation.

**Fig A26: Rediwall® Construction Joint**

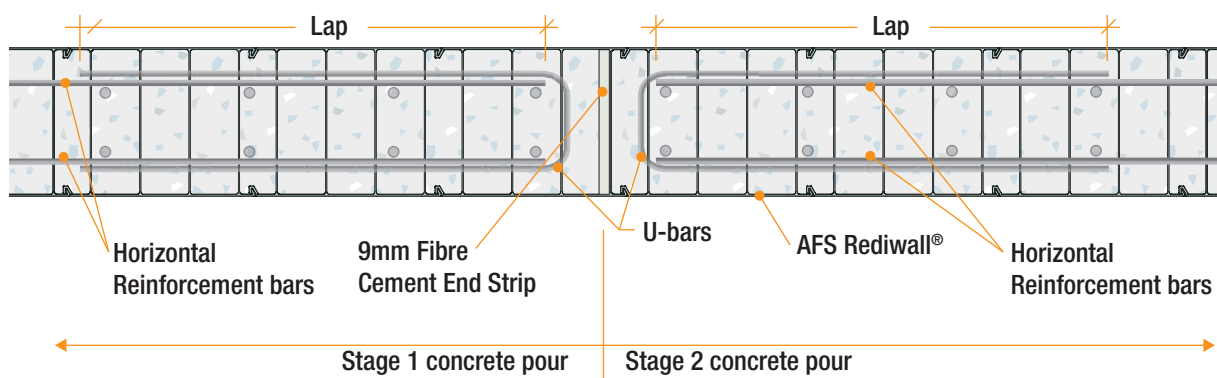

## Wall Junctions Joints

Junction Joints to structurally isolate walls either side of the junction and prevent transfer of inplane forces.

Fig A27: Rediwall® Corner Joint

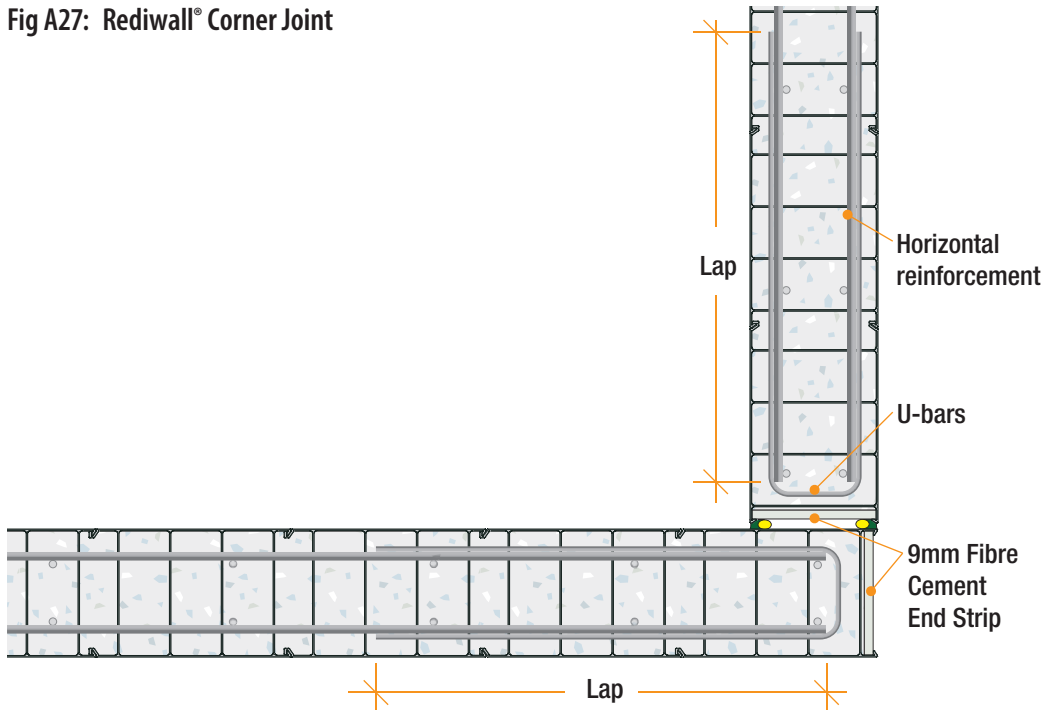
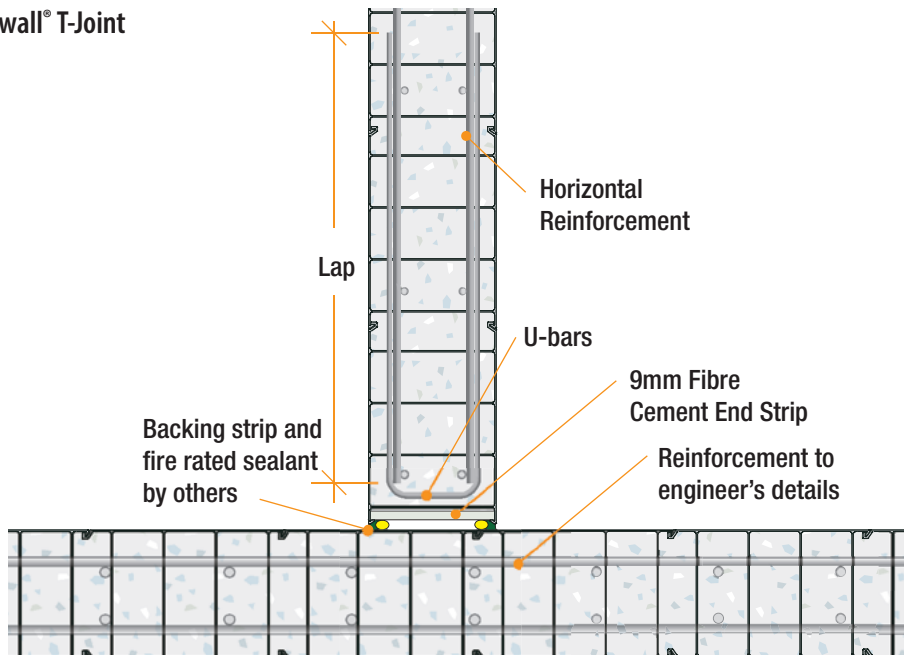

Fig A28: Rediwall® T-Joint



# AFS Rediwall® Blade Columns

## Introduction

AFS in conjunction with the Centre for Infrastructure Engineering, Western Sydney University (WSU) evaluated performance of AFS Rediwall® Blade Columns with simplified detailing utilising the standard U-bars instead of traditional closed ligatures or intermediate ties. The elimination of ties within the limitations detailed in this guide, simplifies design, detailing and installation of AFS Rediwall® Permanent Formwork systems. These methods can be used by the designer to significantly increase the speed of installation, improve construction flexibility and reduce construction costs while continuing to meet the compliance requirements of AS3600-2018 Amendment 2 and the NCC.

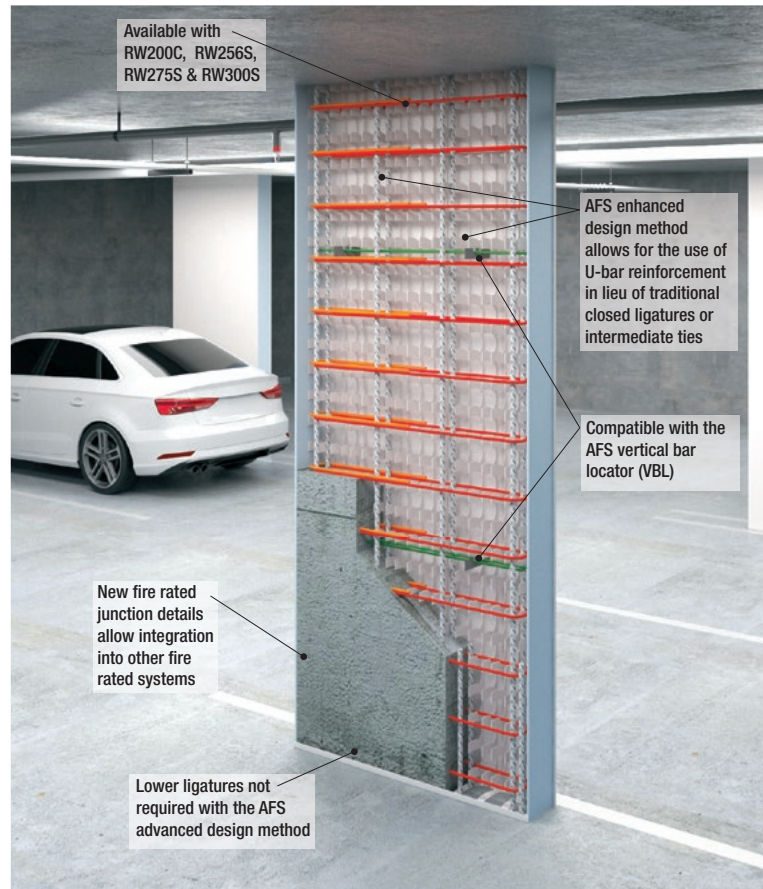

## Rediwall® RW200C FF Column Panel

The RW200C FF (Female-Female) Column Panel can be used to reverse the ends of a panel section. This is particularly useful during column construction when fibre cement end caps are required. Reversing the panel end results in a female end being present at both ends of the column, allowing for the installation of neat fibre cement end caps.

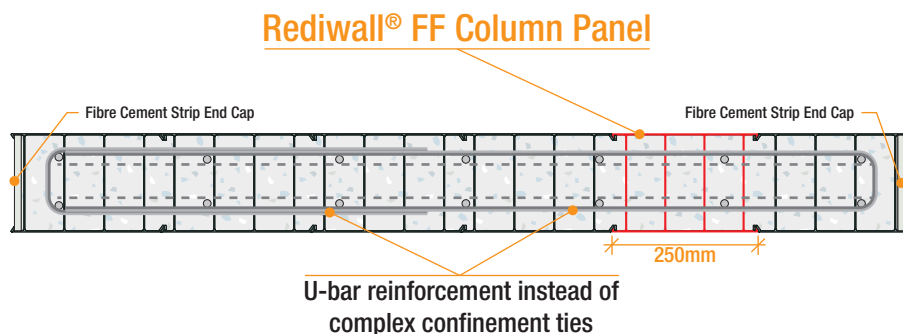

## Compliance and Verification

AFS Blade Column capacities have been load tested and verified by Western Sydney University using existing Deemed To Satisfy (DTS) and alternate performance design methods for the performance equivalence U-bars without ties to walls designed as columns with ties in accordance with the AS3600-2018 Strength check procedure for use with non-linear stress analysis.

check procedure for use with non-linear stress analysis using Advanced Finite Element non-linear stress analysis (ABAQUS) and comparative physical prototype testing to Appendix B3 Proof Testing of Members and Structures, to evaluate the structural performance of AFS Blade Columns with reduced reinforcing steel tie complexity under eccentric axial load.

The Advanced Design for AFS Blade Columns with end U-bars in-lieu of ligatures has been developed to AS3600-2018 clause 2.1.1 Design for strength and serviceability, in accordance with clause 2.2.6 Strength

Existing AS3600-2018 Design Methods and the new Advanced Design Methods are summarised in the following Design Flowchart:

FIG A29: Design flowchart

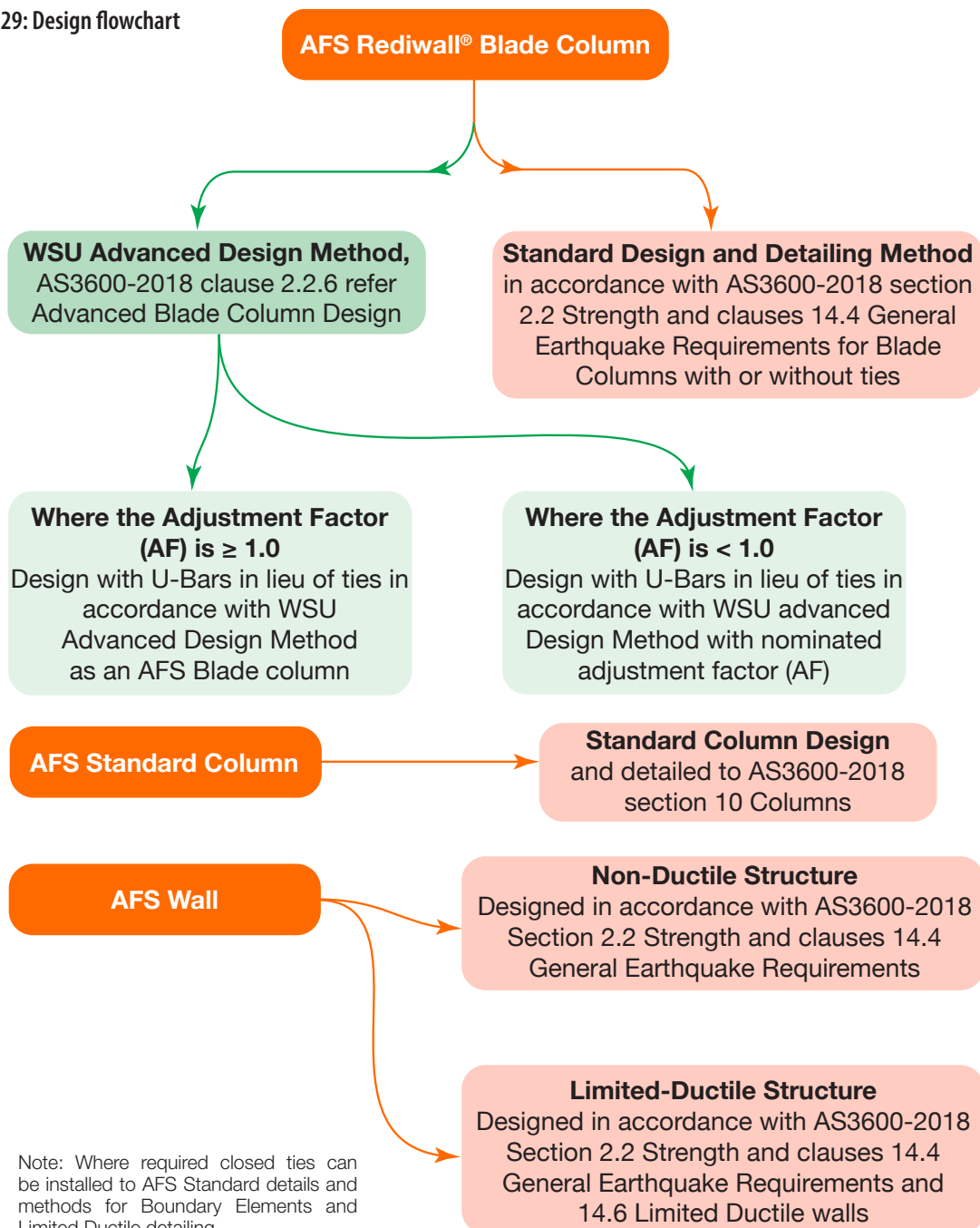

Note: Where required closed ties can be installed to AFS Standard details and methods for Boundary Elements and Limited Ductile detailing.

## AFS Rediwall® Advanced Blade Column Design

The AFS Rediwall® Advance Blade Columns design is in accordance with AS3600-2018 Section 10 provided the restraint provisions are satisfied within the provision of the WSU report<sup>[1]</sup> referring to clause 11.7.4 (a) & (b) Restraint of Vertical Reinforcement for Walls.

Detailing is as for walls designed as columns in accordance with AS3600-2018 clause 14.4.4 General Requirements, Structural Walls with the end U-bars replacing the closed ties.

### AS3600-2018 11.7.4 Restraint of Vertical Reinforcement

*In addition to providing transverse reinforcement required for any design actions, the following restraint to vertical reinforcement provisions shall be satisfied:*

- (a) *For all walls in structures with a structural ductility factor ( $\mu$ ) greater than 1.0, the vertical reinforcement shall be restrained in accordance with Clause 14.6*
- (b) *For walls with concrete strength not exceeding 50MPa and designed as columns in accordance with Section 10, the vertical reinforcement shall be restrained in accordance with Clause 10.7.4 unless one or more of the following conditions is met, in which case no restraint is required:*
- $N^* \leq 0.5 \phi N_p$*
  - The vertical reinforcement is not used as compressive reinforcement.*
  - The vertical reinforcement ratio is not greater than 0.01 and minimum horizontal reinforcement ratio or 0.0025 is provided.*

Non-Ductile AFS Rediwall Blade Columns can be designed to AS3600-2018 as Columns with U-bars in lieu of ties utilising the adjustment factor relevant to various design parameters according to the following WSU findings:

- For AFS-Rediwall detailed with end U-bars and no ligatures AS3600-2018 reference interaction diagram can be used utilising the adjustment factor relevant to various design parameters in the table below.

**TABLE A4: WSU adjustment factor table for afs rediwall®**

Concrete strength (MPa)	Vertical reinforcement ( $P_{vw}$ )	Wall Length ( $L_w$ )		
		$\leq 600$	$\leq 1500$	$\leq 2500$
Adjustment Factor				
32	< 0.5%	1.00	1.00	0.95
	0.5% to 1.0%	1.00	1.00	0.95
	1.0% to 2.2%	1.00	1.00	1.00
40	< 0.5%	1.00	1.00	0.95
	0.5% to 1.0%	1.00	0.95	0.90
	1.0% to 2.2%	1.00	1.00	1.00
50	< 0.5%	1.00	0.95	0.90
	0.5% to 1.0%	1.00	0.90	0.90
	1.0% to 2.2%	1.00	1.00	1.00

Note: for  $p > 1\%$  all compressive reinforcement was excluded for calculating interaction curves as per AS3600  
- Refer Figure 14 p52 WSU Report - for further details

- The moment magnifier technique of AS3600:2018 can conservatively be used to modify moment capacity for AFS encased columns for slenderness effects, (refer clause 6.5.3)
- Since the ratio of the larger to smaller cross-sectional dimension for the majority cases of afs rediwall® columns exceeds 3.0, biaxial bending and compression shall be satisfied as per clause 10.6.4 AS3600, (refer to Section 6.6)
- For afs rediwall® systems acting as part of seismic-lateral-bearing system with limited ductility criteria as per AS3600-2018 ( $\mu=2$  and  $s_p=0.77$ ), the additional checks for boundary element confinement using strength index method shall be conducted
- The report is for Non-Ductile Blade Column design only as section 14.6 Limited Ductile Design requirements were not included

Non-Ductile AFS Blade Columns can be designed in accordance with AS3600-2018 clause 14.2.2 for strength for the calculated horizontal drifts. In other words, for the vertical loads with an offset equaling the inter story drift which produces an additional bending moment along the major axis of the element.

## Design Examples

The following examples of AFS Blade Column solutions use the WSU AFS Advanced Blade Design methodology. Refer to the appropriate Blade Column Axial Capacity design table found in this document for detailed information.

**FIG A30: Typical Blade Column**

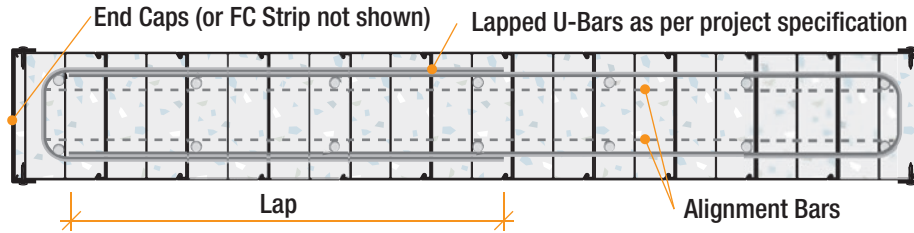

### Example 1 – For an RW200C Blade Column 1500 long

From RW200 Design Table  $\varnothing N_u = 1123 \text{ kN/m} \times 1500\text{mm} = 1684 \text{ kN}$

Values in tables were generated from standard moment interaction curves and moment magnifier loading. Check detailing against points 1 to 6 in 'WSU AFS Advanced Blade Design' section.

**FIG A31: Moment interaction chart: RW200C,  $H_{wu}=3000\text{mm}$ ,  $k=0.75$ ,  $50\text{MPa}$ ,  $2\text{N}20-200$  vert,  $\text{N}12-233$  horizontal U-bars each side**

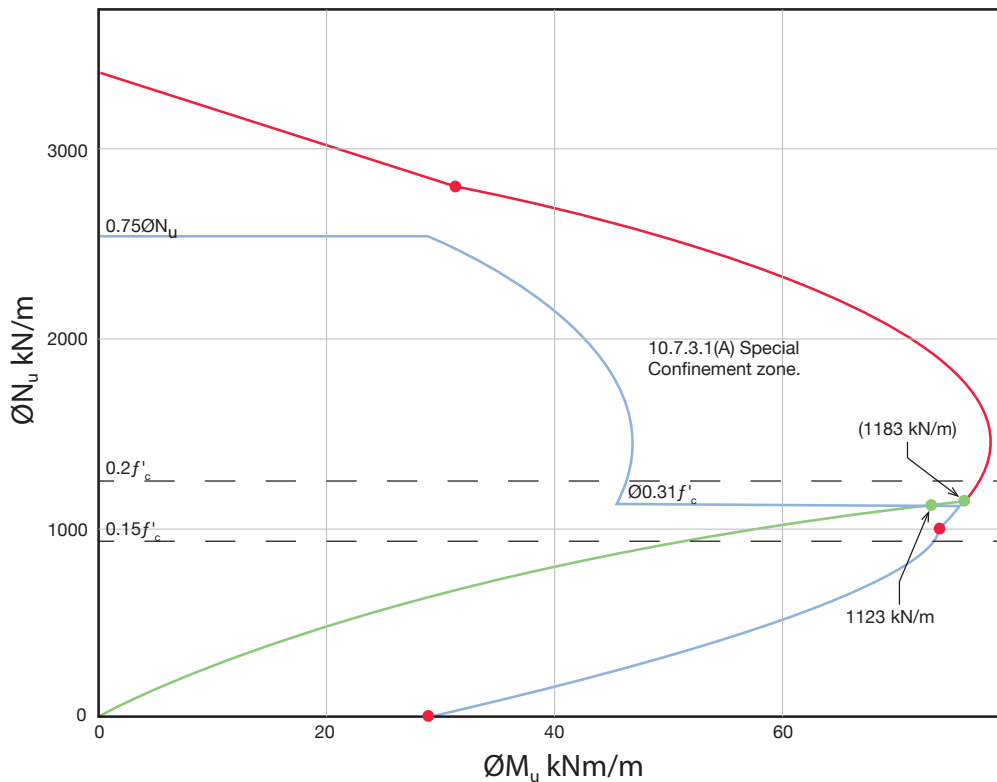

Note: AS3600-2018 14.6.2.3 Limited Ductile Structures of more than four storeys stress limits for longitudinal reinforcement restraint limits of  $0.2f_c$  and Boundary Elements requirement of  $0.15f_c$  have been shown for comparison.

**TABLE A5: FRP structural adequacy from AS3600-2018 clause 5.7.2**

RW200C FRP Structural Adequacy	90 minutes	120 minutes	180 minutes
RW200, exposed one side, built in to fire separating wall	$u_{fi} = 0.7$	$u_{fi} = 0.7$	$u_{fi} = 0.53$
RW200 x:y > 4, exposed two sides not built into fire separating walls	$u_{fi} = 0.7$	$u_{fi} = 0.62$	$u_{fi} = 0.31$

•  $a_s = 55\text{mm}$  ( $d_h = 41 + (N16 + N12)/2$ ),  $D = 195\text{mm}$ ,  $H_{we} < 7800$ ,  $u_{fi} = N^*_f / \varnothing N_u$

## Example 2 – For an RW300S Blade Column 2500 long

From RW300 Design Table  $\phi N_u = 1889 \text{ kN/m} \times 2500\text{mm} = 4722 \text{ kN}$

Values in tables were generated from standard moment interaction curves and moment magnifier loading. Check detailing against points 1 to 6 in 'WSU AFS Advanced Blade Design' section.

**FIG A32: Moment interaction chart: RW300S x2500long,  $H_{wu}=3000\text{mm}$ ,  $k=0.75$ , 32MPa, 2N16-300 vert, N12-233 horizontal U-bars each end**

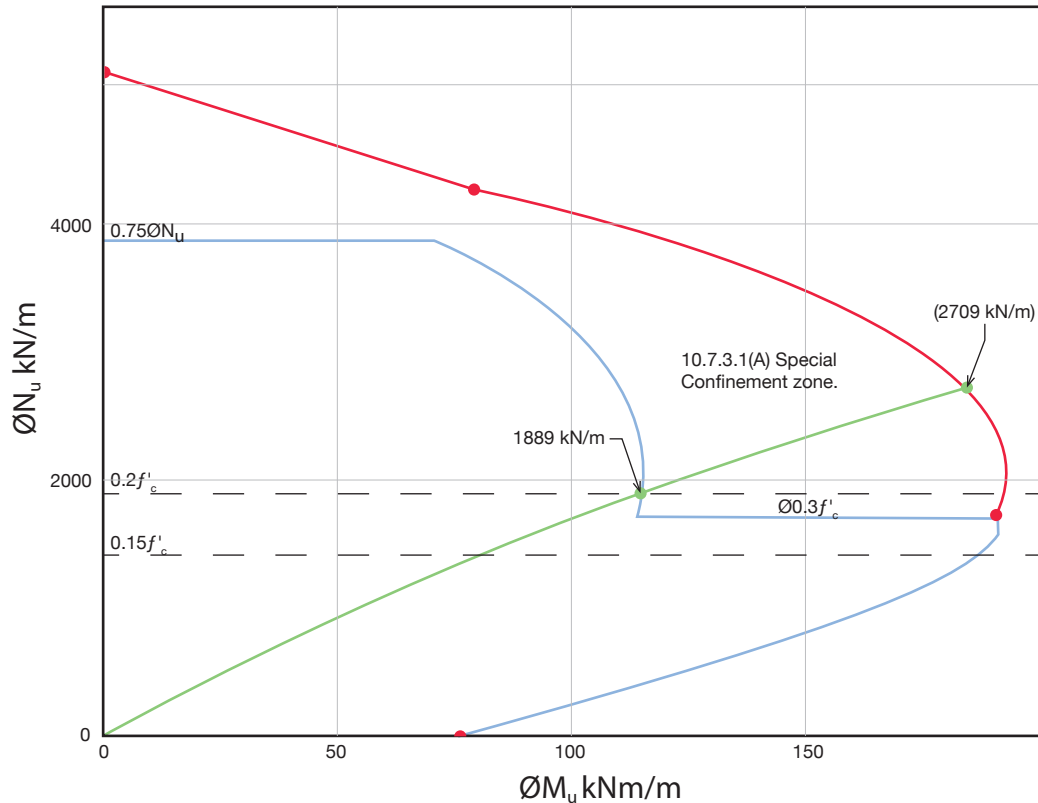

Note: AS3600-2018 14.6.2.3 Limited Ductile Structures of more than four storeys stress limits for longitudinal reinforcement restraint limits of  $0.2f'_c$  and Boundary Elements requirement of  $0.15f'_c$  have been shown for comparison.

**TABLE A6: FRP structural adequacy from AS3600-2018 clause 5.7.2**

RW300S FRP Structural Adequacy	90 minutes	120 minutes	180 minutes	240 minutes
Built into fire separating wall, exposed one side,	$u_{fi} = 0.7$	$u_{fi} = 0.7$	$u_{fi} = 0.7$	$u_{fi} = 0.7$
Isolated Blade, $x:y > 4$ , $B > 1200$ , exposed two sides	$u_{fi} = 0.7$	$u_{fi} = 0.7$	$u_{fi} = 0.7$	$u_{fi} = 0.54$
Isolated Blade, $x:y < 4$ , $B < 1200$ , exposed four sides, [Eq 5.6.3(2)]	$u_{fi} = 0.7$	$u_{fi} = 0.5$	$u_{fi} = 0.15$	–

•  $a_s = 55\text{mm}$  ( $d_h = 41 + (N16 + N12)/2$ ),  $D = 295\text{mm}$ ,  $H_{we} < 7800$ ,  $u_{fi} = N^* f / \phi N_u$

## AFS Rediwall® Advanced Column Design Tables

The following afs rediwall® design tables have been prepared utilising moment interaction curves and moment magnifier in accordance with the Advanced Design Methods to determine the member capacities for non-ductile vertical load bearing Blade Columns. Other column design tools can also be used provided

they account for the adopted clause 11.7.4(b) where for vertical reinforcement ratios exceed 0.01 the vertical reinforcement is not used as compression reinforcement and concrete strength does not exceed 50MPa.

## RW200C Blade Column Structural Capacity

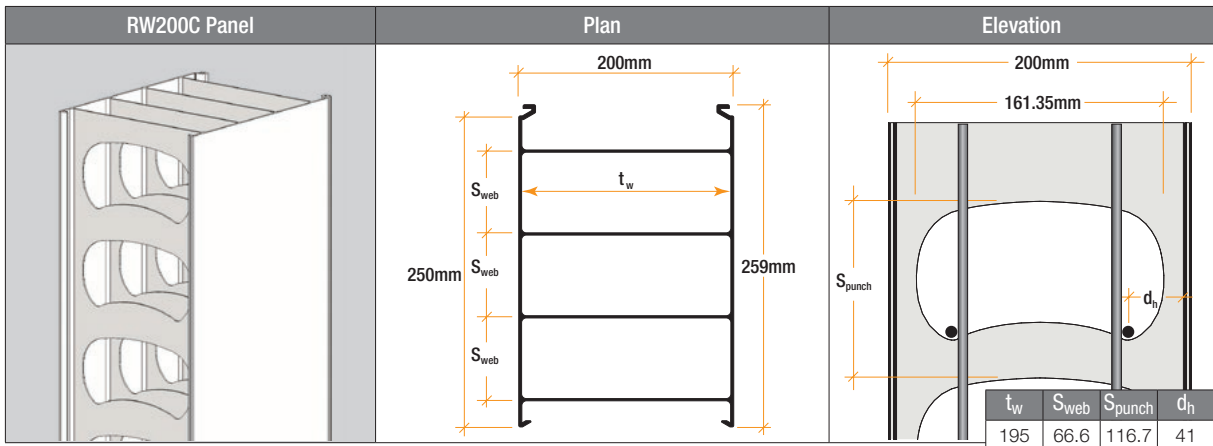
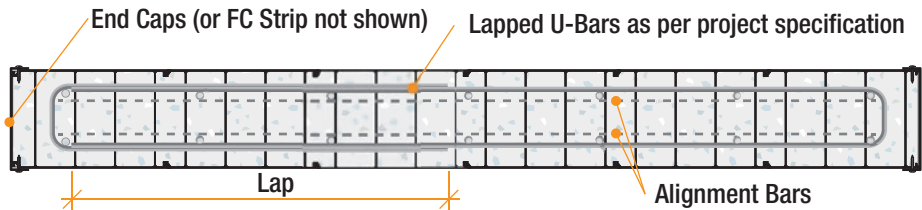

FIG A33: RW200C typical Blade Column



### RW200C Blade Column Axial Capacity $\phi N_u$ (kN/m) Non-Ductile 2 Layers

AFS Rediwall® Axial Loaded Blade Columns with U-bars in lieu of ties in accordance with 'AFS Logicwall® and AFS Rediwall® axial-flexural interaction curve generation numerical and theoretical investigations', Western Sydney University and AS3600-2018 Amdt 2 clause 11.7.4(b) Restraint.

		$\phi N_u$ (kN/m), Vertical Bars, $f'_c$ 32 Mpa			$\phi N_u$ (kN/m), Vertical Bars, $f'_c$ 40 Mpa			$\phi N_u$ (kN/m), Vertical Bars, $f'_c$ 50 Mpa		
ecc < 1/6	Hwu(k=1.0)	2N12-300	2N20-300	2N20-200	2N12-300	2N20-300	2N20-200	2N12-300	2N20-300	2N20-200
Hwu(k=0.75)	Hwe	0.0039	0.0107#1	0.0161#1	0.0039	0.0107#1	0.0161#1	0.0039	0.0107#1	0.0107#1
5500	4125	486	537	579	575	629	680	679	734	792
5000	3750	567	622	668	672	732	783	794	856	918
4500	3375	670	722	777	795	855	911	940	1006	1066
4000	3000	798	847	907	950	1003	1068	1127	1182	1252
3600	2700	921	967	1030	1100	1148	1217	1309	1357	1431
3200	2400	1062	1106	1123	1271	1319	1387	1516	1565	1639
3000	2250	1123	1123 (1183)	1123 (1243)	1372	1404	1404 (1480)	1640	1681	1754
2800	2100	1123 (1233)	1123 (1263)	1123 (1321)	1404 (1482)	1404 (1513)	1404 (1577)	1755 (1805)	1755 (1805)	1755 (1876)
0.15f'c Lateral limit		936			1170			1463		
Max Blade Length#2		1500 (0.5 to 1.0%)	2500 (1.0 to 2.2%)		600 (0.5 to 1.0%)	2500 (1.0 to 2.2%)		600 (0.5 to 1.0%)	2500 (1.0 to 2.2%)	

Number in brackets designates lower value where clause 10.7.3.1(2) applies.

#1 Compression reinforcement ignored in accordance with clause 11.7.4(b)

#2 Max Blade Length from WSU Report Fig 16 for Standard AFS detailed Blades with U-bars and no ties with Adjustment Factor to AS3600-2018  $\geq$  1.0

#3 Clause 14.6.2 Boundary Element limit if acting as part of Lateral System, refer WSU Report p4 Note 6

### RW200C Minimum Reinforcement

RW200C	Vertical Bars - Each Face			
Allowable Bars	N12	N16	N20	N24
N12 Horizontal	Acceptable	Acceptable	Acceptable	With Caution
N16 Horizontal	Not Recommended	Not Recommended	Not Recommended	Not Recommended

Horizontal Bar Spacing 233/350
Vertical Bar Spacing 150 to 350
Acceptable
With Caution
Not Recommended



## RW256S Blade Column Structural Capacity

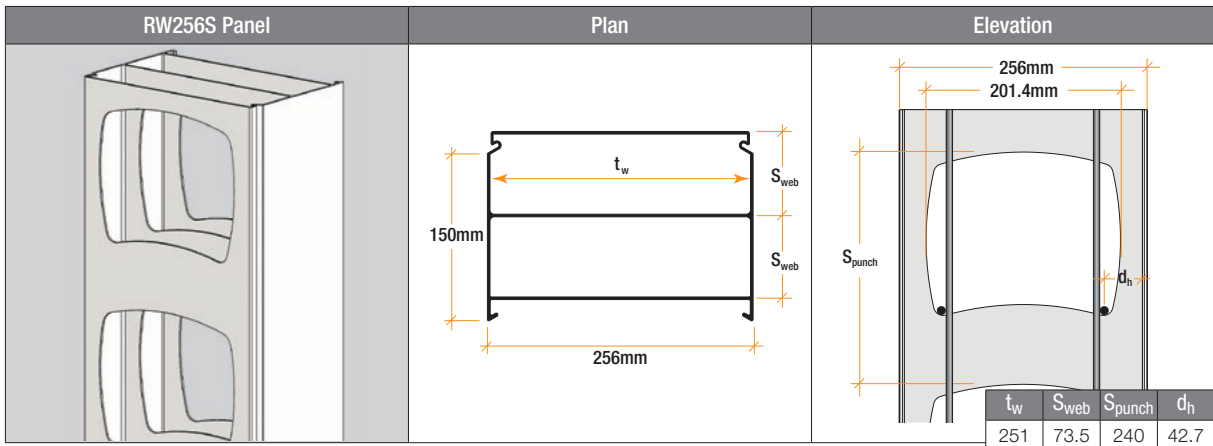
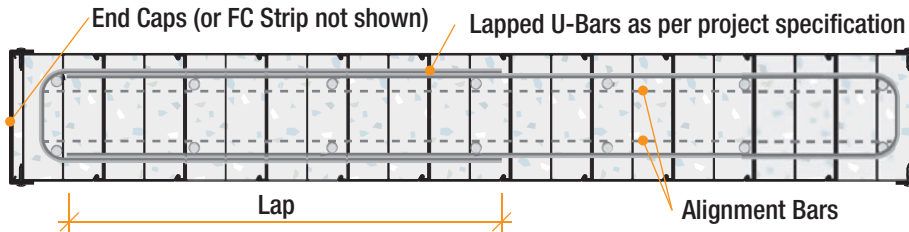

FIG A34: RW256S typical Blade Column



### RW256S Blade Column Axial Capacity $\phi N_u$ (kN/m) Non-Ductile 2 Layers

AFS Rediwall® Axial Loaded Blade Columns with U-bars in lieu of ties in accordance with 'AFS Logicwall® and AFS Rediwall® axial-flexural interaction curve generation numerical and theoretical investigations', Western Sydney University and AS3600-2018 Amdt 2 clause 11.7.4(b) Restraint.

ecc < 1/6	$H_{wu}(k=1.0)$	$\phi N_u$ (kN/m), Vertical Bars, $f'_c$ 32 Mpa			$\phi N_u$ (kN/m), Vertical Bars, $f'_c$ 40 Mpa			$\phi N_u$ (kN/m), Vertical Bars, $f'_c$ 50 Mpa		
		2N12-300	2N20-300	2N24-200	2N12-300	2N20-300	2N24-200	2N12-300	2N20-300	2N24-200
$H_{wu}(k=0.75)$	$H_{we}$	0.0030	0.0084	0.0107#1	0.0030	0.0084	0.0107#1	0.0030	0.0084	0.0107#1
5500	4125	1011	1182	1239	1202	1378	1449	1425	1604	1689
5000	3750	1162	1334	1386	1384	1562	1627	1644	1826	1903
4500	3375	1332	1440 (1515)	1440 (1548)	1592	1775	1800	1895	2079	2145
4000	3000	1440 (1518)	1440 (1720)	1440 (1721)	1800	1800 (2024)	1800 (2042)	2172	2250 (2378)	2250 (2413)
3600	2700	1440 (1693)	1440 (1900)	1440 (1862)	1800 (2034)	1800 (2243)	1800 (2223)	2250 (2437)	2250 (2645)	2250 (2641)
3200	2400	1440 (1878)	1505 (2086)	1504 (2001)	1800 (2263)	1800 (2473)	1800 (2403)	2250 (2721)	2250 (2929)	2250 (2872)
3000	2250	1440 (1970)	1559 (2179)	1546 (2068)	1800 (2379)	1832 (2588)	1844 (2490)	2250 (2865)	2250 (3072)	2250 (2986)
2800	2100	1440 (2062)	1614 (2270)	1587 (2131)	1800 (2493)	1899 (2702)	1897 (2574)	2250 (3007)	2250 (3213)	2255 (3096)
0.15 $f'_c$ Lateral limit#3		1200			1500			1875		
Max Blade Length#2		1500 (0.5 to 1.0%)	2500 (1.0 to 2.2%)		600 (0.5 to 1.0%)	2500 (1.0 to 2.2%)		600 (0.5 to 1.0%)	2500 (1.0 to 2.2%)	

Number in brackets designates lower value where clause 10.7.3.1(2) applies.

#1 Compression reinforcement ignored in accordance with clause 11.7.4(b)

#2 Max Blade Length from WSU Report Fig 16 for Standard AFS detailed Blades with U-bars and no ties with Adjustment Factor to AS3600-2018  $\geq 1.0$

#3 Clause 14.6.2 Boundary Element limit if acting as part of Lateral System, refer WSU Report p4 Note 6

### RW256S Minimum Reinforcement

RW256C	Vertical Bars - Each Face			
Allowable Bars	N12	N16	N20	N24
N12 Horizontal				
N16 Horizontal				

Horizontal Bar Spacing 240
Vertical Bar Spacing 150 to 350
Acceptable
With Caution
Not Recommended

## RW275S Blade Column Structural Capacity

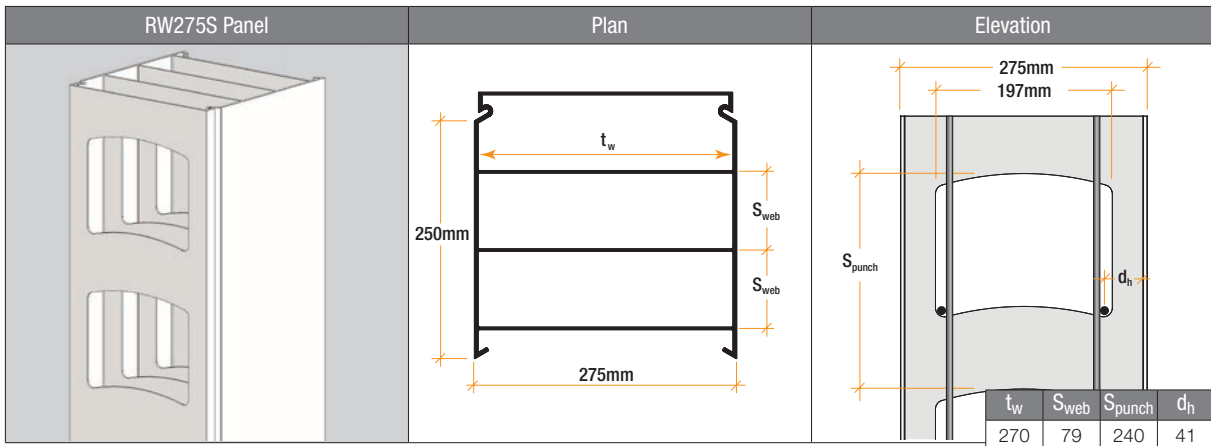
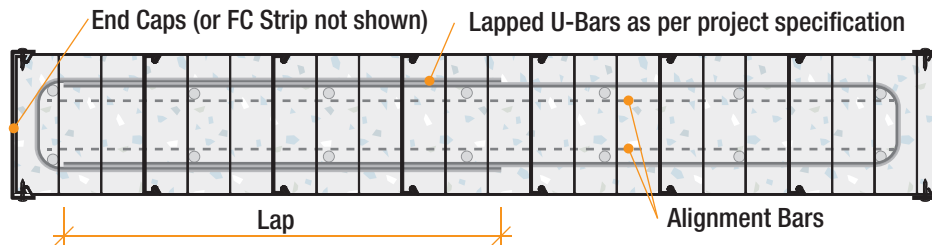

FIG A35: RW275S typical Blade Column



### RW275S Blade Column Axial Capacity $\phi N_u$ (kN/m) Non-Ductile 2 Layers

AFS Rediwall® Axial Loaded Blade Columns with U-bars in lieu of ties in accordance with 'AFS Logicwall® and AFS Rediwall® axial-flexural interaction curve generation numerical and theoretical investigations', Western Sydney University and AS3600-2018 Amdt 2 clause 11.7.4(b) Restraint.

ecc < 1/6	$H_{wu}(k=1.0)$	$\phi N_u$ (kN/m), Vertical Bars, $f'_c$ 32 Mpa			$\phi N_u$ (kN/m), Vertical Bars, $f'_c$ 40 Mpa			$\phi N_u$ (kN/m), Vertical Bars, $f'_c$ 50 Mpa		
		2N16-300	2N20-300	2N24-200	2N12-300	2N20-300	2N24-200	2N12-300	2N20-300	2N24-200
$H_{wu}(k=0.75)$	$H_{we}$	0.005	0.0078	0.0107#1	0.0028	0.0078	0.0107#1	0.0028	0.0078	0.0107#1
5500	4125	1333	1431	1480	1571	1675	1737	1848	1955	2032
5000	3750	1498	1549 (1605)	1549 (1639)	1774	1880	1931	2094	2199	2268
4500	3375	1549 (1687)	1549 (1804)	1549 (1809)	1937 (2000)	1937 (2119)	1937 (2143)	2366	2421 (2487)	2421 (2529)
4000	3000	1549 (1901)	1549 (2023)	1549 (1984)	1937 (2262)	1937 (2385)	1937 (2365)	2421 (2687)	2421 (2811)	2421 (2808)
3600	2700	1549 (2083)	1601 (2206)	1603 (2122)	1937 (2486)	1937 (2611)	1937 (2544)	2421 (2963)	2421 (3088)	2421 (3037)
3200	2400	1591 (2265)	1710 (2388)	1688 (2254)	1937 (2713)	2008 (2838)	2014 (2717)	2421 (3245)	2421 (3370)	2421 (3261)
3000	2250	1645 (2353)	1764 (2476)	1728 (2317)	1949 (2823)	2075 (2948)	2066 (2799)	2421 (3383)	2437 (3507)	2456 (3368)
2800	2100	1698 (2438)	1817 (2561)	1768 (2375)	2014 (2930)	2140 (3054)	2117 (2878)	2421 (3516)	2518 (3640)	2521 (3471)
0.15 $f'_c$ Lateral limit#3		1291			1614			2018		
Max Blade Length#2		1500 (0.5 to 1.0%)	2500 (1.0 to 2.2%)		600 (0.5 to 1.0%)	2500 (1.0 to 2.2%)		600 (0.5 to 1.0%)	2500 (1.0 to 2.2%)	

Number in brackets designates lower value where clause 10.7.3.1(2) applies.

#1 Compression reinforcement ignored in accordance with clause 11.7.4(b)

#2 Max Blade Length from WSU Report Fig 16 for Standard AFS detailed Blades with U-bars and no ties with Adjustment Factor to AS3600-2018  $\geq 1.0$

#3 Clause 14.6.2 Boundary Element limit if acting as part of Lateral System, refer WSU Report p4 Note 6

### RW275S Minimum Reinforcement

RW275S	Vertical Bars - Each Face				
Allowable Bars	N12	N16	N20	N24	N28
N12 Horizontal					
N16 Horizontal					

Horizontal Bar Spacing 240	Acceptable	
Vertical Bar Spacing 150 to 350		With Caution
		Not Recommended

## RW300S Blade Column Structural Capacity

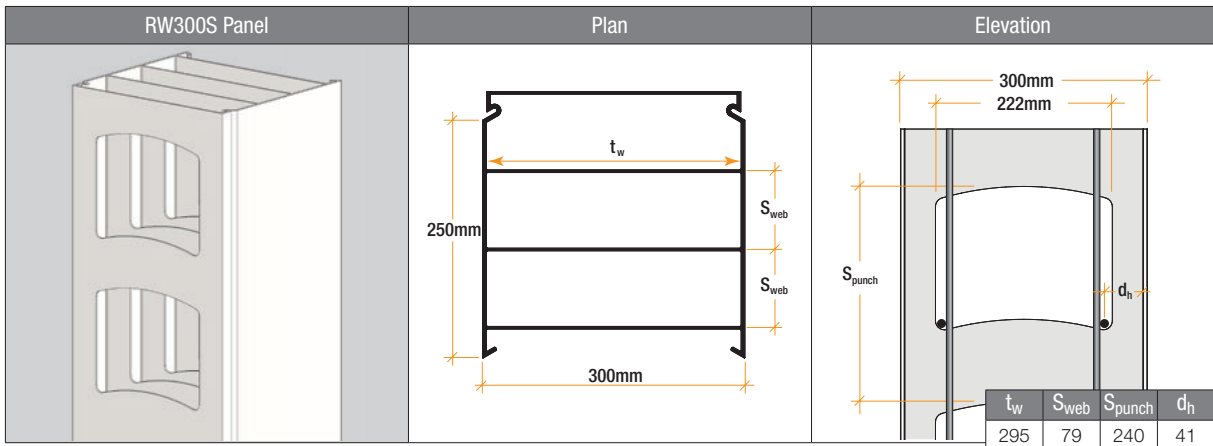
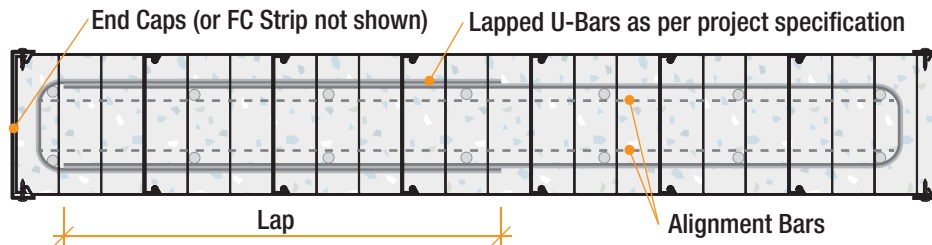

FIG A36: RW300S typical Blade Column



### RW300S Blade Column Axial Capacity $\phi N_u$ (kN/m) Non-Ductile 2 Layers

AFS Rediwall® Axial Loaded Blade Columns with U-bars in lieu of ties in accordance with 'AFS Logicwall® and AFS Rediwall® axial-flexural interaction curve generation numerical and theoretical investigations', Western Sydney University and AS3600-2018 Amdt 2 clause 11.7.4(b) Restraint.

ecc < 1/6	$H_{wu}(k=1.0)$	$\phi N_u$ (kN/m), Vertical Bars, $f'_c$ 32 Mpa			$\phi N_u$ (kN/m), Vertical Bars, $f'_c$ 40 Mpa			$\phi N_u$ (kN/m), Vertical Bars, $f'_c$ 50 Mpa		
		2N16-300	2N20-300	2N24-200	2N16-300	2N20-300	2N24-200	2N16-300	2N20-300	2N24-200
$H_{wu}(k=0.75)$	$H_{we}$	0.0046	0.0071	0.0107#1	0.0046	0.0071	0.0107#1	0.0046	0.0071	0.0107#1
5500	4125	1659	1693 (1779)	1693 (1807)	1963	2083	2117	2318	2437	2504
5000	3750	1693 (1843)	1693 (1976)	1693 (1976)	2117 (2185)	2117 (2321)	2117 (2341)	2585	2646 (2723)	2646 (2763)
4500	3375	1693 (2053)	1693 (2191)	1693 (2150)	2117 (2442)	2117 (2582)	2117 (2561)	2646 (2899)	2646 (3041)	2646 (3039)
4000	3000	1693 (2276)	1758 (2416)	1758 (2322)	2117 (2717)	2117 (2859)	2117 (2783)	2646 (3239)	2646 (3382)	2646 (3322)
3600	2700	1731 (2456)	1866 (2595)	1842 (2454)	2117 (2941)	2189 (3082)	2196 (2955)	2646 (3516)	2646 (3658)	2646 (3544)
3200	2400	1837 (2628)	1972 (2766)	1923 (2575)	2177 (3156)	2320 (3296)	2300 (3116)	2646 (3785)	2727 (3926)	2736 (3754)
3000	2250	1889 (2709)	2024 (2846)	1961 (2632)	2241 (3258)	2385 (3397)	2350 (3191)	2656 (3913)	2807 (4052)	2800 (3853)
2800	2100	1939 (2785)	2075 (2922)	1998 (2685)	2305 (3354)	2448 (3492)	2398 (3261)	2735 (4034)	2885 (4172)	2862 (3945)
0.15 $f'_c$ Lateral limit#3		1411.2			1764			2205		
Max Blade Length#2		1500 (0.5 to 1.0%)	2500 (1.0 to 2.2%)		600 (0.5 to 1.0%)	2500 (1.0 to 2.2%)		600 (0.5 to 1.0%)	2500 (1.0 to 2.2%)	

Number in brackets designates lower value where clause 10.7.3.1(2) applies.

#1 Compression reinforcement ignored in accordance with clause 11.7.4(b)

#2 Max Blade Length from WSU Report Fig 16 for Standard AFS detailed Blades with U-bars and no ties with Adjustment Factor to AS3600-2018  $\geq 1.0$

#3 Clause 14.6.2 Boundary Element limit if acting as part of Lateral System, refer WSU Report p4 Note 6

### RW300S Minimum Reinforcement

RW300S	Vertical Bars - Each Face (min. N12-350)				
Allowable Bars	N12	N16	N20	N24	N28
N12 Horizontal					
N16 Horizontal					

Horizontal Bar Spacing 240
Vertical Bar Spacing 150 to 350
Acceptable
With Caution
Not Recommended

## Fire Performance

### AFS Rediwall® Fire Performance

AFS Rediwall® has been fire tested and assessed. Stephen Grubits & Associates (SGA) have analysed the fire-resistance of afs rediwall® to be in accordance with AS 3600-2018 allowing the FRP of afs rediwall® to be determined for structural adequacy, integrity and insulation.

For more details, refer to the SGA report 2013/277.26 R.1.1 Issued 9/9/2019 'Fire-Resistance of Rediwall® – Determination in accordance with AS 3600'[3].

### Fire Rated Junctions

A range of fire junction solutions have been fire tested and assessed to AS1530.4-2014 for the easy integration of various fire rated system and Rediwall®.

The junction details include options to connect afs rediwall® with pvc face left in place, to:

- CSR Gyprock Fyrchek
- CSR Gyprock Shaft Liner Panel
- CSR Hebel
- Concrete and concrete masonry wall systems

For a additional information refer to afs rediwall® Fire Rated Junction Guide or contact AFS Technical Support.

FIG A37: Example of a fire rated junction

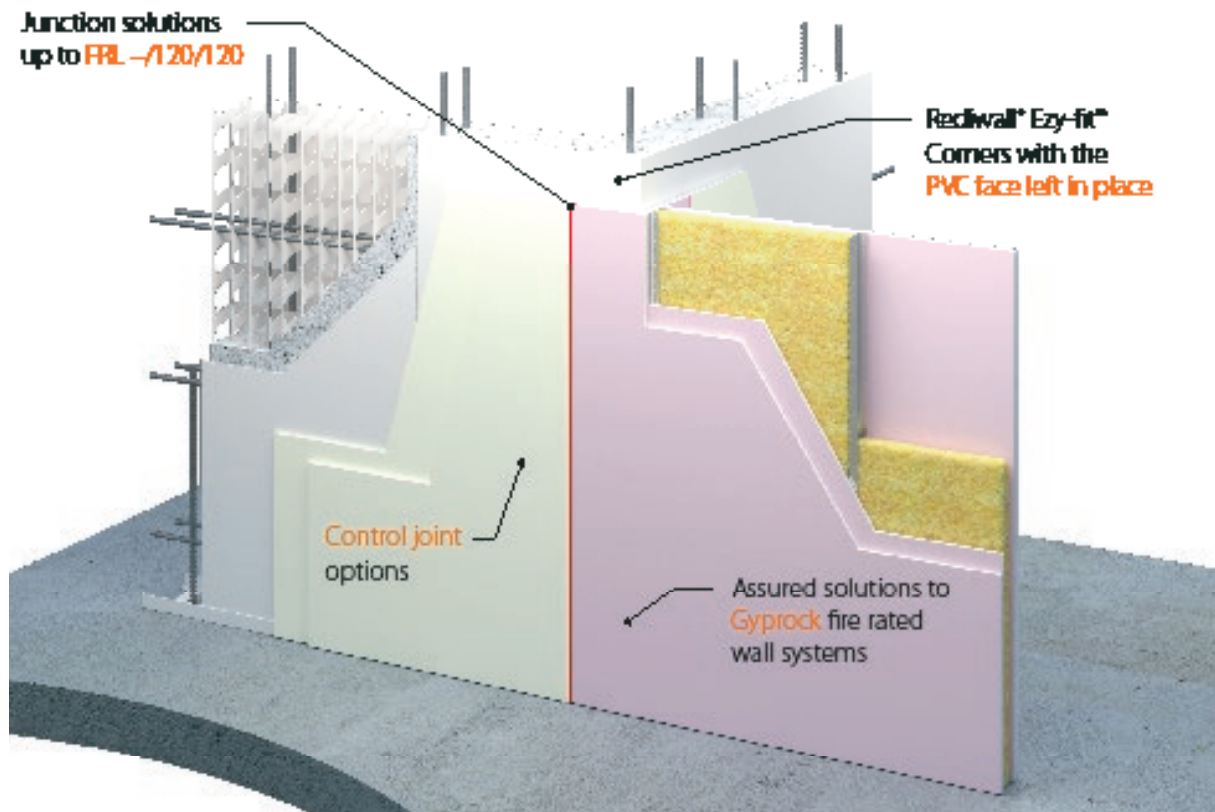

# Core Filling of Walls

## Introduction

AFS Rediwall® is to be filled with AFS special concrete mix. The concrete mix and concrete placement technique is critical to the successful outcome of filling rediwall®.

AFS has carried out tests which achieved desired compaction and dense, homogeneous coverage of afs rediwall®.

This guide sets out the methods used by AFS to achieve suitable compaction.

The contractor or installer is responsible for achieving compaction and dense, homogeneous coverage of the concrete mix in Rediwall®. AFS accepts no responsibility for achieving compaction of the concrete in afs rediwall® or core filling of walls.

## Concrete Mix Design

The following afs concrete mix guide shall be used together with concrete placement in accordance with Volume 3 – 'rediwall® Installation Guide' to achieve the requirements of AS3600 – 2018. Reputable concrete suppliers have standard mix designs to achieve these requirements.

## Rediwall® Concrete Mix Design Guide

	AFS Rediwall® (Refer to Structural Engineer for Mix specification)				
	S25	S32	S40	S50	S65
Strength $f'c$ (MPa)	S25	S32	S40	S50	S65
Target Installation Slump	180±20	180±20	180±20	180±20	180±20
Design Slump (mm)	180	180	180	180	180
Maximum W/C Ratio	0.7	0.6	0.45	0.4	0.35
Nominal Fine to Total Aggregate Percentage (%)	65	60	55	50	50
Maximum Aggregate Size (mm)	10	10	10	10	10
Maximum 56 Day Drying Shrinkage (µm)	1000	1000	1000	1000	1000
Recommended Admixtures	WRPAPN20 (WR) ex Grace, ADVA-142 (HWR) ex Grace, or equivalent				

Notes:

- For higher on-site temperature environments slump at the batching plant may be varied to suit these conditions.
- Site water is allowed to be used to reach desired installation slump however, the maximum W/C ratio must not be exceeded.
- Due to local raw material availability, characteristics will vary significantly, refer to Project Engineer for further details.
- The addition of all admixtures are typically dosed at the beginning of the batch.
- Concrete mix should have a typical 'Gel' time of 30-60min in accordance with the Gel Test detailed in this guide.

# Self Compacting Concrete

## AFS Approved SCC Mix

The concrete supplier is responsible for providing a Self Compacting Concrete (SCC) Mix design that satisfies the performance requirements of the Building specification, AS3600-2018 and Rediwall concrete specification. The mixing and design for SCC is critical for its performance to prevent segregation while allow adequate time for pumping and placement prior to consolidation without requiring vibration.

AFS trials and experience have shown that a SCC mix that is designed such that segregation and blowouts are prevented whilst achieving the required level of compaction will have the following characteristics:

- $f'c = 32$  to 50 MPa, as specified in project documentation
- SCC Spread 500 to 700 mm
- 7-14 mm maximum aggregate
- Long line or pumpable wall mix
- Segregation and consolidation

Small scale trials should be undertaken to confirm performance of any proposed SCC mix prior to approval. Trial to consist of:

- Supplier and plant to have previous experience with SCC mix
- Minimum 3 metre high short wall panel
- Panel to be filled in accordance with this guide
- Braced plain plastic end caps to be used to allow stripping
- End caps to be stripped and inspected for:
  - Segregation
  - Honeycombing
  - Voids.
  - Surface should be relatively uniform with minimal defects.

AFS has undertaken these trials for the following approved SCC suppliers:

- For Sydney Metro Area - Order: (32/40/50) MPa Algiria SCC, 10mm aggregate, Spread 650mm

## Pre-Construction

Panels and accessories to be inspected and any damaged or distorted items to be discarded. Gaps or mismatch may result in leaks or failures.

It is important to arrange concrete supply allowing for 90 minute discharge and 15 minute hold limit on site. Each truck should be discharged continuously with minimum of holds. If a leak is observed hold pour until rectified.

For pump clean our It is recommend having material for, bulk cleanout bags or other arrangements.

## Wall Detailing

Details have been trialled to suit the pressures of SCC concrete and are to be used in place of the similar standard details

## Construction

It is recommended that this guide be read to ensure correct installation of rediwall®. Preparation, layout and construction are similar to normal concrete with extra care and detailing at joints and junctions. Good planning is important to ensure that core filling occurs with minimal holds.

AFS Rediwall® should be fully braced in accordance with the appropriate Design and Installation details. Due to the higher concrete pressures SCC can require additional bracing at some details beyond what is detailed in the rediwall® Design and Installation guide. Additional examples of SCC bracing have been provided in this guide. Consultation with the site engineer should occur before pouring commences.

## Concrete placement

- Walls up to 3 metres high can be filled in 2 passes/lifts with the first pass being to a maximum height of 1.2 – 1.5m.
- Walls from 3 – 6m should be filled in 3 – 4 passes with the first and second pass being to a maximum height of 1m each.
- Allow at least 30 minutes between passes for higher walls to allow concrete to partially set.
- Prior to filling wall inspect all detailing for gaps or weaknesses. Ensure all bracing has been installed to AFS guidelines or Engineers requirements.
- SCC spread test is required for each batch. Reject concrete load if out of specification.
- Excessive Water is not to be used to wet up concrete. Maximum 10 litres per m3.
- Wall shall be filled from static locations, maximum 8 metres apart) allowing SCC to flow and fill the wall.
- Concrete filling should be landed onto wet concrete allowing the concrete to flow out filling the wall.
- Maximum drop from hose to concrete shall be 3 metres. Minimise drop distance were possible by lowering hose into wall.
- Concrete bonding agent to be sprayed on surface between lifts.
- Single fill will require additional bracing of junctions and details.

The Standard AFS Gel Test is not required for SCC and does not provide a useful measure of time between lifts. Follow procedures above for time between lifts.

Higher concrete strength mixes will gel faster than low strength mix designs. These guidelines will vary according to site conditions, with the requirement of extra passes and extra gelling time in wet/cold weather. In cases of extreme weather the concrete pour should be postponed.

FIG A38: Typical SCC flow

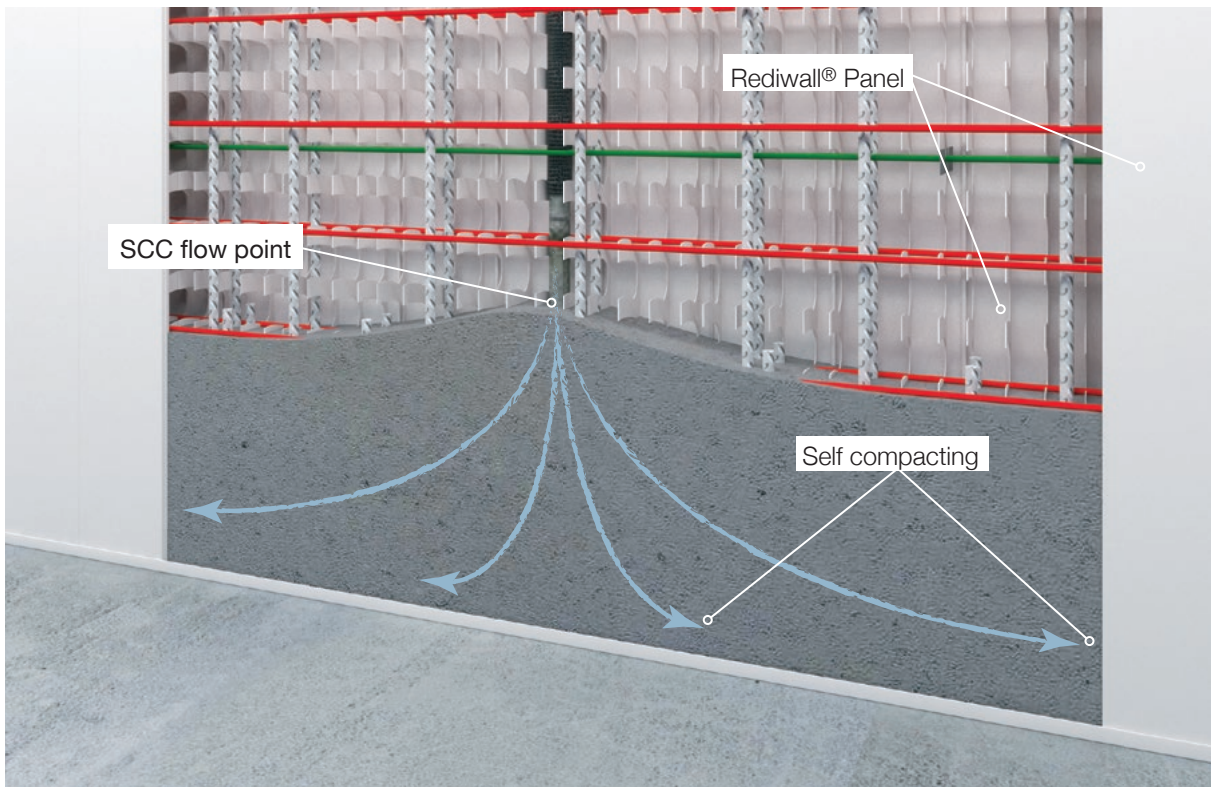

## Concrete Clean-up

During the pour, some concrete splatter may occur on the slab below and down the afs rediwall® panels.

All concrete splatter must be cleaned off before it cures.

Team members should follow the pour, brushing all splatter concrete off the slab and walls and if necessary, wiping the walls down with a wet sponge.

# Performance

---

The afs rediwall® system has Codemark Certification to confirm that it can be designed, detailed and installed to satisfy the relevant requirements of NCC 2022. These include the following:

## **Section C. Fire Resistance:**

- C1P1 (NCC2019 CP1) Structure stability
- C1P2 (NCC2019 CP2) Avoid spread of fire
- C1P3 (NCC2019 CP3) Protect from spread of fire and smoke in patient care and aged care buildings
- C1P4 (NCC2019 CP4) Safe conditions for evacuation
- C1P7 (NCC2019 CP7) Avoid spread of fire to emergency equipment
- C1P8 (NCC2019 CP8) Protect spread of fire to openings and penetrations

## **Section F. Health and Amenity**

- F3P1 (NCC2019 FP1.4) Weatherproofing
- F7P2 (NCC2019) Sound transmission through walls
- F7P4 (NCC2019 FP5.5) Sound transmission and insulation – Walls in age care buildings

## **Section G. Ancillary Provisions**

- G5P1 (NCC2019 GP5.1) Bush fire resistance

## **Sections J. Energy efficiency**

- J1P1 (NCC2019 JP1) Energy efficiency



## Fire Testing

AFS Rediwall® has had extensive fire testing and fire assessments to provide supportive evidence to back the Rediwall® fire and non-combustibility compliance. This includes:

- AS5113 (BS8414) Facade Fire Test
- AS5637.1 Reaction of Fire Classification (AS/ISO9705 Room Fire Test)
- AS1530.4 Fire Resistance Levels (FRL) Test/Assessment
- AS1530.4 FRL Penetration Test/Assessment
- AS1530.3 Fire Hazard Properties Test

## Fire Resistance Levels (FRL)s

Fire rating requirements of the NCC are specified in terms of Fire Resistance Levels (FRL). The FRL specifies the performance, in minutes, of the fire tested specimens for each of the following three design criteria when fire tested to the requirements of the Australian Standards AS1530 'Methods for Fire Test on Building Materials, Components and Structures' part 4 'Fire-Resistance Tests of Elements of Building Construction.

- Structural adequacy
- Integrity
- Insulation

A wall system under fire test that carries its load for 240 minutes and maintains its integrity and insulation for 240 minutes is given a FRL of 240/240/240, i.e 240 minutes structural adequacy, 240 minutes integrity and 240 minutes insulation.

Systems constructed to the standard required for particular FRL may be used to satisfy the requirements of lesser FRL.

Fire resistance levels of rediwall may be determined in accordance with NCC 2022 using the FRL given in the CSIRO Fire Test Reports. Where the wall characteristics are outside the limits of the CSIRO Fire Test Reports the FRL may be determined by the standard methods in AS3600–2018.

TABLE A7: FRL by CSIRO Fire Test

Type	$t_w$	$F'_c$	$H_w$ max	$N^*$ max	FRL
	(mm)	(MPa)	(mm)	(kN)	(Ade/Int/Ins)
RW110C	105	32***	2700	152	90/90/90**
RW156C	150	32***	3000	333	240/240/240*
RW200C	195	32***	3000	333	240/240/240*
RW256S	250	32***	3000	333	240/240/240*
RW275S	270	32***	3000	333	240/240/240*
RW300S	295	32***	3000	333	240/240/240*

\*FRL Determined by CSIRO Fire Test Report Number FCO3399

\*\*FRL Determined by SGA Report 2013/277.65 R1.6

\*\*\*S32 MPa afs concrete mix

TABLE A8: AS3600 Fire Resistance Period (FRP) Structural Adequacy<sup>^</sup> – Exposed 1 Side

Wall	$t_{w,fire}$	60 Minutes	90 Minutes	120 Minutes	180 Minutes	240 Minutes	FRP Insulation <sup>^^</sup>
		$N^*/\phi N_u$	$N^*/\phi N_u$	$N^*/\phi N_u$	$N^*/\phi N_u$	$N^*/\phi N_u$	Minutes
RW110C	105	0.26	0.09	–	–	–	90
RW156C	150	0.70	0.70	0.35	–	–	180
RW200C	195	0.70	0.70	0.70	0.53	–	240
RW256S	250	0.70	0.70	0.70	0.70	0.54	240
RW275S	269	0.70	0.70	0.70	0.70	0.69	240
RW300S	294	0.70	0.70	0.70	0.70	0.70	240

Acceptable  $N^*/\phi N_u = 0.7$       With Caution  $N^*/\phi N_u < 0.7$

<sup>^</sup> FRP Structural Adequacy based on AS3600 – 2018, Table 5.7.2

<sup>^^</sup> FRP Insulation based on CSIRO Test Report N° FCO3399

TABLE A9: AS3600 Fire Resistance Period FRP Structural Adequacy<sup>^</sup> – Exposed 2 Side

Wall	$t_{w,fire}$	60 Minutes	90 Minutes	120 Minutes	180 Minutes	240 Minutes	FRP Insulation <sup>^^</sup>
		$N^*/\phi N_u$	$N^*/\phi N_u$	$N^*/\phi N_u$	$N^*/\phi N_u$	$N^*/\phi N_u$	Minutes
RW110C	105	–	–	–	–	–	90
RW156C	150	0.70	0.50	0.20	–	–	180
RW200C	195	0.70	0.70	0.62	0.31	–	240
RW256S	250	0.70	0.70	0.70	0.60	0.35	240
RW275S	269	0.70	0.70	0.70	0.70	0.45	240
RW300S	294	0.70	0.70	0.70	0.70	0.54	240

Acceptable  $N^*/\phi N_u = 0.7$       With Caution  $N^*/\phi N_u < 0.7$

<sup>^</sup> FRP Structural Adequacy based on AS3600 – 2018, Table 5.7.2

<sup>^^</sup> FRP Insulation based on CSIRO Test Report N° FCO3399

## Non-Combustibility – Wall Applications & Finishes

Rediwall® is compliant with the relevant parts of the National Construction Code 2022 (NCC 2022) for use within various non-combustible wall applications internally and externally for Classes 1, 10, and Class 2-9 buildings.

The following summaries of rediwall® internal and external wall applications with associated finishes have been assessed by Stephen Grubits & Associates, Fire Safety Engineer's Report 2013/277.78 R1.6 to be compliant with the relevant fire resistance performance requirements in NCC 2022.

**TABLE A10: Summary of compliance with Performance Requirements & Essential Safety Precautions**

### Rediwall® as Internal Wall Applications<sup>1</sup>

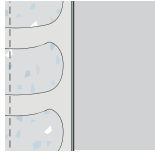
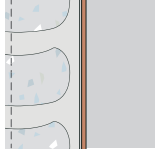
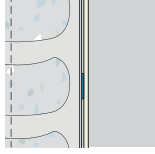
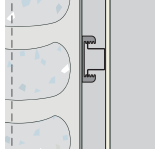
Applications	Compliance with NCC 2022 Performance Requirements	Finishes	Safety Measures
<b>Non-loadbearing fire resisting internal walls</b> (Assessment 1A)	PVC formwork is not considered to affect compliance with C1P2, C1P3 and C1P4 (NCC2019 CP2, CP3 & CP4)	a. Unclad and PVC lining left in place 	No additional measures are required as fire spread and development of untenable conditions due to PVC formwork as well as over-cladding has been determined to be unlikely
<b>Loadbearing fire resisting internal walls</b> (Assessment 1B)	PVC formwork is not considered to affect compliance with C1P1, C1P2, C1P3 and C1P4 (NCC2019 CP1, CP2, CP3 & CP4)		
<b>Non-loadbearing non-fire resisting internal walls</b> (Assessment 1C)	PVC formwork is not considered to affect compliance with C1P3 and C1P4 (NCC2019 CP3 & CP4)	b. Cement render or similar non-combustible render finish over unclad rediwall® 	
<b>Loadbearing non-fire resisting internal walls</b> (Assessment 1D)	PVC formwork is not considered to affect compliance with C1P3 and C1P4 (NCC2019 CP3 & CP4)		
<b>Separating walls in Class 1 buildings</b> (Assessment 1E)	PVC formwork is not considered to affect compliance with H3P1 (NCC2019 P2.3.1)	c. Plasterboard lining directly affixed to surface of unclad rediwall® 	
<b>Non-loadbearing fire walls</b> (Assessment 2A)	PVC formwork is not considered to affect compliance with C1P2, C1P3 and C1P4 (NCC2019 CP2, CP3 & CP4)		
<b>Loadbearing fire walls</b> (Assessment 2B)	PVC formwork is not considered to affect compliance with C1P1, C1P2, C1P3 and C1P4 (NCC2019 CP1, CP2, CP3 & CP4)	d. Plasterboard lining affixed to unclad rediwall®, using steel furring channels of specific orientation and spacing 	
Continued on next page...			

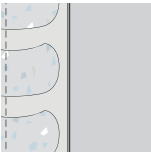
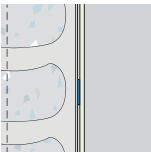
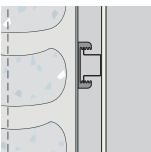
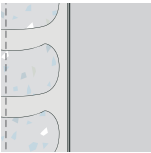
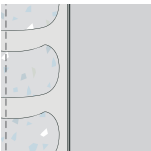
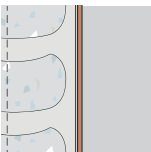
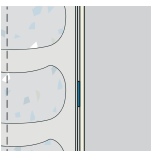
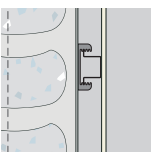
Applications	Compliance with NCC 2022 Performance Requirements	Finishes	Safety Measures
<p><b>Non-loadbearing fire walls</b> (Assessment 6A)</p>	<p>PVC formwork is not considered to affect compliance with C1P1, C1P2, and C1P7 (NCC2019 CP1, CP2, &amp; CP7)</p>	<p>a. Unclad and PVC lining left in place </p> <p>c. Plasterboard lining directly affixed to surface of unclad rediwall® </p> <p>d. Plasterboard lining affixed to unclad rediwall®, using steel furring channels of specific orientation and spacing </p>	<p>No additional measures are required as fire spread and development of untenable conditions due to PVC formwork as well as over-cladding has been determined to be unlikely</p>
<p><b>Internal lift shaft wall (internal face of the shaft wall)</b> (Assessment 7A)</p>	<p>PVC formwork is not considered to affect compliance with C1P1, C1P2, C1P3, C1P4 and C1P7 (NCC2019 CP1, CP2, CP3, CP4 &amp; CP7)</p>	<p>a. Unclad and PVC lining left in place </p>	<p>No additional measures are required as fire spread and development of untenable conditions due to PVC formwork has been determined to be unlikely</p>
<p><b>Internal walls in fire isolated exits</b> (Assessment 8A)</p>	<p>PVC formwork is not considered to affect compliance with C1P1, C1P2, C1P3, C1P4 and C1P7 (NCC2019 CP1, CP2, CP3, CP4 &amp; CP7)</p>	<p>a. Unclad and PVC lining left in place </p> <p>b. Cement render or similar non-combustible render finish over unclad rediwall® </p> <p>c. Plasterboard lining directly affixed to surface of unclad rediwall® </p> <p>d. Plasterboard lining affixed to unclad rediwall®, using steel furring channels of specific orientation and spacing </p>	<p>No additional measures are required as fire spread and development of untenable conditions due to PVC formwork as well as over-cladding has been determined to be unlikely</p>
<p>Continued on next page...</p>			

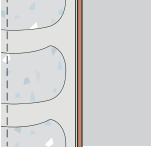
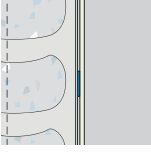
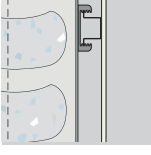
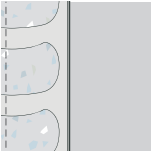

Applications	Compliance with NCC 2022 Performance Requirements	Finishes	Safety Measures
<p><b>Internal walls in fire-control rooms</b> (Assessment 9A)</p>	<p>PVC formwork is not considered to affect compliance with C1P1, C1P2, C1P3, C1P4 and C1P7 (NCC2019 CP1, CP2, CP3, CP4 &amp; CP7)</p>	<p>a. Unclad and PVC lining left in place </p> <p>b. Cement render or similar non-combustible render finish over unclad rediwall® </p> <p>c. Plasterboard lining directly affixed to surface of unclad rediwall® </p> <p>d. Plasterboard lining affixed to unclad rediwall®, using steel furring channels of specific orientation and spacing </p>	<p>No additional measures are required as fire spread and development of untenable conditions due to PVC formwork as well as over-cladding has been determined to be unlikely</p>
<p><b>Service penetrations in fire resisting walls</b> (Assessment 11A)</p>	<p>PVC formwork is not considered to affect compliance with C1P2 and C1P8 (NCC2019 CP2 &amp; CP8)</p>	<p>a. Unclad and PVC lining left in place </p>	<p>Penetration in unclad and PVC lining left in place rediwall®, the PVC skin on the panel face is not considered to affect compliance with C1P2 and C1P8. For fire dampers, 6mm FC sheet is to be fitted between wall face and damper frame extending 20mm beyond frame edge.</p>

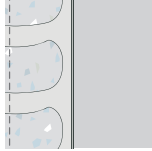
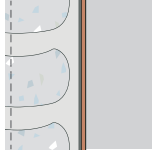
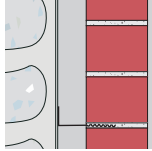
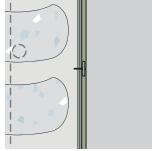
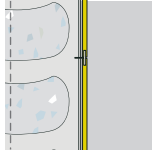
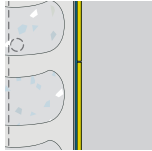
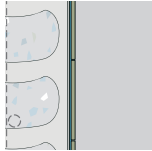

1. This table is based on the Stephen Grubits & Associates rediwall Codemark Certification report, 2013/277.78 R1.6

**TABLE A11: Summary of compliance with Performance Requirements & Essential Safety Precautions**  
**Rediwall® as External Wall Applications<sup>1</sup>**

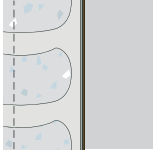
Applications	Compliance with NCC Performance Requirements	Finishes	Safety Measures
<b>Non-loadbearing fire resisting external walls</b> (Assessment 3A)	PVC formwork is not considered to affect compliance with C1P2 (NCC2019 CP2)	a. Unclad PVC lining left in place 	No additional measures are required as fire spread and development of untenable conditions due to PVC formwork as well as over-cladding has been determined to be unlikely, subject to the following:  – When applying finishes e, f or g, installation of an appropriate fire-stopping system <sup>3</sup> in the cavity is considered essential.
<b>Loadbearing fire resisting external walls/spandrels</b> (Assessment 3B)	PVC formwork is not considered to affect compliance with C1P1 and C1P2 (NCC2019 CP1 & CP2)	b. Non-combustible cement render or similar render finish over unclad Rediwall® 	
<b>Non-loadbearing non-fire resisting external walls</b> (Assessment 4A)	PVC formwork is not considered to affect compliance with C1P2 (NCC2019 CP2)	e. Face brick with inner rediwall® skin forming a cavity wall 	
<b>Loadbearing fire resisting external walls/spandrels</b> (Assessment 4B)	PVC formwork is not considered to affect compliance with C1P1 and C1P2 (NCC2019 CP1 & CP2)	f. Mechanically fixed tile system (<32kg/m <sup>2</sup> ) to unclad rediwall® 	
		g. Mechanically fixed non-combustible cladding to unclad rediwall® 	
<b>External walls above fire exits</b> (Assessment 5A)	PVC formwork is not considered to affect compliance with C1P1 and C1P2 (NCC2019 CP1 & CP2)	h. Direct-stick non-combustible cladding + adhesive to unclad rediwall®   i. Glue-fixed tile systems (<32kg/m <sup>2</sup> ) + adhesive to unclad rediwall® 	The following safety measures are required when installing rediwall® above fire exit discharges:  – When applying finishes e, f or g, installation of an appropriate fire-stopping system in the cavity is considered essential.  – When unclad rediwall® (type a finish) or when applying finishes h or i, appropriate protection over/near fire exit discharges as detailed in this assessment is required. <sup>4</sup>  – When apply finish b, no additional measures are required.

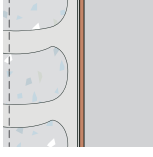
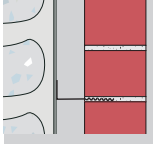
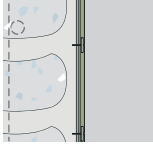
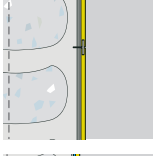
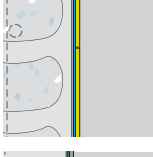
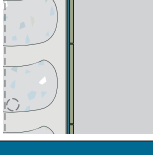
Continued on next page...

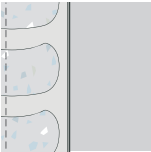
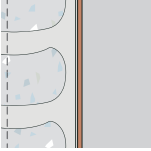
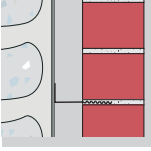
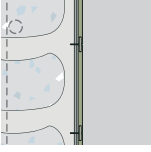
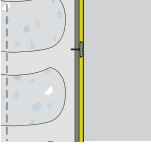
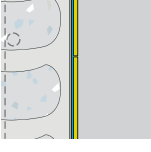
Applications	Compliance with NCC Performance Requirements	Finishes	Safety Measures
<p><b>Retaining walls (external face of panel)</b> (Assessment 10A)</p>	<p>PVC formwork is not considered to affect compliance with C1P1 and C1P2 (NCC2019 CP1 &amp; CP2)</p>	<p>a. Unclad PVC lining left in place </p> <p>j. With membrane </p>	<p>No additional measures are required as fire spread and development of untenable conditions due to PVC formwork as well as over-cladding has been determined to be unlikely, subject to the following:</p> <p>– For finish j, the membrane is to be buried below ground.</p>
<p><b>Openings in fire resisting walls</b> (Assessment 11B)</p>	<p>PVC formwork is not considered to affect compliance with C1P1 and C1P2 (NCC2019 CP1 &amp; CP2)</p>	<p>a. Unclad PVC lining left in place </p> <p>b. Non-combustible cement render or similar render finish over unclad rediwall® </p> <p>e. Face brick with inner rediwall® skin forming a cavity wall </p> <p>f. Mechanically fixed tile system (&lt;32kg/m²) to unclad rediwall® </p> <p>g. Mechanically fixed non-combustible cladding to unclad rediwall® </p> <p>h. Direct-stick non-combustible cladding + adhesive to unclad rediwall® </p> <p>i. Glue-fixed tile systems (&lt;32kg/m²) + adhesive to unclad rediwall® </p>	<p>No additional measures are required as fire spread and development of untenable conditions due to PVC formwork as well as over-cladding has been determined to be unlikely, subject to the following:</p> <p>– When applying finishes e, f or g, installation of an appropriate fire-stopping system<sup>3</sup> in the cavity is considered essential.</p>
<p>Continued on next page...</p>			

Applications	Compliance with NCC Performance Requirements	Finishes	Safety Measures
<p><b>Rediwall® used externally at less than 2m above the ground</b> (Assessment 12A)</p>	<p>PVC formwork is not considered to affect compliance with C1P1 and C1P2 (NCC2019 CP1 &amp; CP2)</p>	<p>a. Unclad PVC lining left in place </p> <p>b. Non-combustible cement render or similar render finish over unclad rediwall® </p> <p>e. Face brick with inner rediwall® skin forming a cavity wall </p> <p>f. Mechanically fixed tile system (&lt;32kg/m²) to unclad rediwall® </p> <p>g. Mechanically fixed non-combustible cladding to unclad rediwall® </p> <p>h. Direct-stick non-combustible cladding + adhesive to unclad rediwall® </p> <p>i. Glue-fixed tile systems (&lt;32kg/m²) + adhesive to unclad rediwall® </p>	<p>If the over-cladding extends beyond the extent of the rediwall®, installation of an appropriate fire-stopping system<sup>3</sup> in the cavity at the top of the rediwall® over-cladding is considered essential.</p>

1. This table is based on the Stephen Grubits & Associates rediwall Codemark Certification report, 2013/277.78 R1.6

3. Installation of a fire-stopping system would include but is not limited to systems such as Rockwool™ cavity barrier, intumescent or steel cavity barrier or similar in between rediwall® external wall and cladding system where a continuous cavity from one floor to another floor is created. It is recommended that a fire-stopping product is to be installed where the continuous cavity starts and on the level of floor slab that is separating floors, in a horizontal manner.

4. Protection over/near external fire exits (i.e where rediwall® is installed over or near external fire exits) includes:

- Removal of the PVC lining, or
- Construction of a non-combustible overhead protection (e.g. awning) with the minimum requirements of:
  - Construction to be made of non-combustible material, and be able to resist the impact of falling debris, and
  - Projection of the overhead protection to be:
    - Parallel to the external wall with an overall width equal to the fire exit doorway width plus 300mm extending either side of the doorway, and
    - Extending a perpendicular distance of 3m minimum from the external wall.



## Non-Combustibility – Specific Wall Applications

In addition to the general rediwall® applications with associated applied finishes, a number of specific rediwall® applications have also been assessed by Stephen Grubits & Associates, Fire Safety Engineers in Report 2013/277.78 R1.6 to confirm compliance with the relevant Performance Requirements, NCC 2022 C1P1, C1P2, C1P3, C1P4, C1P7 and C1P8 (NCC2019 CP1, CP2, CP3, CP4, CP7 and CP8).

### Rediwall® as a Boundary Wall

Based on the following arrangement, the rediwall® Boundary Wall has been assessed to achieve compliance to the relevant Performance Requirement of the NCC 2022 C1P1 and C1P2 (NCC2019 CP1 & CP2).

This is achieved when unclad rediwall® is used as an external boundary wall and is located directly adjacent to an existing non-combustible fire resisting external boundary wall forming a cavity no greater than 50mm, there are no openings in either wall (unless it is a fire window as specified in the NCC), both walls can be of different height. The top and sides of the cavity space are to be fully enclosed by non-combustible flashing of appropriate size to suit the wall(s) configuration.

**Fig A39: Rediwall® Boundary Wall Capping (elevation view)**

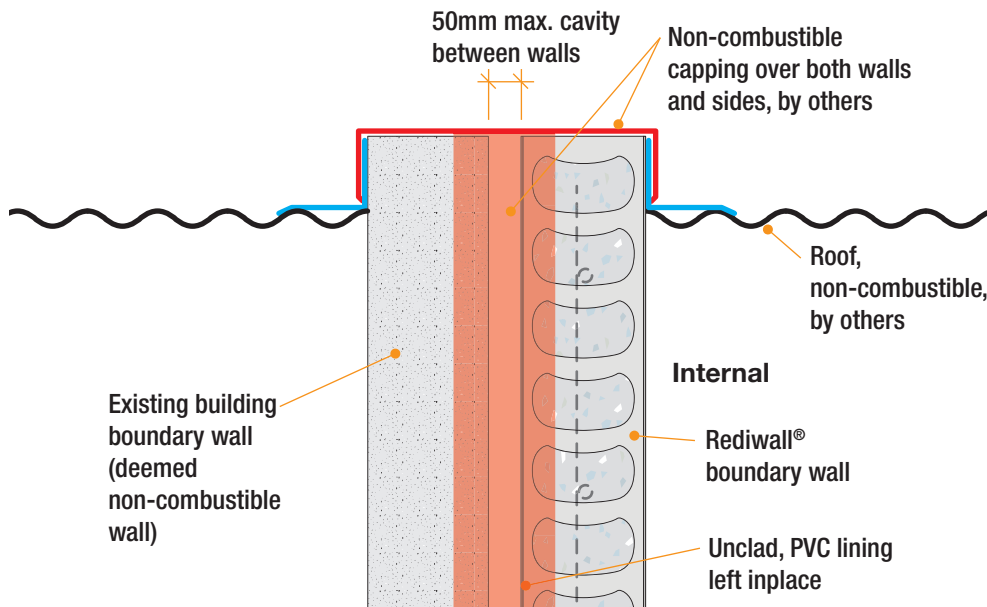

**Fig A40: Rediwall® Boundary Wall with Different Wall Heights**

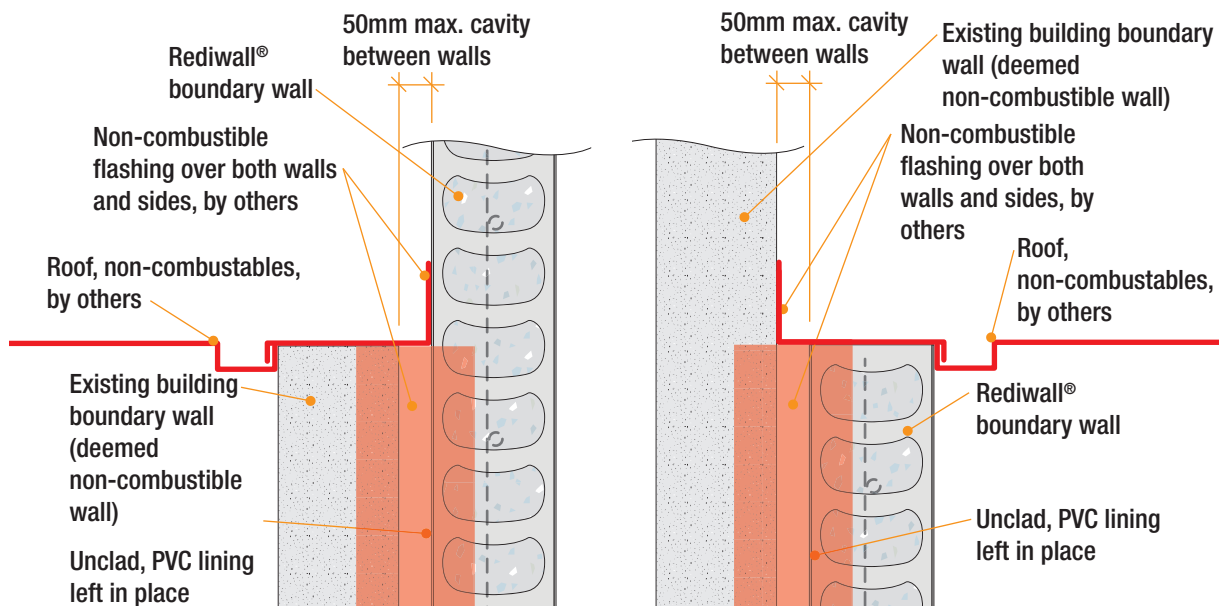

## Fire Rated Junction (Internal Rediwall® to External Logicwall® or internal Rediwall® to internal Rediwall®)

When a junction is formed between a rediwall® (internal fire rated wall) and a Logicwall (external fire rated wall), or where a rediwall (internal fire rated wall) abutts end to end with another rediwall (internal fire rated wall), and the junction is required to be fire-resisting.

In order to seal the gap and maintain the appropriate integrity and insulation criteria of the FRL, fire-resisting sealant such as Fosroc Flamex, CSR FireSeal or similar that has been tested to AS1530.4 must be installed so that the sealant continuously fills the gap between the fibre cement face on each side of the junction and backing rod.

The required insulation and integrity FRL values are achieved by meeting the width and depth of the fire rated sealant as per the sealant manufacturer's specifications.

Based on these arrangement, rediwall® has been assessed to achieve compliance to the relevant Performance Requirements, NCC 2022 C1P1,C1P2 and C1P4 (NCC2019 CP1,CP2 & CP4). Refer to Fig A41.

**Fig A41: Internal Rediwall® to External Logicwall Fire Rated Junction**

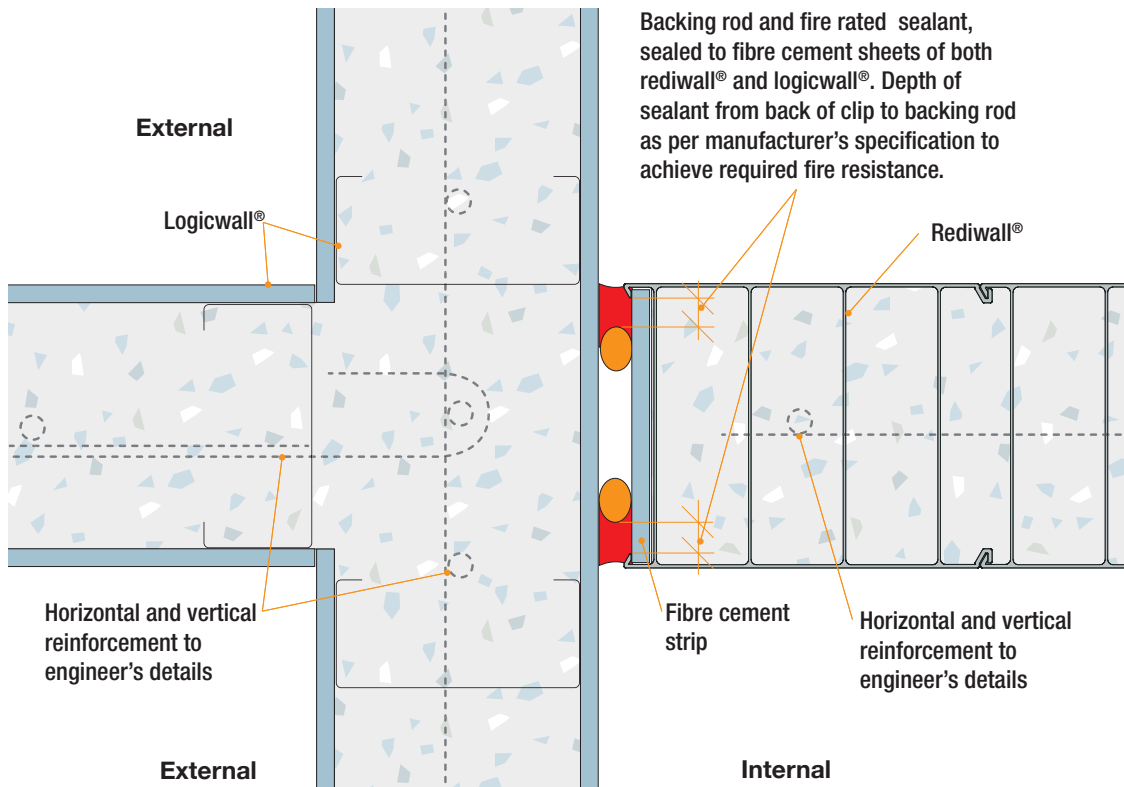

**Fig A42: Rediwall® to Rediwall® Fire Rated End Junction**

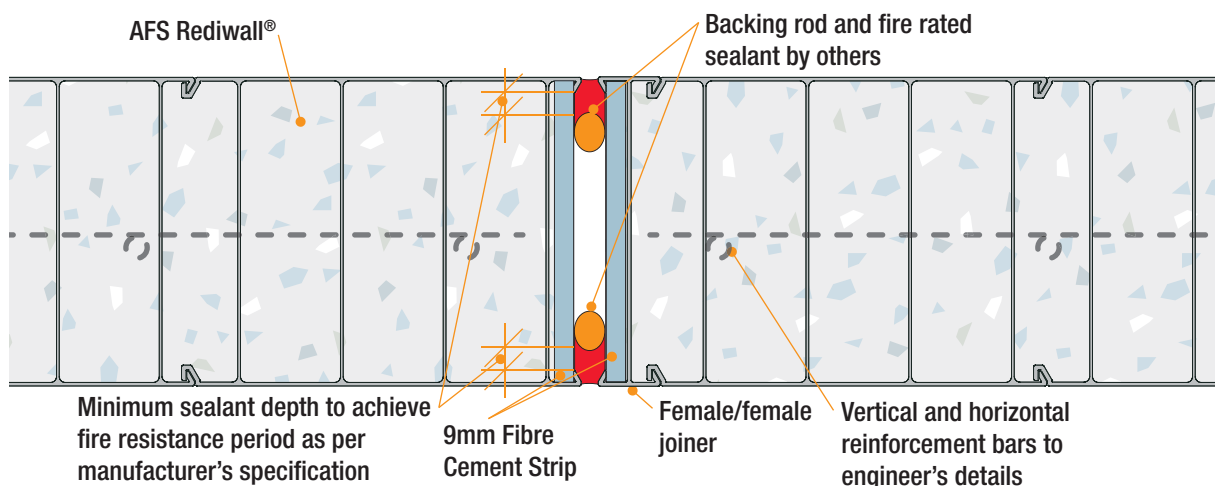

## Rediwall® Fire rated T-junction

A T-junction system incorporating the rediwall® T-Joiner (or floor track) is suitable to protect from the spread of fire across the junction. The joint is sealed by the concrete core which is filled so that it flows across the joint, and is strengthened by steel reinforcing across the joint.

Both walls are of the same FRL, each wall is expected to expand and deform at comparable rates when subjected to the heat of a fire. The concrete that bounds the joint is expected to act as a heat sink to any fire products passing through the junction. The concrete would therefore not permit the transfer of sufficient heat (either by radiation or by the transmission of hot gases) to enable ignition on the non-fire side of the rediwall®, thereby resisting fire spread between compartments.

Based on this particular arrangement, the rediwall has been assessed to achieve compliance to the relevant Performance Requirements, NCC2022 C1P1,C1P2 and C1P4 (NCC2019 CP1,CP2 & CP4).

**Fig A43: Rediwall® T-Junction**

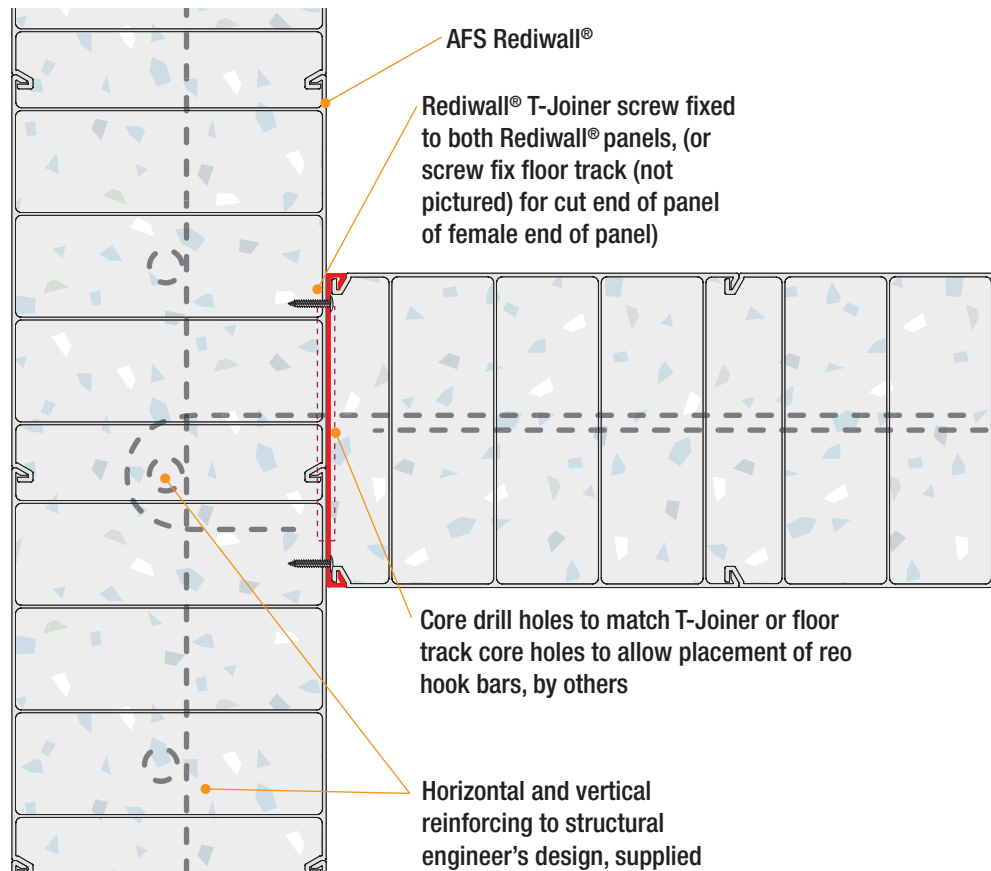

## Rediwall® Fire Rated Penetrations

AFS Rediwall® has been tested and assessed by CSIRO (test report FSV 2094 and assessment report FCO 3380) to AS1530.4 for fire resistance levels of various service penetrations to achieve up to FRL –/120/120 for service penetrations in the Rediwall® without the need to remove the PVC lining.

Service penetration types tested and assessed include:

- Clay Brick Infill
- Cable trays
- PVC Pipe work
- Electrical Cable (Single or bundled)
- Copper and metal pipe work
- Fire Dampers FRL –/120/– (Integrity)

These service penetrations types are allowed to be used through Rediwall® RW110C, RW156C, RW200C, RW256S, RW275S and RW300S with penetration apertures as close as 40mm spacing.

**TABLE A12: AS1530.4 –Rediwall® Service Penetration FRL Rating and Protection Measures**

Service Penetration Type	RW110C	RW156C, RW200C, RW256S, RW275S, RW300S
Cable Trays or Bundled Cables	<p><b>FRL –/120/120</b></p> <p>Promat Supawrap PLUS Promat Promaseal A Sealant</p> <p>OR</p> <p>ANY sealant tested or assessed for FRL –/120/120 when protecting AS1530.4 appendix D1 Group A cable configurations in concrete walls <b>105mm</b> thick or less.</p>	<p><b>FRL –/120/120</b></p> <p>Promat Supawrap PLUS Promat Promaseal A Sealant</p> <p>OR</p> <p>ANY sealant tested assessed for FRL –/120/120 when protecting AS1530.4 appendix D1 Group A cable configurations in concrete walls <b>150mm</b> thick or less.</p>
Cables or PVC pipes	<p><b>FRL –/120/120</b></p> <p>Promat Promaseal FC100 Fire Collar</p> <p>OR</p> <p>ANY fire collar tested or assessed for FRL –/120/120 protecting plastic pipes in concrete walls <b>105mm</b> thick or less</p>	<p><b>FRL –/120/120</b></p> <p>Promat Promaseal FC100 Fire Collar</p> <p>OR</p> <p>ANY fire collar tested or assessed for FRL –/120/120 protecting plastic pipes in concrete walls <b>150mm</b> thick or less</p>
Copper Pipes or Metal Pipes	<p><b>FRL –/120/120</b></p> <p>Promat Supawrap &amp; metal pipe clamps PLUS Promat Promaseal A Sealant (with sealant depth to 20mm in wall)</p> <p>OR</p> <p>ANY sealant tested in or assessed for FRL –/120/120 protecting AS1530.4 appendix E metal pipe configurations in concrete <b>105mm</b> thick or less, (with increase sealant depth to 20mm into wall)</p>	<p><b>FRL –/120/120</b></p> <p>Promat Supawrap &amp; metal pipe clamps PLUS Promat Promaseal A Sealant (with sealant depth to 20mm in wall)</p> <p>OR</p> <p>ANY sealant tested or assessed for FRL –/120/120 protecting AS1530.4 appendix E metal pipe configurations in concrete <b>150mm</b> thick or less, (with increase sealant depth to 20mm into wall)</p>
Brickwork Infill	<p><b>FRL –/120/120</b></p> <p>Clay Bricks + Render infill in accordance to AS3700 with CSR Fireseal Sealant sealed perimeter of infill</p> <p>OR</p> <p>use of FRL –/120/120 rated Blocks/Bricks</p>	
Fire Dampers	<p><b>FRL –/120/–</b></p> <p>Bullock Model 4900 Curtain Fire Damper (6mm FC sheet around damper frame to PVC facing both sides)</p> <p>OR</p> <p>ANY conventional curtain/blade fire damper tested or assessed for –/120/– to AS1530.4 in concrete walls <b>150mm</b> thick</p>	
<p>Note: Installation must be in accordance with manufacture's requirements. For further information refer to CSIRO assessment report FC3380</p>		

## Acoustic Performance

Acoustic performance requirements for a building project are determined by the NCC, local authorities and the developer requirements. A typical wall separating sole occupancy units is required to have an  $R_w+C_{tr}$  not less than 50 when measured in an acoustic laboratory.

### Laboratory and Field Performance



There is however the verification clause that states that when the wall is installed in the actual dwelling that it shall achieve not less than a  $D_{nt,w}+C_{tr}$  of 45. In the end, it is the field conditions that dominate, as people do not live in acoustic laboratories. It is important that all the components in the chain of providing sound insulation have adequate performance and it is critically important to demonstrate in an acoustic laboratory that the chosen element has the potential performance.

### Acoustic Performance

The acoustic performance of the rediwall® systems in various wall configurations have been assessed by Acoustic Logic Consultancy Pty Ltd.

The TABLE A13 provides acoustic performance ratings for unclad rediwall systems with PVC in place. These systems have been assessed by Acoustic Logic Consultancy Pty Ltd.

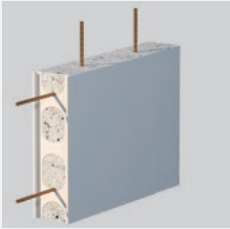
TABLE A13: Acoustic Performance Ratings for Standard Rediwall® Wall Systems (unclad with PVC in place)

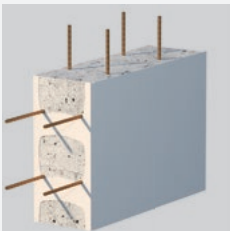
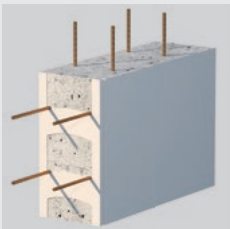
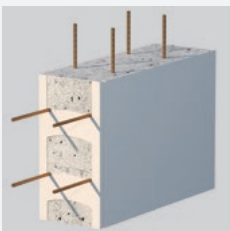
Rediwall® System	Description		$R_w$	$C_{tr}$	$R_w+C_{tr}$
RW110C	110mm thick wall 105mm of concrete core		50	-5	45
RW156C	156mm thick wall/ 151mm of concrete core		54	-4	50
RW200C	200mm thick wall 195mm of concrete core Single or double reinforcement options		58	-5	53
RW256S	Double reinforcement, 251mm of concrete core		60	-5	55
RW275S	Double reinforcement, 270mm of concrete core		61	-5	55
RW300S	Double reinforcement, 295mm of concrete core		61	-5	55

Some typical rediwall® wall configurations and their assessed acoustic performance are given below. For further assistance on wall configurations and acoustic performance assessments, please contact AFS Technical Services.

**TABLE A14: Sample Rediwall® Wall System Applications – Acoustic Performance Ratings**

Rediwall®	Typical Application	Rediwall® System 1	R <sub>w</sub>	C <sub>tr</sub>	R <sub>w</sub> +C <sub>tr</sub>
RW110C	External or dry to common area	afs rediwall® 110mm, 20mm air gap, 64mm Rondo Stud frame, Bradford Acoustigard insulation (75mm R1.8), 6mm Ceminseal Wallboard	62	-10	52
RW156C	External or dry to common area	afs rediwall® 156mm, 20mm air gap, 64mm Rondo Stud frame, Bradford Acoustigard insulation (75mm R1.8), 6mm Ceminseal Wallboard	65	-10	55
RW156C	Inter-tenancy dry to dry	13mm Gyprock Standard Plasterboard, 64mm Rondo Stud frame, Bradford or Martini non-rigid insulation (11kg/m <sup>2</sup> ), 20mm air gap, afs rediwall® 156mm, 13mm Gyprock Standard Plasterboard	65	-10	55
RW156C	Inter-tenancy wet to wet	6mm Ceminseal wallboard, 64mm Rondo Stud frame, Bradford or Martini non-rigid insulation (11kg/m <sup>2</sup> ), 20mm air gap, afs rediwall® 156mm, 20mm air gap, Bradford or Martini non-rigid insulation (11kg/m <sup>2</sup> ), 64mm Rondo Stud frame, 6mm Ceminseal wallboard	>70	-10	>60
RW156C	Inter-tenancy dry to service shaft	13mm Gyprock Standard Plasterboard, afs rediwall® 156mm, 20mm air gap, Bradford or Martini non-rigid insulation (11kg/m <sup>2</sup> ), 64mm Rondo Stud frame, 6mm Ceminseal wallboard	65	-10	55

1 To achieve a discontinuous construction a separate stud wall is required. To maintain discontinuous construction the plumbing or other services must be run within the studs of the separating wall. There must be no direct connection between the plumbing services and the afs rediwall® wall other than at the perimeter.

## Thermal Insulation

A primary objective for a designer when planning a building is to design a building fabric – external elements such as ceilings, roofs and floors, that will deliver a cost effective, comfortable living or working environment for the inhabitants.

AFS rediwall® walls being a monolithic concrete barrier possess inherent features which greatly assist the designer in achieving the objective of thermal mass and air tightness.

## Energy Efficiency

The NCC contains thermal performance requirements in terms of **minimum Total R** for building fabric (the external ceilings, floors and walls) of new buildings in Australia.

The total R-Value is the total thermal resistance of a building surface, including indoor and outdoor air film resistance.

## Thermal Insulation & Mass

The NCC recognises the benefit of thermal capacity or mass, and so provides R concessions for heavyweight walls such as afs rediwall® walls.

Heavy mass delays the transfer of outdoor temperature variations, improving indoor comfort. The concrete construction of afs rediwall® walls provides a significant thermal mass barrier to the external elements. If necessary additional insulation materials may be installed with afs rediwall® walls to achieve higher R-values specified by the BCA. This in turn not only enhances occupant comfort, but also reduces heating/cooling costs and may also improve the acoustic performance of the wall. Insulation materials should be installed with afs rediwall® walls so as to form a continuous thermal barrier.

## Condensation Management

An afs rediwall® external wall system can comply to the NCC 2022 Pliable Building Membrane deemed to satisfy provisions where the rediwall® as the external wall can have a vapour permeable pliable building membrane (complaint to AS4200.1 and AS4200.2) installed by others to the inside face of the rediwall® prior to any insulation layer, then internal wall lining system. Refer to Volume 2 - Detailing & Finishing Guide wall system details.

Consideration should be taken for poor sealing and high-level open wall vents, water vapour from clothes dryers, showers and baths was carried from the building before condensing. With increased insulation and better techniques for preventing heat loss, make it more difficult for water vapour to exit the dwelling as there are no air gaps for the air to carry it away, so it condenses on the coolest surface, typically the window glass can be more prevalent, however, it is an 'operational' issue rather than a building fault.

Activities such as failing to run fans while showering and while a room dries out, drying clothes inside without a dryer and exhaust fan operating, and appliances such as food steamers, kettles, urns and humidifiers, all contribute to water vapour and therefore potentially to condensation. The formation of condensation typically illustrates that the building is well sealed against draughts and is well insulated.

Prevention of condensation can be achieved by the following common practices:-

- Running bathroom fans while showering and leaving them on for a time afterwards.
- Dry clothes outside, in a dryer with the laundry fan running or on a rack in the bathroom with the bathroom fan running, or in a communal drying facility.
- Avoid using humidifiers and other appliances which create steam/water vapour.
- If using steamers, urns or boiling water, ensure the rangehood is operating. (Rangehoods should exhaust to outside and must not be recycling type.)
- Leave windows ajar some of the time, particularly in bathrooms.
- Consider opening the outside doors and windows for a few minutes each day to 'flush out' humid air.



## AFS Rediwall® Thermal Performance

AFS Rediwall® wall systems have been assessed for their thermal performance by thermal efficiency consultants, James M Fricker Pty Ltd (JMP). The thermal performance assessments in accordance with AS/NZS 4859.1 – 2018 for the rediwall® unclad walls with PVC in place are detailed in the following table.

Rediwall® System	Thermal Resistance
RW110C	R 0.091m <sup>2</sup> K/W
RW156C	R 0.123m <sup>2</sup> K/W
RW200C	R 0.153m <sup>2</sup> K/W
RW256S	R 0.192m <sup>2</sup> K/W
RW275S	R 0.205m <sup>2</sup> K/W
RW300S	R 0.223m <sup>2</sup> K/W

Total R-value thermal assessments have been performed for a variety of afs rediwall® wall configurations.

The following table provides examples of some afs rediwall wall system configurations along with their total R-values.

For assistance with additional rediwall® wall configurations and thermal performance assessments, please contact AFS Technical Services.

**TABLE A15: Examples of AFS Rediwall® Wall System Configurations and Thermal Performance Total R-Values**

AFS Rediwall®	Composition	System Overview	Total R- Value	
			Summer	Winter
RW156C	<ul style="list-style-type: none"> <li>– RW156C</li> <li>– 28mm Rondo furring channel on Betafix Clip</li> <li>– Bradford 25mm PIR for CClass 1&amp;10 buildings</li> <li>– 6mm Cemintel Wallboard</li> </ul>		1.61	1.75
RW156C	<ul style="list-style-type: none"> <li>– RW156C</li> <li>– 28mm Rondo furring channel on Betafix Clip</li> <li>– Bradford 25mm PIR for CClass 1&amp;10 buildings</li> <li>– 13mm Gyprock standard plasterboard</li> </ul>		1.67	1.81
RW156C	<ul style="list-style-type: none"> <li>– RW156C</li> <li>– 20mm air gap</li> <li>– 64mm Rondo stud frame</li> <li>– Bradford Acoustigard 75mm R1.8</li> <li>– 13mm Gyprock standard plasterboard</li> </ul>		2.24	2.44

## Weatherproofing

For any external façade design applicable to a building, it is essential that the system adopted is capable of withstanding the various environmental conditions which the façade is subject to during its life. In particular the prevention of water ingress into the building is critical. afs rediwall® as an external façade, with an applied weatherproofing coating performs as a successful barrier to water ingress, and has been tried and proven on numerous buildings, many of which are in coastal locations. The system chiefly relies upon the following:

1. Adoption of horizontal slab junction details as recommended by AFS. Refer to Volume 2 for further details.
2. The water resistance of the PVC face used in afs rediwall® itself.
3. Appropriate location of flashings, especially to cap exposed parapet walls typically located on the top level of buildings.
3. Correct application of a quality external weatherproofing coating system to supplier's specifications.

AFS Rediwall® systems will comply with the weatherproofing performance verification methods NCC2019 FV1.1 Weatherproofing (Volume 1) and V2.2.1 (Volume 2) of the National Construction Code, in accordance with the report 'Weatherproofing to Xavier Knight report April 2022.

## Termite Resistance

Australian Standard AS 3660.1 – Termite Management – New building works, Clause 4.3.2.2 confirms that as long as the construction joints at the wall/concrete slab junction are designed and constructed in accordance with AS2870 or AS3600, no other termite treatment is required as the junction becomes a suitable termite barrier.

Furthermore, rediwall®, consisting of concrete elements designed and constructed in accordance with AS3600 as a monolithic construction, together with PVC linings in accordance with AS3660.1, Clause 3.2, is deemed to be termite resistant.

## Bushfire Resistance

AFS Rediwall® is suitable for use in external wall construction in designated bushfire prone areas. Rediwall® systems have been fire tested to confirm Fire Resistance Levels of 60/60/60 up to 240/240/240. Refer to the Fire Resistance Levels section of this guide.

Australian Standard AS3959 – Construction of buildings in bushfire prone areas, Clause 9.4, Item C, and Cl 3.4 confirm that external wall systems with an FRL 30/30/30 or –/30/30 or higher are suitable for all Bushfire Attack Levels (BAL), i.e. BAL-Low to BAL-FZ.

For further details, refer to the latest Codemark requirements for bushfire construction provisions.

# Appendices

---

The following are sample documents for:

## AFS Rediwall® Standard Bracing & Lifting Bar

AFS Rediwall Standard Bracing Drawing and Certificate

AFS Rediwall® approved N16 Lifting Bar Drawing and Certification

## Certifications

### Rediwall® Codemark Certification

CM30107

### Fire Resistance Level (FRL)

AS1530.4 FRL Fire Test Certificates

AS1530.4 FRL Assessment Report

AS1530.4 FRL Service Penetration Test and Assessment Report

### Non-combustibility and Fire Performance

Stephen Grubits & Associates Safety Engineers, Rediwall® – Non-Combustibility Assessment Report

AS5113 Facade Fire Test Report

AS5637.1 Classification (AS/ISO 9705 Room Test) Report

AS1530.3 Fire Hazard Properties Fire Test Certificates

### Acoustic Performance

Acoustic Logic Consultancy – Acoustic Performance Certificates for – RW110C, RW156C, RW200C, RW256S & RW300S.

### Thermal Performance

James M Fricker Pty Ltd – R-value certificates – RW110C, RW156C, RW200C, RW256S, RW275S and RW300S.

### Weatherproofing

Xavier Knight Weatherproofing Verification Report.

# AFS Rediwall Standard Bracing

- Notes:**
1. Ensure correct anchors & fixing used as per the table for the relevant height & AGLZ.
  2. Refer AFS installation manual for installation guidelines.
  3. Braces to remain in place until top of wall stabilised by structure or as instructed by engineer.
  4. Installation contractor to review for suitability and inclusion in the project programme.
  5. Braces to be inspected on return for damage, straightness & play in fittings, any defective braces to have tagging removed & brace discarded or repaired.
  6. Based on maximum brace installation period of 4 days for empty panels.
  7. AFS engineer/inspector inspection required after installation of bracing prior to concrete pour.
  8. Bracing to remain in place until wall stabilised by structure or project engineer approval.

Minimum Ultimate Design Capacity 1kg Tek screws into LOGICWALL Panel, kN  
Interaction of Shear and Tension Load into Joint (Loads as Provided by AFS/CSR in Tested Report Dated 14/11/16)

Type	Minimum Design Capacity, kN
1kg Timber Tek screws	1.46
1kg Timber Tek screws-15mm Backing Plate	4.18

Region	Non Cyclonic A1-A7
Terrain Category	T/C3
V-100yr <sup>2</sup>	41 m/s

(ref AS1702)

Top Anchor Alternatives	Bottom Anchor Alternatives	Maximum Height Floor AGLZ)
1kg Timber Tek screws + 15mm Backing Plate	HHI HUS-HI HHI HUS-HI HHI HUS-HI	< 20m
4	10x90 14x80	Maximum Temporary Wall Height, mm
3	1 1 1	1900
2	1 1 1	1750
		1500

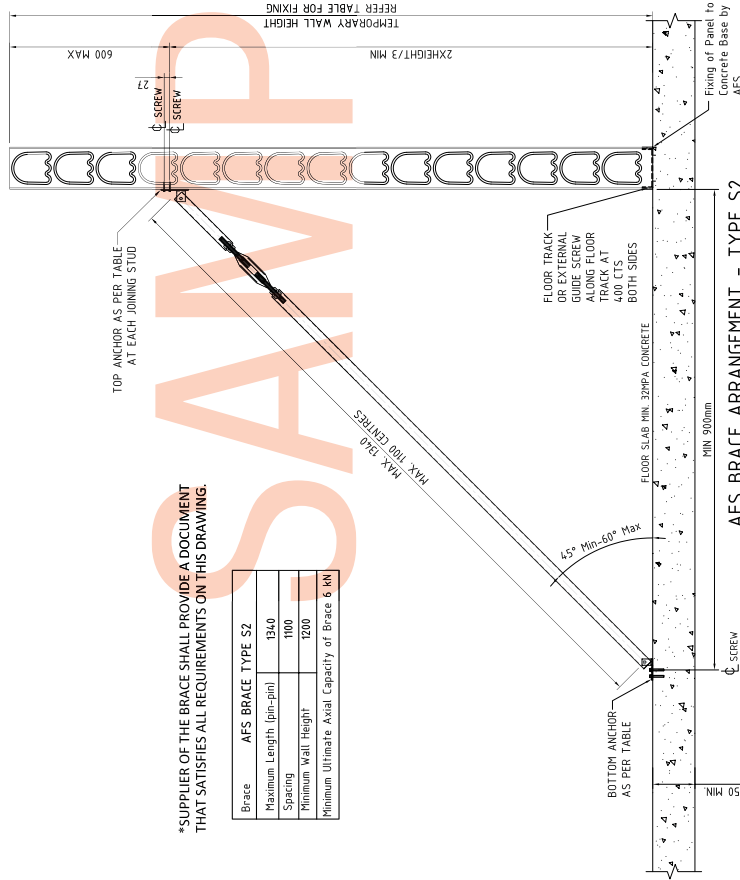

Brace	AFS BRACE TYPE S2
Maximum Length (pin-pin)	1340
Spacing	1000
Minimum Wall Height	1200
Minimum Ultimate Axial Capacity of Brace	6 kN

S2

<b>DATE</b>	<b>REV</b>	<b>BY</b>	<b>CHKD</b>	<b>APPD</b>	<b>DATE</b>
<b>PROJECT</b>					
AFS BRACE ARRANGEMENT TYPE S2					
<b>CLIENT</b>					
<b>PROJECT</b>					
P2351					
<b>SCALE</b>					
AS SHOWN					
<b>FORM</b>					
FORM IR					
<b>FORM</b>					
FORM IS					
<b>DATE</b>					
20/01/2023					
<b>REV</b>					
REV A					

myd CONSULTING ENGINEERS  
 LVL 2, 19 Howe Street  
 Pyrmont, NSW 2009  
 T: 02 9817 2611  
 E: info@mydconsulting.com

AFS  
 smarter permanent formwork

THE SUPPLIER OF THE BRACE SHALL PROVIDE A DOCUMENT THAT SATISFIES ALL REQUIREMENTS ON THIS DRAWING.

# AFS Rediwall® Standard Lifting Bar

**NOTES:**

- THIS LIFTING METHOD SHALL NOT BE USED FOR WIND SPEED GREATER THAN 154 KPH.
- THE BUILDER/INSTALLER IS RESPONSIBLE FOR ASSESSING RISKS AND DEVELOPING THEIR OWN PROTECTIVE SAFETY METHODS IN ACCORDANCE WITH THIS REFERENCE DOCUMENT & AFS MANUAL.
- MAXIMUM SIDE TILT: 10°

AFS LIFTING BAR TESTING NOV. 2019, UPDATED SWL & STABILITY OF THE LIFTING BAR WITHIN THE PANELS, THE DEFORMED BAR COGS & BENDS RETAINED THE LIFTING BAR WITHIN THE PANEL FOR SIDE TILTS GREATER THAN 60°.

**LIFTING L-BAR DETAIL**

**NARROW PANEL LIFT**

**TABLE 1: PANEL WIDTH AND LIFTING BAR DIMENSIONS**

PANEL WIDTH (mm)	L-BAR DIMENSION 'X' (mm)	SWL (KG)
750 ONLY	550	80 SINGLE STRAP
250-500	550	160
500 - 750	750	250
750 - 1000	1050	300

**NOTES:**

- LIFTING BAR TO FULLY ENGAGE ALL WEBS WITH TWO FULL INTACT WEBS OVER LIFTING BAR
- LIFTING BAR TO FULLY ENGAGE MINIMUM OF 2 STUDS EACH SIDE OF THE LIFTING STRAP
- LIFTING BAR TO BE LOCATED AT LEAST 2 COMPLETE STUD HOLES BELOW THE TOP OF LOGIC WALL PANEL

**SIDE ELEVATION**

**FRONT ELEVATION**

**AFS REDIWALL® PANEL**

**REDIWALL - 18mm WEBS @ 70 MAX. CTS.**

**MAXIMUM PANEL WEIGHT REFER TO TABLE 1**

**myd. ENGINEERS**  
 Lvl 2, 19 Harris Street  
 Pyrmont, NSW 2009  
 T: 02 9817 2611  
 E: info@mydconsulting.com

**afs** smarter permanent formwork.

PROJECT: REDIWALL LIFTING BAR DETAILS  
 DRAWN: JN  
 CHECK: JN  
 DATE: 19/02/23  
 REV: 01  
 DWG NO: AFS-LB-RW

## Rediwall® CodeMark Certificate of Conformity

<b>Certificate of Conformity</b>		<b>Certificate number: CM 30107 Rev 5</b>
<b>THIS TO CERTIFY THAT</b>		
<b>AFS REDIWALL®</b>		
<p><b>Type and/or use of product:</b></p> <p>AFS REDIWALL® is a permanent formwork system for internal and external loadbearing and non-loadbearing reinforced concrete walls with structural, fire, weatherproofing, acoustic and thermal performance characteristics.</p>	<p><b>Description of product:</b></p> <p>AFS REDIWALL® comprises:</p> <ol style="list-style-type: none"> <li>1. Interlocking PVC panel extrusions as permanent formwork, and associated PVC accessories.</li> <li>2. Fibre cement sheet or PVC end closures.</li> <li>3. Reinforcing steel.</li> <li>4. Concrete fill.</li> <li>5. A range of finishing options as described in A2.</li> </ol> <p>AFS REDIWALL® types are as follows, the numerical values representing the thickness of the wall in millimetres:</p> <ol style="list-style-type: none"> <li>1. RW110C Single Reinforcement.</li> <li>2. RW156C Single Reinforcement.</li> <li>3. RW200C Single or Double Reinforcement.</li> <li>4. RW256S Double Reinforcement.</li> <li>5. RW275S Double Reinforcement.</li> <li>6. RW300S Double Reinforcement.</li> </ol>	<p style="text-align: right;"><b>BCA 2022</b></p>
<b>COMPLIES WITH THE FOLLOWING BCA PROVISIONS AND STATE OR TERRITORY VARIATION(S)</b>		
<p><b>Scope of certification:</b> The CodeMark Scheme is a building product certification scheme. The rules of the Scheme are available at the ABCB website <a href="http://www.abcb.gov.au">www.abcb.gov.au</a>. This Certificate of Conformity is to confirm that the relevant requirements of the Building Code of Australia (BCA) as claimed against have been met. The responsibility for the product performance and its fitness for the intended use remain with the certificate holder. The certification is not transferrable to a manufacturer not listed on Appendix A of this certificate.</p> <p><b>Disclaimer:</b> The Scheme Owner, Scheme Administrator and Scheme Accreditation Body do not make any representations, warranties or guarantees, and accept no legal liability whatsoever arising from or connected to, the accuracy, reliability, currency or completeness of any material contained within this certificate; and the Scheme Owner, Scheme Administrator and Scheme Accreditation Body disclaim to the extent permitted by law, all liability (including negligence) for claims of losses, expenses, damages and costs arising as a result of the use of the product(s) referred to in this certificate.</p> <p>The purpose of Global-Mark construction site audits is to confirm the practicability of installing the product; and to confirm the appropriateness and accuracy of installation instructions.</p> <p>In placing the CodeMark mark on the product/system, the certificate holder makes a declaration of compliance with the certification standard(s) and confirms that the product is identical to the product certified herein. In issuing this Certificate of Approval Global-Mark has relied on the expertise of external bodies (laboratories, and technical experts).</p>		
<p><b>Herve Michoux</b> Global-Mark Managing Director</p>	<p><b>Peter Gardner</b> Unrestricted Building Certifier</p>	<p><b>Date of issue: 01/05/2023</b> <b>Date of expiry: 10/05/2025</b></p>
<p>Certificate number: CM30107</p> <p style="text-align: right;">This certificate is only valid when reproduced in its entirety. Page 1 of 17</p>		



Global-Mark Pty Ltd,  
Suite 4.07, 32 Delhi  
Road, North Ryde  
NSW 2113, Australia

Tel: +61 (0)2 9886  
0222 - [www.Global-Mark.com.au](http://www.Global-Mark.com.au)

**Certificate Holder:**

AFS Systems Pty Ltd  
110 Airlds Road  
Minto, NSW, 2566  
Tel: 1300 727 237  
[afsformwork.com.au](http://afsformwork.com.au)

## AFS Rediwall® Fire Resistance Level (FRL) Reports

## INFRASTRUCTURE TECHNOLOGIES

www.csiro.au

14 Julius Avenue, North Ryde NSW 2113  
 PO Box 310, North Ryde NSW 1670, Australia  
 T (02) 9490 5444 • ABN 41 687 119 230



## Certificate of Test

No. 2667

"Copyright CSIRO 2015 ©"

Copying or alteration of this report  
 without written authorisation from CSIRO is forbidden.

This is to certify that the element of construction described below was tested by the CSIRO Infrastructure Technologies in accordance with Australian Standard 1530, Methods for fire tests on building materials, components and structures, Part 4-2005 on behalf of:

AFS Products Group Pty Ltd  
 22-24 Sommerville Circuit  
 Emu Plains NSW

A full description of the test specimen and the complete test results are detailed in the Division's Sponsored Investigation report numbered FS/ 1704.

Product Name: Load-bearing 150-mm thick AFS 150 Rediwall Panel structural wall system.

**Description:** The specimen comprised a reinforced concrete wall system 3000-mm high x 3000-mm wide x 150-mm thick made up of twelve pre-fabricated permanent formwork panels core-filled with concrete after assembly. The pre-fabricated permanent formwork system comprised 250-mm wide x 3000-mm high x 150-mm thick AFS 150 Rediwall panels. The extruded PVC panels comprised 2.5-mm thick perforated internal webs spaced at nominally 80-mm centres, as shown in drawing numbered AFS-DT-345, dated 8 April 2015, by AFSSystems Pty Ltd. The panels interconnected vertically by integrated sliding male to female connectors to form a hollow panel wall. The ends of the wall were finished with solid End Caps, while the bottom consisted of a perforated Floor Track. The wall was reinforced with N12 reinforcing bars at 350-mm centres vertically and 400-mm centres horizontally. The panels were appropriately braced and 32 Mpa, 120-mm slump concrete mix was pumped in through the top openings and trowelled off along the top, when completely filled. A total load of 700 kN was applied to the specimen for the duration of the test. The load requested by the client, was applied uniformly along the top of the wall.

The element of construction described above satisfied the following criteria for fire-resistance for the period stated.

Structural Adequacy	no failure at 241 minutes
Integrity	no failure at 241 minutes
Insulation	no failure at 241 minutes

and therefore for the purpose of Building Regulations in Australia, achieved a fire-resistance level (FRL) of 240/240/240. The FRL is applicable for exposure to fire from either direction.

This certificate is provided for general information only and does not comply with regulatory requirements for evidence of compliance.

Testing Officer: Chris Wojcik

Date of Test: 17 July 2015

Issued on the 7<sup>th</sup> day of August 2015 without alterations or additions.

Brett Foddy  
 Manager, Fire Testing and Assessments



NATA Accredited Laboratory  
 Number: 165  
 Corporate Site No 3625  
 Accredited for compliance with ISO/IEC 17025



## Certificate of Test

No. 2580

"Copyright CSIRO 2014 ©"

Copying or alteration of this report  
 without written authorisation from CSIRO is forbidden.

This is to certify that the element of construction described below was tested by the CSIRO Division of Materials Science and Engineering in accordance with Australian Standard 1530, Methods for fire tests on building materials, components and structures, Part 4-2005 on behalf of:

AFS Products Group Pty Ltd  
 22-24 Sommerville Circuit  
 Emu Plains NSW

A full description of the test specimen and the complete test results are detailed in the Division's Sponsored Investigation report numbered FSV 1654.

Product Name: 200-mm thick, load-bearing AFS 250 Rediwall Panel, structural wall system.

Description: The specimen comprised a reinforced concrete wall system 3000-mm high x 3000-mm wide x 200-mm thick made up of twelve pre-fabricated permanent formwork panels core-filled with concrete after assembly. The pre-fabricated permanent formwork system comprised 250-mm wide x 3000-mm high x 200-mm thick AFS 250 Rediwall panels. The extruded PVC panels comprised 2.5-mm thick perforated internal webs spaced at nominally 80-mm centres, as shown in drawing titled "AFS U250 Panel 200 THK Rediwall", dated 22 July 2014, by LMGDS Pty Ltd. The panels interconnected vertically by integrated sliding male to female connectors to form a hollow panel wall. The ends of the wall were finished with solid End Caps, while the bottom consisted of a perforated Floor Track. The wall was reinforced with N12 reinforcing bars at 350-mm centres vertically and 400-mm centres horizontally. The panels were appropriately braced and 32 Mpa, 120-mm slump concrete mix was pumped in through the top openings and trowelled off along the top, when completely filled. The concrete mix design is specified in Hanson Construction Materials Pty Ltd report in Appendix D. A total load of 1000 kN was applied to the specimen for the duration of the test. The wall specimen wall was constructed on 20 January 2014.

The element of construction described above satisfied the following criteria for fire-resistance for the period stated.

Structural Adequacy	no failure at 241 minutes
Integrity	no failure at 241 minutes
Insulation	no failure at 241 minutes

and therefore for the purpose of Building Regulations in Australia, achieved a fire-resistance level (FRL) of 240/240/240. The FRL is applicable for exposure to fire from either direction.

This certificate is provided for general information only and does not comply with regulatory requirements for evidence of compliance.

Testing Officer: Chris Wojcik Date of Test: 11 August 2014

Issued on the 5<sup>th</sup> day of September 2014 without alterations or additions.

Brett Roddy  
 Manager, Fire Testing and Assessments



This document is issued in accordance with NATA's accreditation requirements.  
 Accreditation No. 165 – Corporate Site No. 3625  
 Accredited for compliance with ISO/IEC 17025



Exova Warringtonfire Aus Pty Ltd  
 Unit 2, 409-411 Hammond Road  
 Dandenong Victoria 3175  
 Australia  
 T: +61 (0)3 9767 1000  
 F: +61 (0)3 9767 1001  
 W: www.exova.com



Testing. Advising. Assuring.

<b>EWFA CERTIFICATE OF ASSESSMENT</b>	<b>CERTIFICATE No : SFC 51713600.1</b>	<b>Page 1 of 2</b>
---------------------------------------	--	--------------------

Report Sponsor	Certificate Issue Date	Products Name
AFS Systems Pty Ltd 110 Airds Road Minto NSW 2566	17/04/2018	The fire resistance performance of AFS Rediwall loadbearing wall systems if tested in accordance with AS1530.4-2014

Assessment Report Reference	Referenced Standard	Report Issue Date	Report Validity Date
EWFA 5173600.1	AS1530.4-2014	17/04/2018	30/04/2023

#### Introduction

The element of construction described below was assessed by this laboratory on behalf of the report sponsor in accordance with the stated test standard and achieved the results stated below. Refer to the referenced test report for a complete description of the assessed construction.

#### Assessed systems description and performance

Based on the discussion presented in the assessment report, it is the opinion of this testing authority that if the specimen described in section 1 of the report had been modified within the scope of section 3, it will achieve the performance as stated below if tested in accordance with the test method referenced in Section 4 and subject to the requirements of Section 7:

**RW156C Wall System, FRL: 240/240/240, uniformly applied load is 700kN**

**RW200C Wall System, FRL: 240/240/240, uniformly applied load is 1000kN**

**RW256S Wall System, FRL: 240/240/240, uniformly applied load is 1000kN**

For full and detailed discription of the assessed systems please refer to assessment report EWFA 51713600.1

#### Conditions/Validity

- THIS CERTIFICATE IS PROVIDED FOR GENERAL INFORMATION ONLY AND DOES NOT COMPLY WITH THE REGULATORY REQUIREMENTS FOR EVIDENCE OF COMPLIANCE.
- Reference should be made to the relevant test report or regulatory information report to determine the applicability of the test result to a proposed installation. Full details of the constructions and justification for the conclusions given, along with the validity statements, are given in the assessment reports.
- The assessment report or short form assessment report does not provide an endorsement by Exova Warringtonfire Aus Pty Ltd of the performance of the actual products supplied. It is intended to provide a brief outline of the above referenced assessment reports and not to replace them.
- The conclusions in this certificate of assessment relate to the configurations as detailed, and should not be applied to any other configuration. The conclusions expressed in this document assess fire hazard, but it should be recognised that a single test method will not provide a full assessment of fire hazard under all conditions.
- Full copies of the assessment and relevant test reports may be obtained from the sponsor.



STEPHEN GRUBITS & ASSOCIATES

Stephen Grubits & Associates Pty Ltd  
Suite 5A, Level 4, 189 Kent Street, Sydney NSW 2000  
PO Box N522, Grosvenor Place NSW 1220  
Tel: +61 2 9247 1444 Fax: +61 2 9247 1499  
Email: sydney@grubits.com.au  
ABN: 24 075 049 688

File: 2013/277.65 R2.2 **ASSESSMENT SUMMARY**

<b>Product Name</b>	CSR Rediwall®
<b>Manufacturer</b>	AFS Walling Solutions, a division of CSR Ltd
<b>Assessment Reports</b>	Stephen Grubits & Associates, Fire Engineering Report 2013/277.65 R1.4, Issued 01 July 2020
<b>Applicable Building Code</b>	National Construction Code 2019 Amendment 1 Building Code of Australia (BCA), Volume One
<b>Relevant BCA Performance Requirements</b>	CP1 and CP2
<b>Purpose of this document</b>	To summarise findings of SGA Report Number 2013/277.65 R1.4
<b>Date of Issue:</b>	01/07/2020
<b>Date of Expiry</b>	Date NCC 2019 Amendment 1 is amended or superseded

### Overview

The fire-resisting performance of the above-mentioned product was assessed by Stephen Grubits & Associates (SGA) at the request of AFS Walling Solutions, a division of CSR Ltd. The fire-resistance level achieved by 110 mm thick CSR Rediwall® walls was evaluated based on test data relating to 150 mm thick and 200 mm thick CSR Rediwall® (see limitations). The findings were applicable to 110 mm thick CSR Rediwall® of the following dimensions

- 2.7 m floor-to-floor wall height, restrained such that the  $k$  factor (in accordance with AS 3600-2018) is no greater than 0.75.
- 2.9 m floor-to-floor wall height, restrained such that the  $k$  factor is no greater than 0.75.
- 2.2 m floor-to-floor wall height, restrained such that the  $k$  factor is no greater than 1.

### Assumptions and Limitations

The assessment is strictly limited to 110 mm thick CSR Rediwall® with the following characteristics:

- One layer of N12 steel reinforcing bars located in the centre of the wall thickness at 350 mm centres vertically and 400 mm centres horizontally
- Rediwall® to be arranged such that its plastic webs are in a vertical arrangement only.
- The FRLs described in this document are valid for exposure to fire on one-side only.

Issued by:	Carlos Quaglia (C10 - BPB0334)		Approved by:	Rose Pengilly (Director)	
------------	-----------------------------------	--	--------------	-----------------------------	--



# Fire-resistance test on services penetrating vertical separating elements

## Test Report

**Author:** Chris Wojcik  
**Report number:** FSV 2094  
**Date:** 21 May 2020

**Client:** AFS Systems Pty Ltd

Commercial-in-confidence

EXAMPLE



NATA Accredited Laboratory  
 Number: 165  
 Corporate Site No 3625  
 Accredited for compliance with ISO/IEC 17025 - Testing



# The fire resistance of AFS Rediwall and AFS Logicwall including various service penetrations in accordance with AS 1530.4 – 2014 and AS 4072.1 – 2005 Amdt 1

## Assessment Report

**Author:** Keith Nicholls

**Assessment Number:** FCO-3380 Rev B

**Quote Number:** CO5209

**Date:** 8<sup>th</sup> July 2020

**The Client:** AFS Systems Pty Ltd

Commercial-in-confidence



## STEPHEN GRUBITS & ASSOCIATES

Stephen Grubits & Associates Pty Ltd  
 ABN 24 075 049 688  
 PO Box N522, Grosvenor Place NSW 1220  
 T: +61 2 9247 1444 E: sydney@grubits.com.au W: www.grubits.com.au

SAMPLE

### Rediwall® CodeMark Certification

FOR CODEMARK EVALUATION

REPORT 2013/277.78 R1.6

• FIRE SAFETY ENGINEERS •

SAMPLE

**EXOVd**  
Warringtonfire**TEST REPORT**

External Wall reaction to fire testing of a  
110mm thick external wall system in  
accordance with AS5113: 2016.

**EWFA Report No:**

51713900.1

**Report Sponsor:**

AFS Systems Pty Ltd  
110 Airds Road  
Minto NSW 2566

**Test Date:**

17 October 2017

Testing, Calibrating, Advising

warringtonfire  
Proud to be part of  element



## Classification report

Classification of wall and ceiling lining in accordance with  
AS 5637.1:2015

Test sponsor: AFS Systems Pty Ltd

Product: Concrete-filled AFS rediwall, PVC reference No: RE05D02DB

Report number: ASCRRTF190226

Test date: 25 November 2019 Revision: R2.0

## Rediwall® AS1530.3 Fire Hazard Properties Test Report

## AWTA PRODUCT TESTING

Australian Wool Testing Authority Ltd - trading as AWTA Product Testing  
 A.B.N 43 006 014 106  
 1st Floor, 191 Racecourse Road, Flemington, Victoria 3031  
 P.O Box 240, North Melbourne, Victoria 3051  
 Phone (03) 9371 2400 Fax (03) 9371 2499

## TEST REPORT

**Client :** CSR - AFS Walling Solutions  
 110 Airds Road  
 Minto NSW 2566

**Test Number :** 17-003237  
**Issue Date :** 21/06/2017  
**Print Date :** 28/06/2017

**Sample Description** Clients Ref : "Rediwall"  
 Walling system with PVC facing  
 Nominal Composition : PVC/Concrete  
 Nominal Mass per Unit Area/Density : Approx. 450kg/m2  
 Nominal Thickness : Approx. 60mm

AS/NZS 1530.3-1999

**Methods for Fire Tests on Building Materials, Components and Structures  
 Part 3: Simultaneous Determination of Ignitability,  
 Flame Propagation, Heat Release and Smoke Release**

Face tested:	Face	
Date tested:	21/06/2017	
	Standard Error	Mean
Ignition time	0.43	10.35 min
Flame propagation time	Nil	Nil sec
Heat release integral	2.2	16.8 kJ/m <sup>2</sup>
Smoke release, log d	0.0400	-0.4439
Optical density, d		0.3670 / metre
Number of specimens ignited:		6
Number of specimens tested:		6
Regulatory Indices:		
Ignitability Index		10 Range 0-20
Spread of Flame Index		0 Range 0-10
Heat Evolved Index		0 Range 0-10
Smoke Developed Index		6 Range 0-10

96083

20342

Page 1 of 2

© Australian Wool testing Authority Ltd  
 Copyright - All Rights Reserved



Accredited for compliance with ISO/IEC 17025  
 - Chemical Testing  
 - Mechanical Testing  
 - Performance & Approvals Testing

: Accreditation No. 983  
 : Accreditation No. 985  
 : Accreditation No. 1356



Samples and their identifying descriptions have been provided by the client unless otherwise stated. AWTA Ltd makes no warranty, implied or otherwise, as to the source of the tested samples. The above test results relate only to the sample or samples tested. This document shall not be reproduced except in full and shall be rendered void if amended or altered. This document, the names AWTA Product Testing and AWTA Ltd may be used in advertising providing the content and format of the advertisement have been approved by the Managing Director of AWTA Ltd.

0204/11/06

APPROVED SIGNATORY

MICHAEL A. JACKSON B.Sc.1-016:  
 MANAGING DIRECTOR





**DIRECTORS**  
 MATTHEW PALAVIDIS  
 VICTOR FATTORETTO  
 MATTHEW SHIELDS

20181292.1/1801A/R2/JL

18/01/2019

CSR - AFS Walling Solutions  
 110 Airs Road  
 MINTO NSW 2566

### AFS Rediwall 110mm Base Wall - Acoustic Performance Opinion - AFS6001

This letter presents the professional acoustic assessment of Acoustic Logic Consultancy (ALC) in relation to the following AFS wall system:

- AFS Rediwall 110mm Base Wall

$R_w$ : Weighted Sound Reduction Index which is calculated using the third octave frequency bands between and including 100 Hz to 3150 Hz.

$D_{nTw}$ : Weighted Standardised Level Difference which is calculated using the third octave frequency bands between and including 100 Hz to 3150 Hz.

$C_{tr}$ : Spectrum adaptation term.

It is the opinion of ALC that this construction will achieve the acoustic rating presented in the table below:

**Table 1 – Predicted Acoustic Rating**

Predicted $R_w$	Predicted $C_{tr}$	Predicted $R_w + C_{tr}$
50	-5	45

SYDNEY  
 A: 9 Sarah St  
 MASCOT 2020  
 T: (02) 8339 8000

SYDNEY MELBOURNE BRISBANE CANBERRA  
 LONDON DUBAI SINGAPORE GREECE

ABN: 11 068 954 343

The information in this document is the property of Acoustic Logic Consultancy Pty Ltd ABN 11 068 954 343 and shall be returned on demand. It is issued on the condition that, except with our written permission, it must not be reproduced, copied or communicated to any other party nor be used for any purpose other than that stated in particular enquiry, order or contract with which it is issued.

I:\Jobs\2018\20181292\20181292.1\20190118JLA\_R2\_Acoustic Performance Opinion - AFS6001.docx



**DIRECTORS**  
 MATTHEW PALAVIDIS  
 VICTOR FATTORETTO  
 MATTHEW SHIELDS

20181292.1/1801A/R0/JL

18/01/2019

CSR - AFS Walling Solutions  
 110 Airds Road  
 MINTO NSW 2566

### **AFS Rediwall 156mm Base Wall - Acoustic Performance Opinion - AFS7001**

This letter presents the professional acoustic assessment of Acoustic Logic Consultancy (ALC) in relation to the following AFS wall system:

- AFS Rediwall 156mm Base Wall

$R_w$ : Weighted Sound Reduction Index which is calculated using the third octave frequency bands between and including 100 Hz to 3150 Hz.

$D_{nT_w}$ : Weighted Standardised Level Difference which is calculated using the third octave frequency bands between and including 100 Hz to 3150 Hz.

$C_{tr}$ : Spectrum adaptation term.

It is the opinion of ALC that this construction will achieve the acoustic rating presented in the table below:

**Table 1 – Predicted Acoustic Rating**

Predicted $R_w$	Predicted $C_{tr}$	Predicted $R_w + C_{tr}$
54	-4	50

SYDNEY  
 A: 9 Sarah St  
 MASCOT 2020  
 T: (02) 8339 8000

SYDNEY MELBOURNE BRISBANE CANBERRA  
 LONDON DUBAI SINGAPORE GREECE

ABN: 11 068 954 343

The information in this document is the property of Acoustic Logic Consultancy Pty Ltd ABN 11 068 954 343 and shall be returned on demand. It is issued on the condition that, except with our written permission, it must not be reproduced, copied or communicated to any other party nor be used for any purpose other than that stated in particular enquiry, order or contract with which it is issued.

I:\Jobs\2018\20181292\20181292.1\20190118JLA\_R0\_Acoustic Performance Opinion - AFS7001.docx



**DIRECTORS**  
 MATTHEW PALAVIDIS  
 VICTOR FATTORETTO  
 MATTHEW SHIELDS

20181292.1/1801A/R0/JL

18/01/2019

CSR - AFS Walling Solutions  
 110 Airds Road  
 MINTO NSW 2566

### **AFS Rediwall 200mm Base Wall - Acoustic Performance Opinion - AFS8001**

This letter presents the professional acoustic assessment of Acoustic Logic Consultancy (ALC) in relation to the following AFS wall system:

- AFS Rediwall 200mm Base Wall

$R_w$ : Weighted Sound Reduction Index which is calculated using the third octave frequency bands between and including 100 Hz to 3150 Hz.

$D_{nT_w}$ : Weighted Standardised Level Difference which is calculated using the third octave frequency bands between and including 100 Hz to 3150 Hz.

$C_{tr}$ : Spectrum adaptation term.

It is the opinion of ALC that this construction will achieve the acoustic rating presented in the table below:

**Table 1 – Predicted Acoustic Rating**

Predicted $R_w$	Predicted $C_{tr}$	Predicted $R_w + C_{tr}$
58	-5	53

SYDNEY  
 A: 9 Sarah St  
 MASCOT 2020  
 T: (02) 8339 8000

SYDNEY MELBOURNE BRISBANE CANBERRA  
 LONDON DUBAI SINGAPORE GREECE

ABN: 11 068 954 343

The information in this document is the property of Acoustic Logic Consultancy Pty Ltd ABN 11 068 954 343 and shall be returned on demand. It is issued on the condition that, except with our written permission, it must not be reproduced, copied or communicated to any other party nor be used for any purpose other than that stated in particular enquiry, order or contract with which it is issued.

I:\Jobs\2018\20181292\20181292.1\20190118JLA\_R0\_Acoustic Performance Opinion - AFS8001.docx



**DIRECTORS**  
 MATTHEW PALAVIDIS  
 VICTOR FATTORETTO  
 MATTHEW SHIELDS

20181292.1/1801A/R0/JL

18/01/2019

CSR - AFS Walling Solutions  
 110 Airds Road  
 MINTO NSW 2566

### **AFS Rediwall 256mm Base Wall - Acoustic Performance Opinion - AFS9001**

This letter presents the professional acoustic assessment of Acoustic Logic Consultancy (ALC) in relation to the following AFS wall system:

- AFS Rediwall 256mm Base Wall

$R_w$ : Weighted Sound Reduction Index which is calculated using the third octave frequency bands between and including 100 Hz to 3150 Hz.

$D_{nT_w}$ : Weighted Standardised Level Difference which is calculated using the third octave frequency bands between and including 100 Hz to 3150 Hz.

$C_{tr}$ : Spectrum adaptation term.

It is the opinion of ALC that this construction will achieve the acoustic rating presented in the table below:

**Table 1 – Predicted Acoustic Rating**

Predicted $R_w$	Predicted $C_{tr}$	Predicted $R_w + C_{tr}$
60	-5	55

SYDNEY  
 A: 9 Sarah St  
 MASCOT 2020  
 T: (02) 8339 8000

SYDNEY MELBOURNE BRISBANE CANBERRA  
 LONDON DUBAI SINGAPORE GREECE

ABN: 11 068 954 343

The information in this document is the property of Acoustic Logic Consultancy Pty Ltd ABN 11 068 954 343 and shall be returned on demand. It is issued on the condition that, except with our written permission, it must not be reproduced, copied or communicated to any other party nor be used for any purpose other than that stated in particular enquiry, order or contract with which it is issued.

I:\Jobs\2018\20181292\20181292.1\20190118JLA\_R0\_Acoustic Performance Opinion - AFS9001.docx



**DIRECTORS**  
 MATTHEW PALAVIDIS  
 VICTOR FATTORETTO  
 MATTHEW SHIELDS

20181292.5/2004A/R1/GW

20/04/2020

CSR - AFS Walling Solutions  
 110 Airds Road  
 MINTO NSW 2566

### 275MM THICK AFS REDIWALL - ACOUSTIC ASSESSMENT

This letter presents the professional acoustic assessment of Acoustic Logic Consultancy (ALC) in relation to the following AFS wall system:

- AFS Rediwall 275mm Base Wall

$R_w$ : Weighted Sound Reduction Index which is calculated using the third octave frequency bands between and including 100 Hz to 3150 Hz.

$D_{nTw}$ : Weighted Standardised Level Difference which is calculated using the third octave frequency bands between and including 100 Hz to 3150 Hz.

$C_{tr}$ : Spectrum adaptation term.

It is the opinion of ALC that this construction will achieve the acoustic rating presented in the table below:

**Table 1 – Predicted Acoustic Rating**

Wall	Predicted $R_w$	Predicted $C_{tr}$	Predicted $R_w + C_{tr}$
AFS 275mm Rediwall	61	-5	56

SYDNEY  
 A: 9 Sarah St  
 MASCOT 2020  
 T: (02) 8339 8000

SYDNEY MELBOURNE BRISBANE CANBERRA  
 LONDON DUBAI SINGAPORE GREECE

ABN: 11 068 954 343

The information in this document is the property of Acoustic Logic Consultancy Pty Ltd ABN 11 068 954 343 and shall be returned on demand. It is issued on the condition that, except with our written permission, it must not be reproduced, copied or communicated to any other party nor be used for any purpose other than that stated in particular enquiry, order or contract with which it is issued.

I:\Jobs\2018\20181292\20181292.5\20200420GWA\_R1\_Acoustic Assessment.docx



**DIRECTORS**  
 MATTHEW PALAVIDIS  
 VICTOR FATTORETTO  
 MATTHEW SHIELDS

20181292.5/2004A/R2/GW

20/04/2020

CSR - AFS Walling Solutions  
 110 Airds Road  
 MINTO NSW 2566

### 300MM THICK AFS REDIWALL - ACOUSTIC ASSESSMENT

This letter presents the professional acoustic assessment of Acoustic Logic Consultancy (ALC) in relation to the following AFS wall system:

- AFS Rediwall 300mm Base Wall

$R_w$ : Weighted Sound Reduction Index which is calculated using the third octave frequency bands between and including 100 Hz to 3150 Hz.

$D_{nTw}$ : Weighted Standardised Level Difference which is calculated using the third octave frequency bands between and including 100 Hz to 3150 Hz.

$C_{tr}$ : Spectrum adaptation term.

It is the opinion of ALC that this construction will achieve the acoustic rating presented in the table below:

**Table 1 – Predicted Acoustic Rating**

Wall	Predicted $R_w$	Predicted $C_{tr}$	Predicted $R_w + C_{tr}$
AFS 300mm Rediwall	61	-5	56

SYDNEY  
 A: 9 Sarah St  
 MASCOT 2020  
 T: (02) 8339 8000

SYDNEY MELBOURNE BRISBANE CANBERRA  
 LONDON DUBAI SINGAPORE GREECE

ABN: 11 068 954 343

The information in this document is the property of Acoustic Logic Consultancy Pty Ltd ABN 11 068 954 343 and shall be returned on demand. It is issued on the condition that, except with our written permission, it must not be reproduced, copied or communicated to any other party nor be used for any purpose other than that stated in particular enquiry, order or contract with which it is issued.

I:\Jobs\2018\20181292\20181292.5\20200420GWA\_R2\_Acoustic Assessment.docx

**OVERALL “TOTAL R” (THERMALLY BRIDGED)  
THERMAL PERFORMANCE CALCULATIONS  
TO AS/NZS 4859 Parts 1 & 2:2018**

The following calculations by James M Fricker Pty Ltd are based upon:

- a) AS/NZS 4859.1:2018 “Thermal insulation materials for buildings. Part 1: General criteria and technical provisions”,
- b) AS/NZS 4859.2:2018 “Thermal insulation materials for buildings. Part 2: Design”,
- c) the Australian Institute of Refrigeration Air-conditioning & Heating (AIRAH) Handbook (Edition 5, 2013), and (if necessary) the ASHRAE Fundamentals Handbook.

Initial results report Total R for each thermal path. These results are combined by area weighting and isothermal planes method to deduce **Overall Surface Total R**. This is per AS/NZS 4859.2:2018 Clause 4.3 – “A total resistance associated with a construction of materials, computed or measured over an area sufficient to be fully representative of the element of construction, and specified as a Total R-value, including surface film resistances and thermal bridging.”

Total R-values are based on product in-service conditions in accordance with AS/NZS 4859.2:2018 including the alteration of insulation Material R for temperature, and Air Space R for temperature and infrared emittance.

Each calculation result is subject to any specific notes and assumptions listed on the calculation.

If a construction differs from the described system, the thermal resistance may be different.

All calculations were done by James M Fricker, F.AIRAH F.IEAust CPEng NER APEC Engineer IntPE(Aus)



**ENGINEERS  
AUSTRALIA**  
Chartered Professional Engineer  
MEMBER 1179647



**JAMES M FRICKER** PTY LTD  
54 Felix Crescent  
Ringwood North VIC 3134 Australia  
Mobile: 0414 804 097  
Phone: (03) 9879 5744  
fricker@optusnet.com.au  
<http://fricker.net.au>



# Weatherproofing Assessment

AFS Logicwall and Rediwall



NOTES:

A large rectangular area filled with a grid of small, evenly spaced dotted lines, intended for writing notes.

PVC-based permanent formwork for basements, columns, blade & party walls, lift & stair cores, retaining walls and retention tanks



**Disclaimer:** The products referred to in this document have been manufactured by or on behalf of CSR Building Products Limited ("CSR") to comply with the Building Code of Australia and any relevant Australian Standards. While any design or usage guidelines set out in this document have been prepared in good faith by CSR, they are of a general nature only and are intended to be used in conjunction with project specific design and engineering advice. It is the responsibility of the customer to ensure that CSR's products are suitable for their chosen

application, including in respect of project-specific matters such as, but not limited structural adequacy, acoustic, fire resistance/combustibility, thermal, and weatherproofing requirements. All information relating to design/installation/application of these products is offered without warranty and no responsibility can be accepted by CSR for errors and omissions, or for any use of the relevant products not in accordance with CSR's technical literature or any other relevant industry standards. For current technical and warranty documentation relating to CSR's products, visit the AFS website at [www.afsformwork.com.au](http://www.afsformwork.com.au)

(C) 2023 AFS Systems Pty Ltd ABN 455 760 727 88  
BMS1928 1023 – October 23

**afs**

[afsformwork.com.au](http://afsformwork.com.au) • 1300 727 237

AFS Systems Pty Ltd • 110 Airds Road, Minto NSW 2566

**CSR**

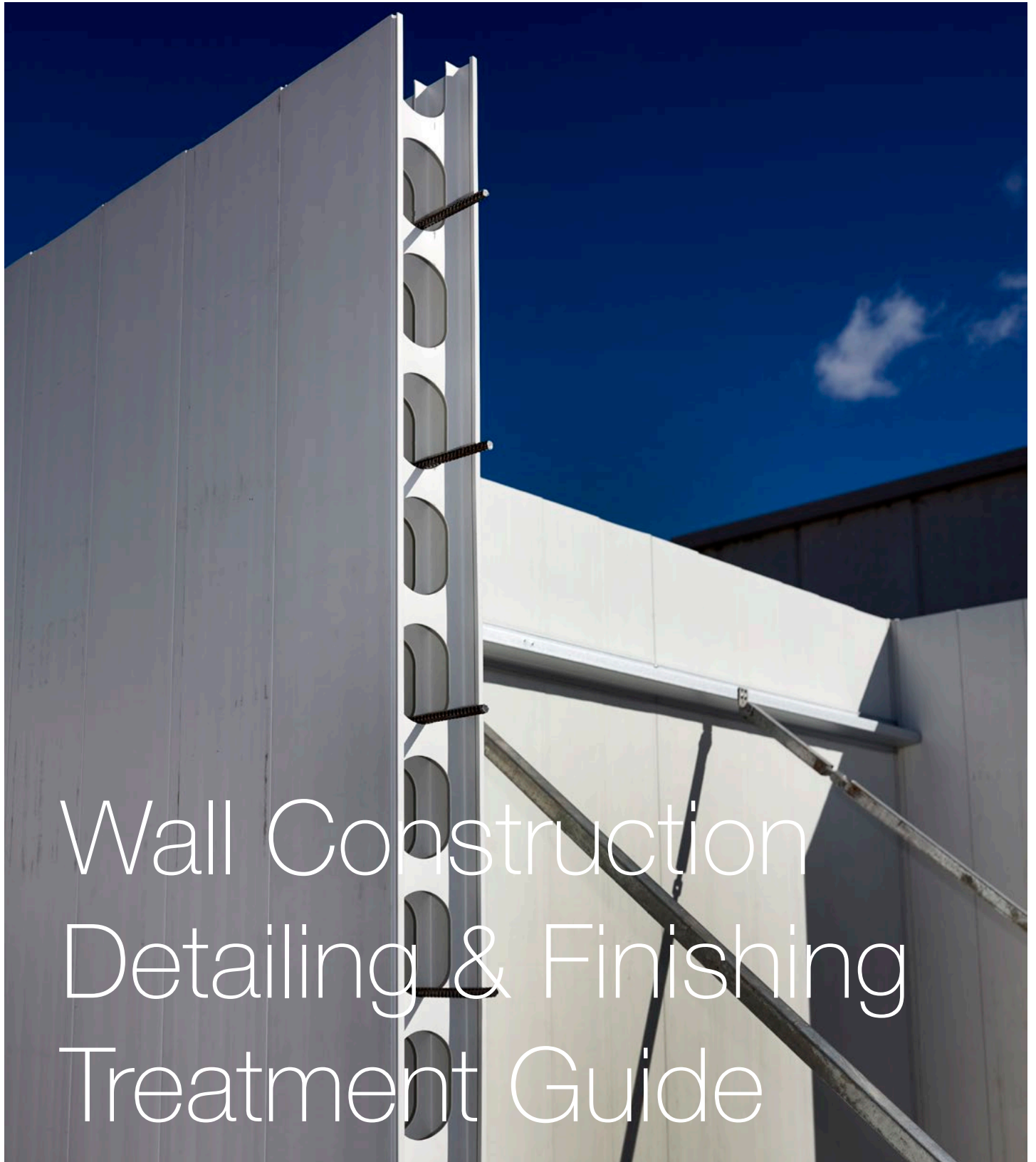

# Wall Construction Detailing & Finishing Treatment Guide

Slab Junctions, Retaining Walls, Basements & Shafts, Junctions, Openings, Terminations, Attachments and services, Finishing Treatments



# Contents

<b>Introduction</b> . . . . .	<b>4</b>
<b>Overview</b> . . . . .	<b>4</b>
<b>Construction Details</b> . . . . .	<b>5</b>
<b>Slab Junctions</b> . . . . .	<b>5</b>
Fig B1: Horizontal Joint with Rebated Slab Edge .....	5
Fig B2: Wall to Slab Junction .....	6
Fig B3: External Wall/Slab Junction at Typical Raft Slab Above Ground.....	7
Fig B4: Balcony Wall .....	8
Fig B5: Step Floor or Stair Landing Within a Fire Isolated Void.....	9
Fig B6: Junction with Post-Tensioned Slab (Internal Wall) .....	10
Fig B7: Balcony Dividing Wall .....	11
<b>Retaining Walls</b> . . . . .	<b>12</b>
Fig B8: Retaining Wall or Basement Wall to Slab Junction.....	12
Fig B9: Cantilevered Retaining Wall (maximum height 3400mm).....	13
Fig B10: Cantilevered Retaining Wall (maximum height 1800mm).....	14
<b>Basements and Shafts</b> . . . . .	<b>15</b>
Fig B11: Typical Basement .....	15
Fig B12: Typical Lift Pit.....	16
<b>Junctions</b> . . . . .	<b>17</b>
Fig B13: Corners with Squint Angles.....	17
Fig B14: Corners with Timber Formwork.....	18
Fig B15: Movement Joint – Vertical Junction .....	19
Fig B16: Double Height Wall – Horizontal Joint (2 Stage Concrete Fill).....	20
Fig B17: Junction of Rediwall® Party Wall and External Fire Rated Wall .....	21
Fig B18: Rediwall® T-Junction .....	22
Fig B19: Timber Floor Junction .....	23
Fig B20: Timber Top Plate Connection.....	24
<b>Openings &amp; Wall Terminations</b> . . . . .	<b>25</b>
Fig B21: Door Jamb Options .....	25
Fig B22: End Cap Options .....	26
Fig B23: Typical Door Opening.....	27
Fig B24: Typical Wall Penetration .....	28
Fig B25: Typical Opening in Rediwall® - Side Elevation View.....	29
Fig B26: Window Opening - Side Elevation View.....	30
<b>Attachments &amp; Services</b> . . . . .	<b>31</b>
Fig B27: Services.....	31
<b>Wall Systems</b> . . . . .	<b>32</b>
Fig B28: Typical Party Wall Detail (Continuous Construction) .....	32
Fig B29: Typical Rediwall® External Wall with Internal Plasterboard Lining on Furring Channel (Continuous Construction).....	33
Fig B30: Typical Separating Wall (Discontinuous Construction).....	34
Fig B31: Rediwall® Boundary Wall Capping (Elevation View).....	35
Fig B32: Rediwall® Boundary with Different Wall Heights .....	35

<b>Rediwall® Finishing Treatments</b> . . . . .	<b>36</b>
<b>Introduction</b> . . . . .	<b>36</b>
<b>Rediwall® Non-Combustible Compliant Finishing Treatments</b> . . . . .	<b>36</b>
Fig B33: Unclad Rediwall® With PVC Lining Left In Place – Finish Type (a) .....	37
Fig B34: Non-Combustible Cement Render (or Similar Finish) Over Rediwall® PVC Lining – Finish Type (b) .....	38
Fig B35: Plasterboard Direct Fixed To Rediwall® – Finish Type (c) .....	39
Fig B36: Plasterboard Lining and Horizontal Steel Furring Channels Fixed To Rediwall®– Finish Type (d).....	40
Fig B37: Rediwall® With Face Brick Exterior Skin – Finish Type (e).....	41
Fig B38: Tile System (<32kg/m <sup>2</sup> ) Mechanically Fixed To Rediwall® – Finish Type (f).....	42
Fig B39: Mechanically Fixed Non-Combustible Cladding To Rediwall® – Finish Type (g).....	43
Fig B40: Tile System (<32kg/m <sup>2</sup> ) Adhesive Fixed To Rediwall® – Finish Type (i).....	44
Fig B41: Adhesive Fixed Non-Combustible Cladding To Unclad Rediwall® – Finish Type (h).....	45

# Introduction

Volume 2 'Wall Construction Detailing & Finishing Treatments' forms part of a comprehensive afs rediwall® design guide which includes:

- Volume 1 – Design Performance and Compliance
- Volume 2 – Wall Construction Detailing & Finishing Treatments.
- Volume 3 – Installation Guide.

Downloads of these individual volumes are available via the Resource Centre at [www.afsformwork.com.au](http://www.afsformwork.com.au)

**Disclaimer:** This section of the afs rediwall® Design Guide is intended to represent good building practice in achieving structural design of rediwall®. This section is not intended in any way by AFS to represent all relevant information required on a project. It is the responsibility of those using and designing rediwall®, including but

not limited to builders, designers, consultants and engineers to ensure that the use of rediwall® complies with all the relevant National Construction Code (NCC) requirements such as, but not limited to structural adequacy, acoustic, fire resistance/combustibility, thermal, and weatherproofing provisions. All diagrams, plans and illustrations used in this section, including any reinforcement shown, are supplied for indicative and diagrammatic purposes only. It remains the responsibility of those using rediwall® to ensure that reference is made to the project engineer's structural details for all construction and reinforcement requirements.

## Overview

The architectural detailing and design of rediwall® for building projects requires the services of professional consultants, such as architects and engineers. This chapter has been prepared to assist consultants in project documentation and outlines a range of typical details.

Whilst examples of previously successful details are included throughout this chapter it does not replace the services of professional consultants nor is to be relied upon as a complete library of details as site conditions can vary from project to project.

### Note:

Except as noted on the following details, materials and work required are not provided by AFS or the rediwall® installation contractor.

This volume should be read in conjunction with Volume 1. Reference should be made to engineer's documentation for design details.

All details in this chapter are diagrammatic only and not drawn to scale.

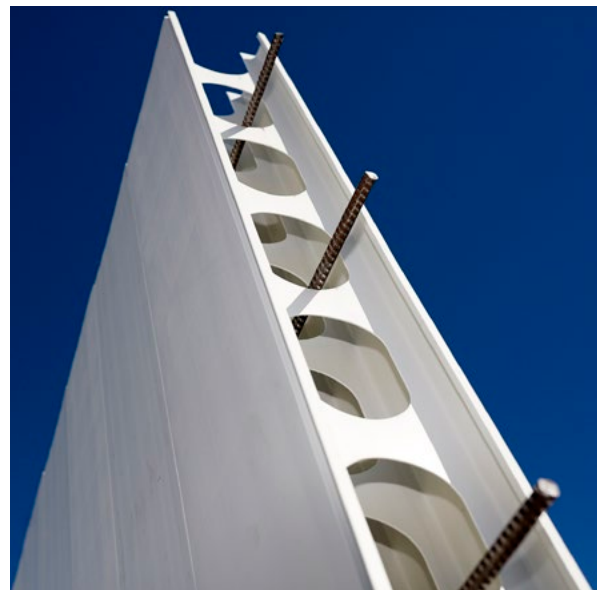

# Construction Details

Refer to Fire and Acoustic section for details on alternative finishing treatments.

The following diagrams are schematic and not necessarily to scale. They are intended to provide generic information.

## Slab Junctions

**Fig B1: Horizontal Joint with Rebated Slab Edge**

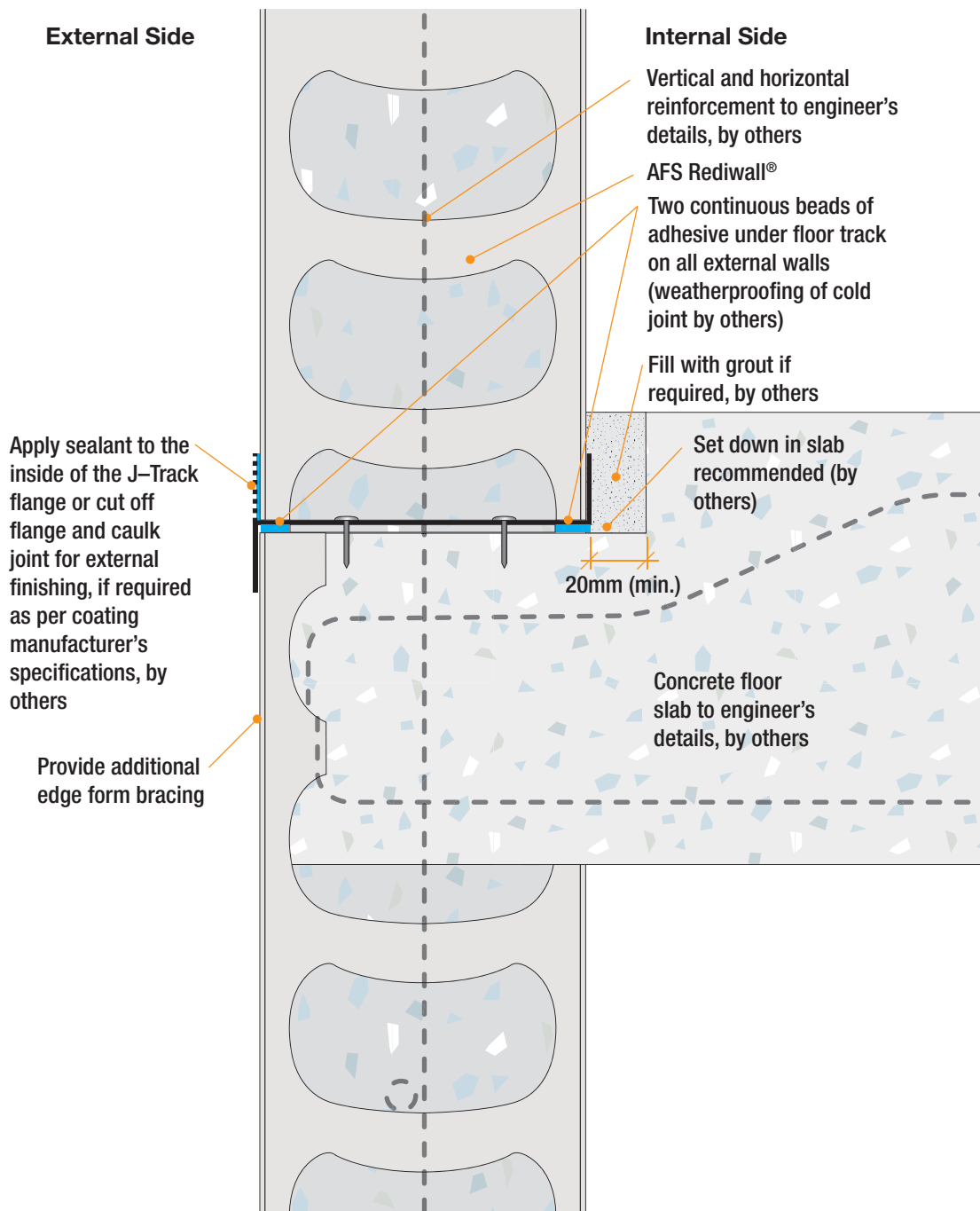

Note: Refer to "Volume 3 Installation Guide" for bracing details

Fig B2: Wall to Slab Junction

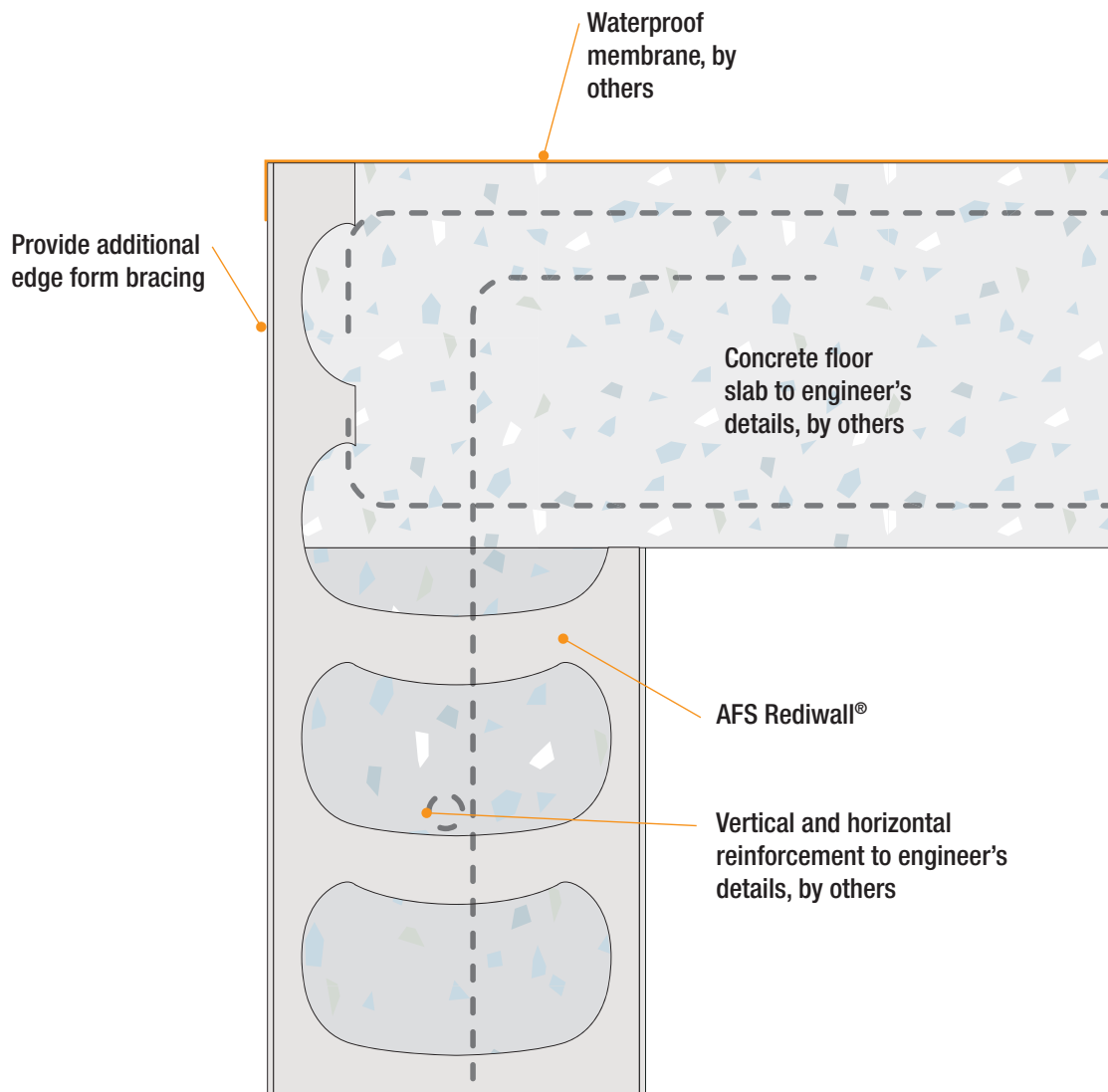

Note: Refer to "Volume 3 Installation Guide" for bracing details



Fig B3: External Wall/Slab Junction at Typical Raft Slab Above Ground

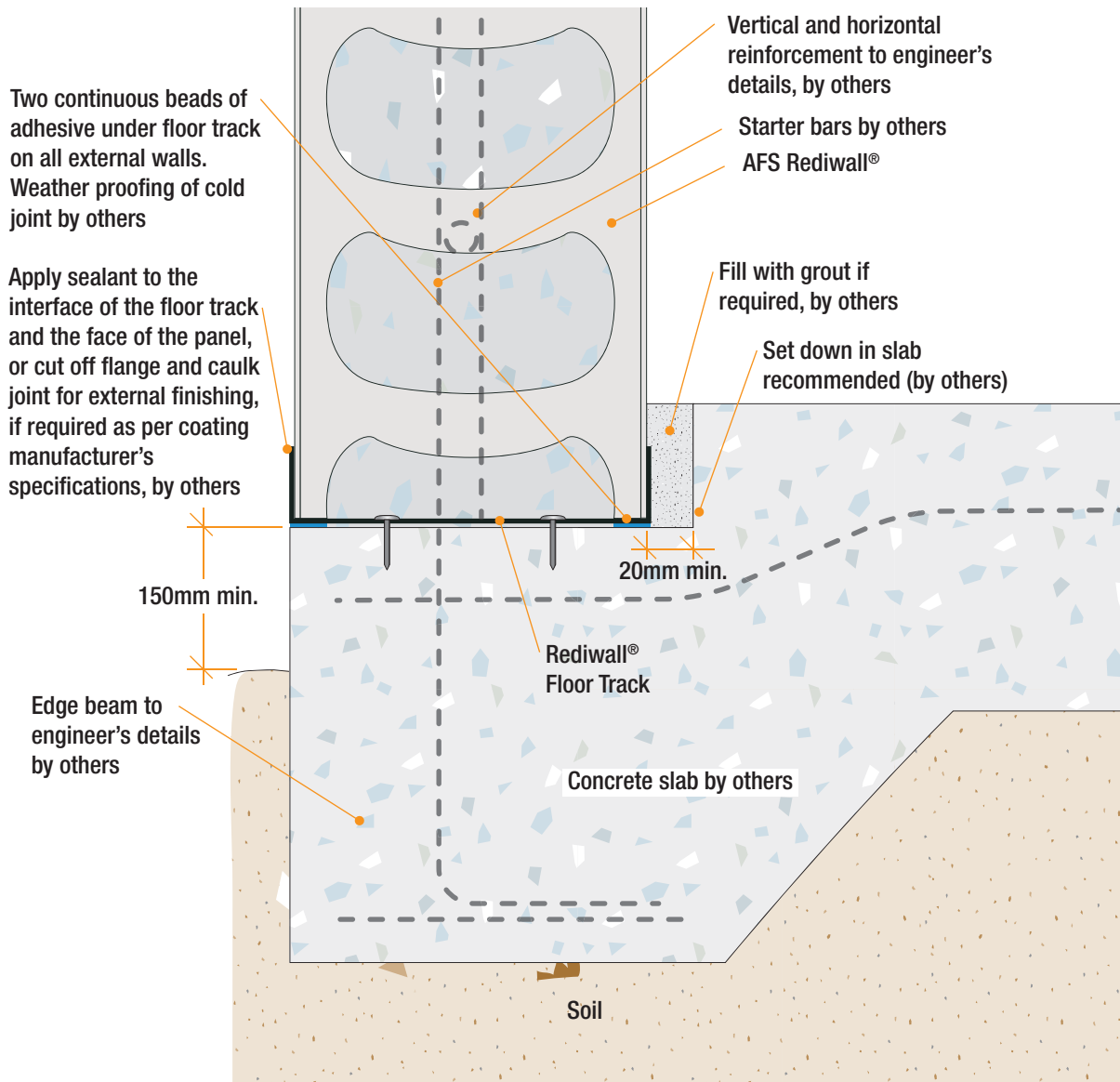

Fig B4: Balcony Wall

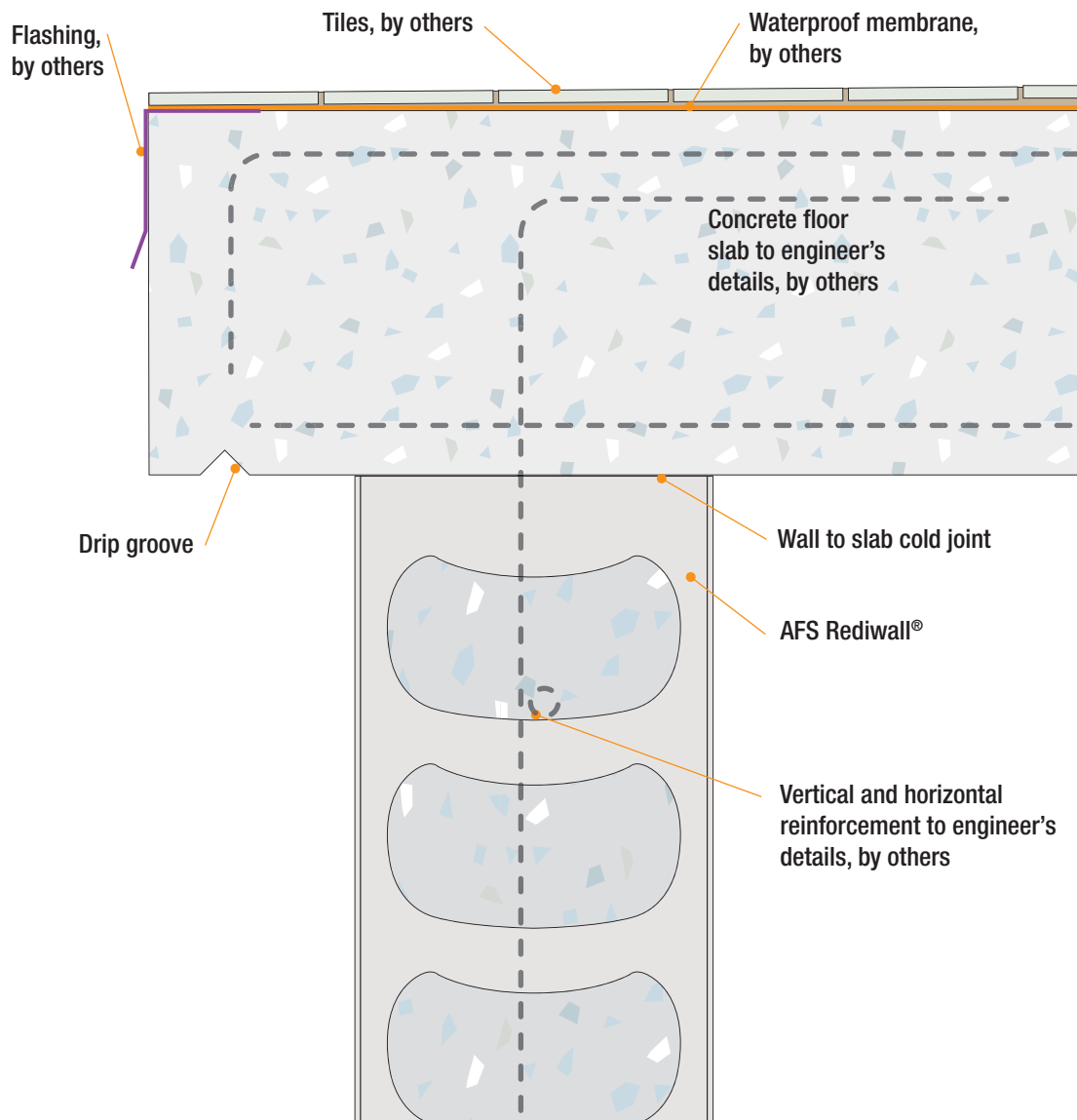

Fig B5: Step Floor or Stair Landing Within a Fire Isolated Void

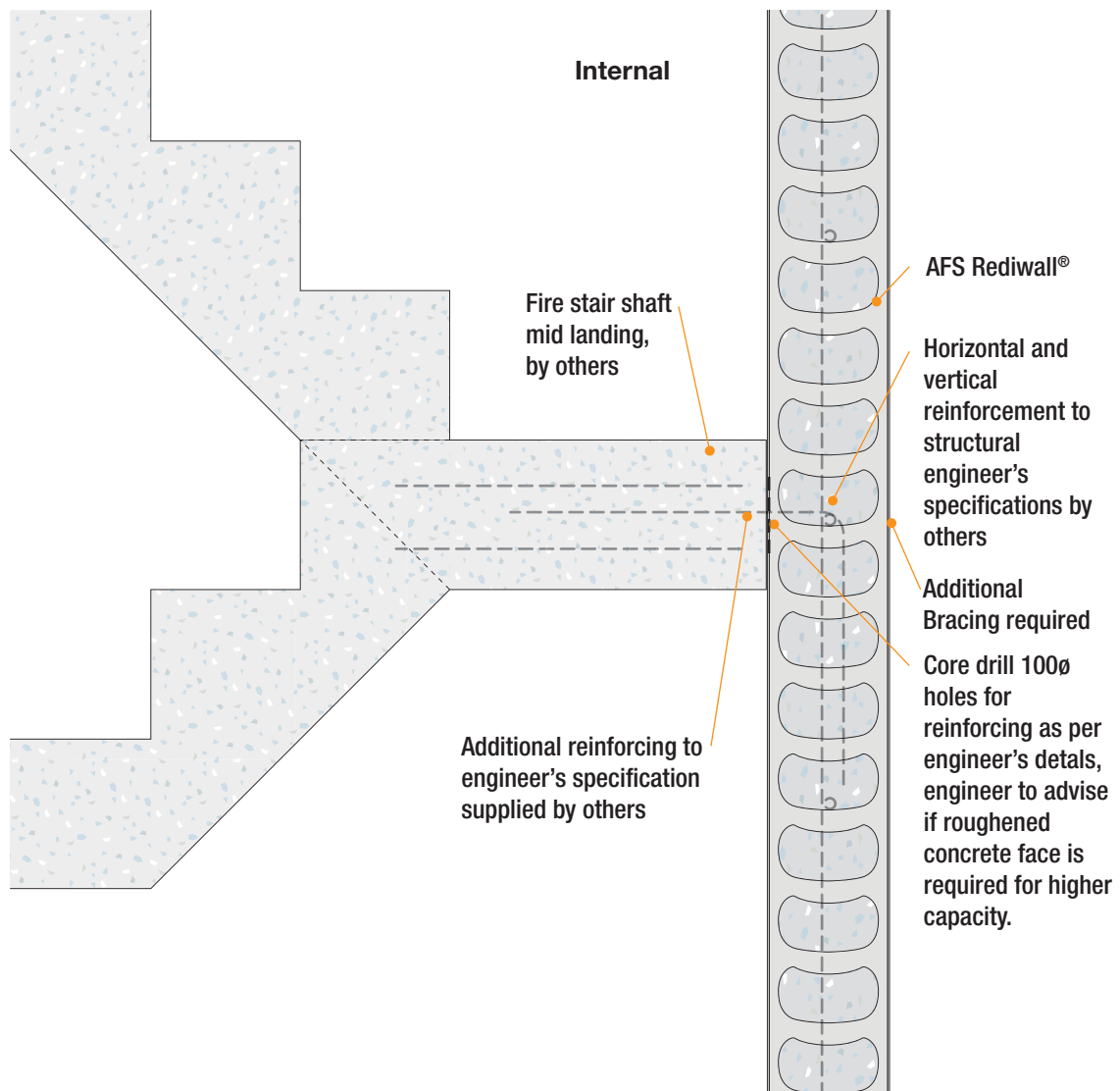

Fig B6: Junction with Post-Tensioned Slab (Internal Wall)

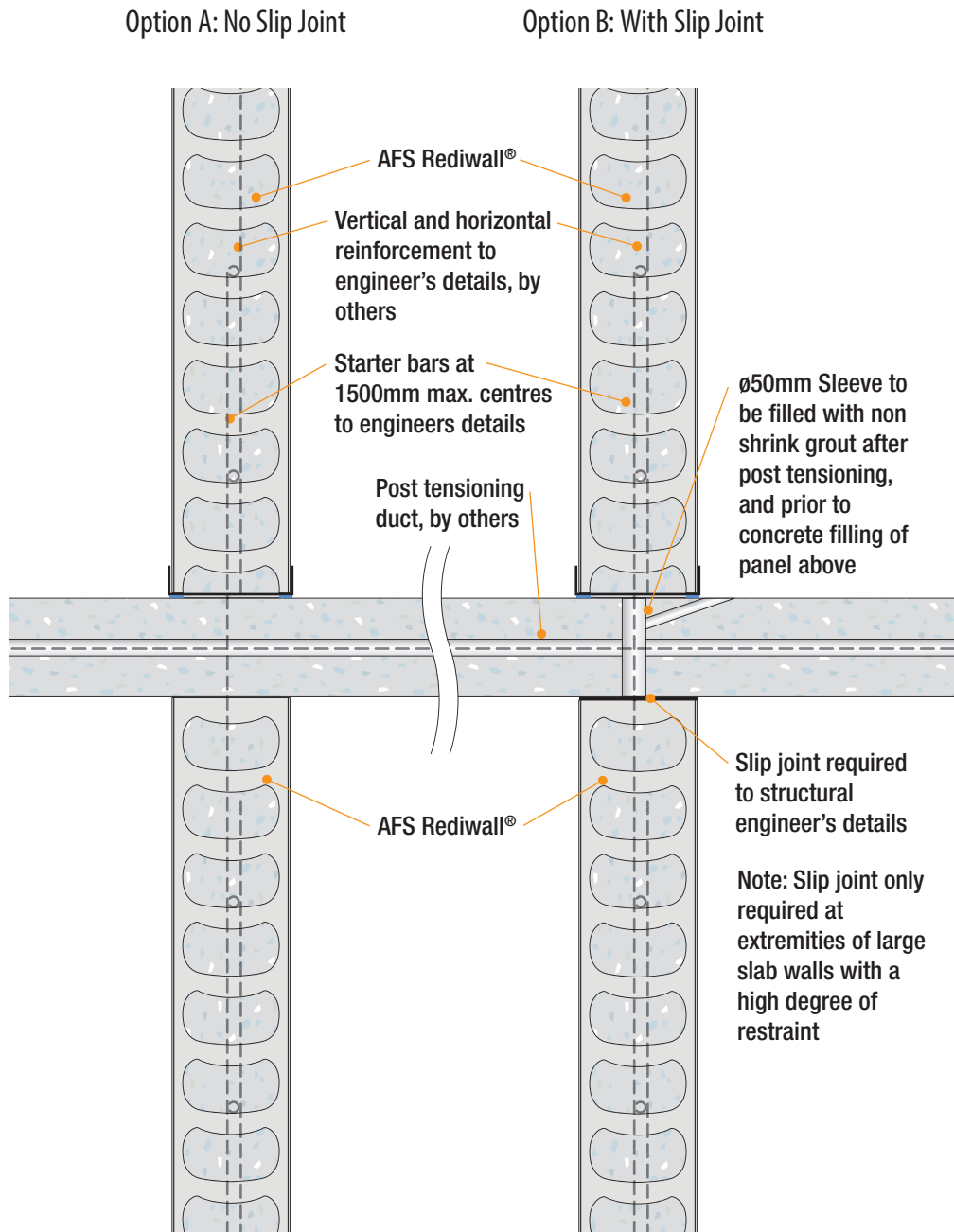
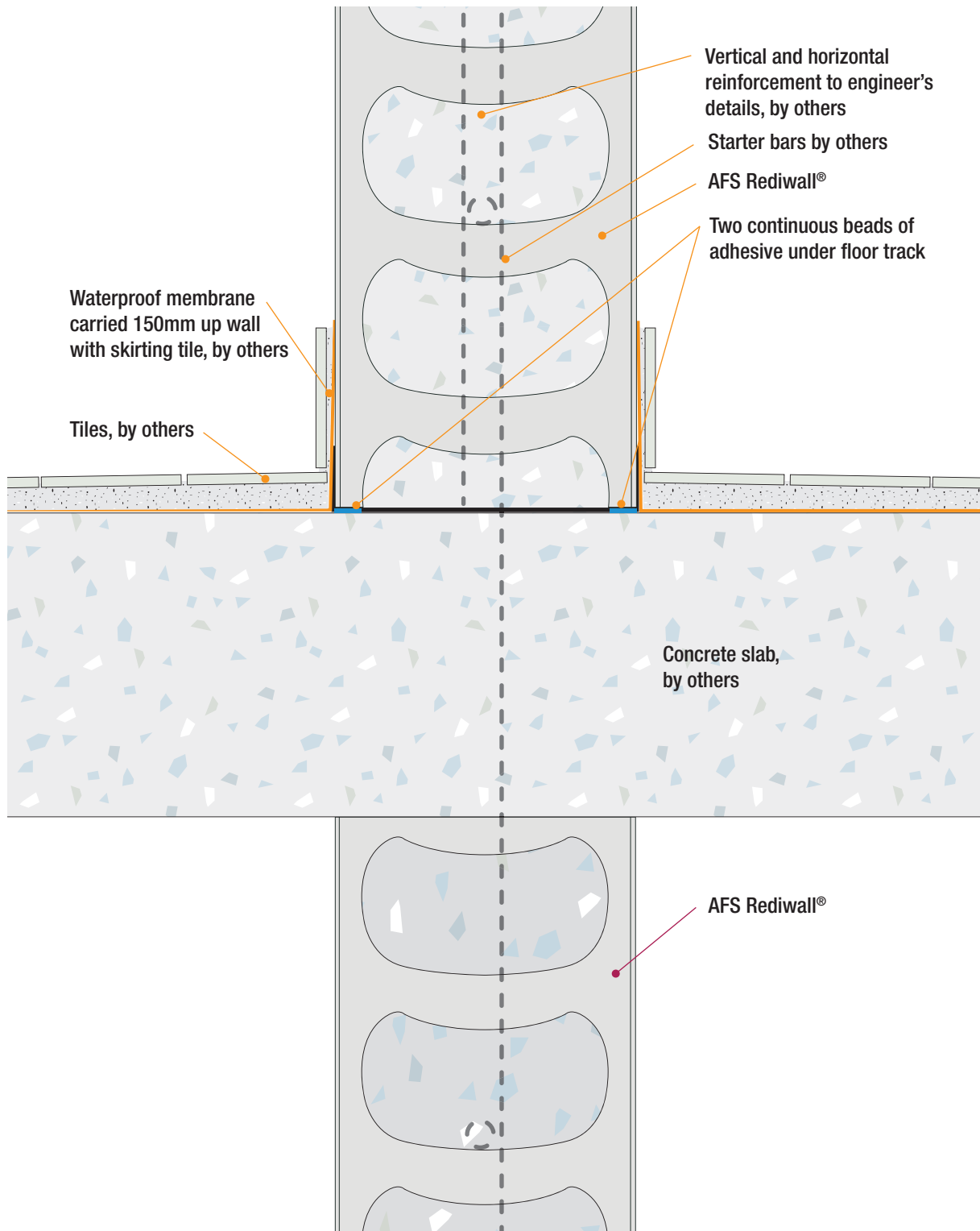

Fig B7: Balcony Dividing Wall



Retaining Walls

Fig B8: Retaining Wall or Basement Wall to Slab Junction

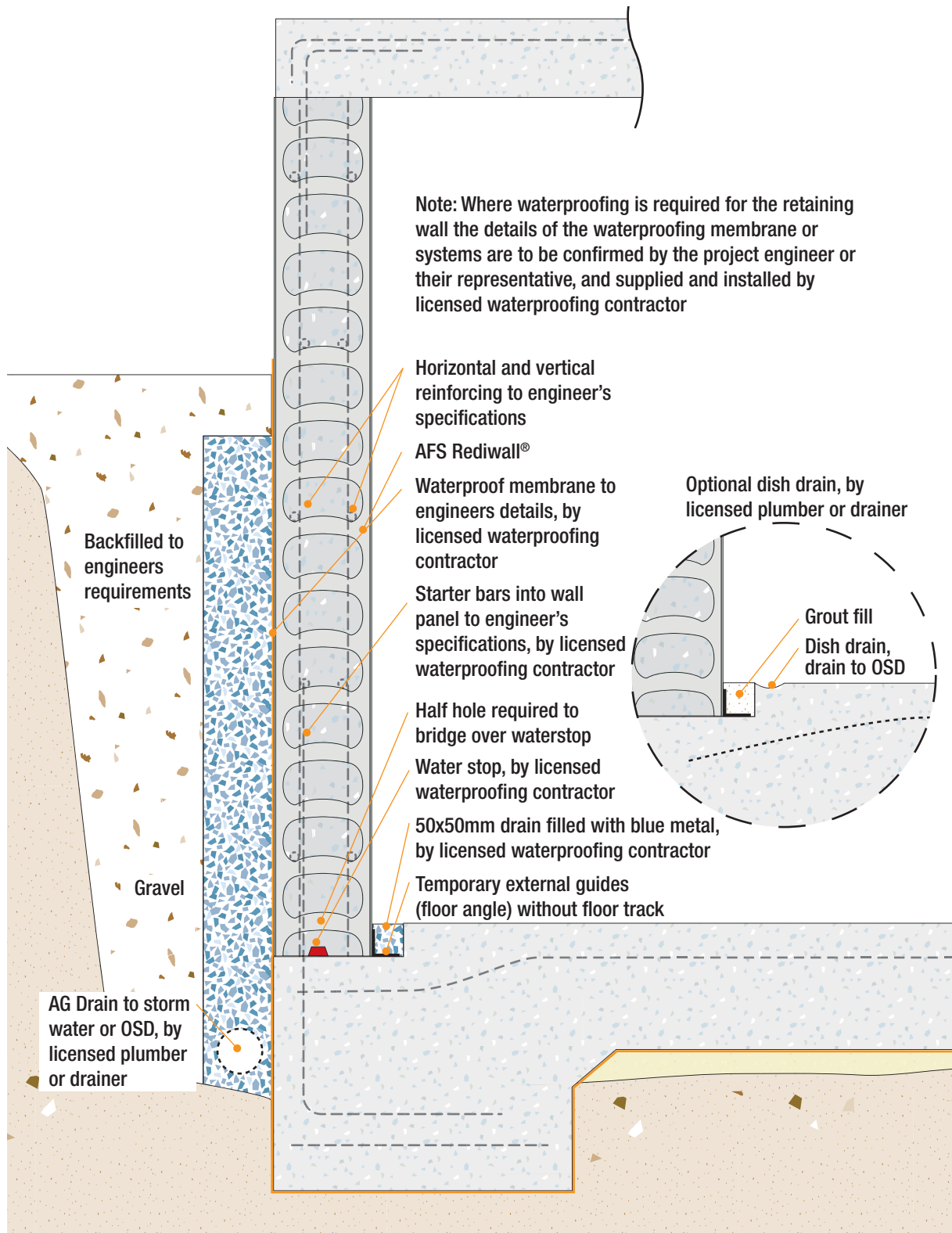

Fig B9: Cantilevered Retaining Wall (maximum height 3400mm)

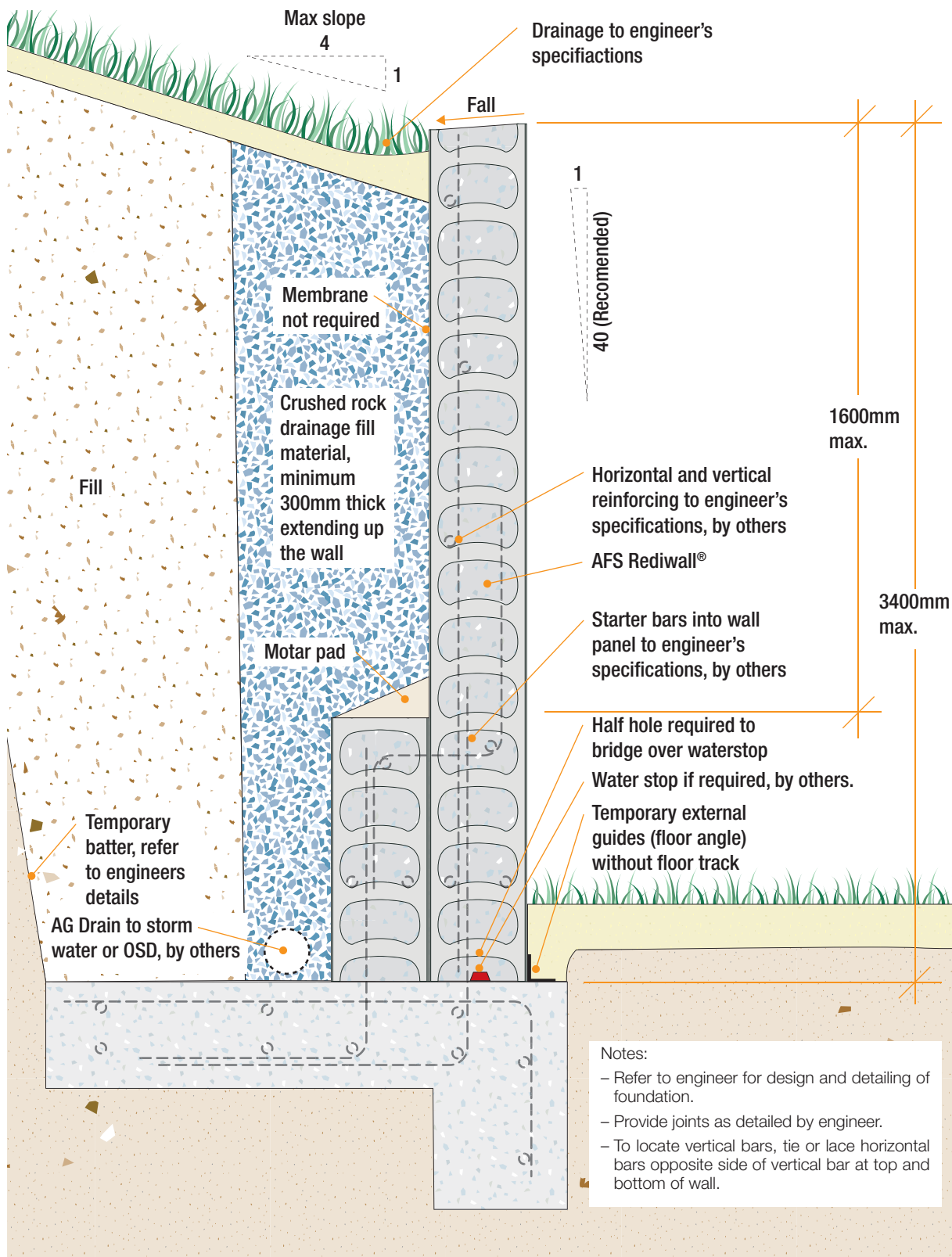
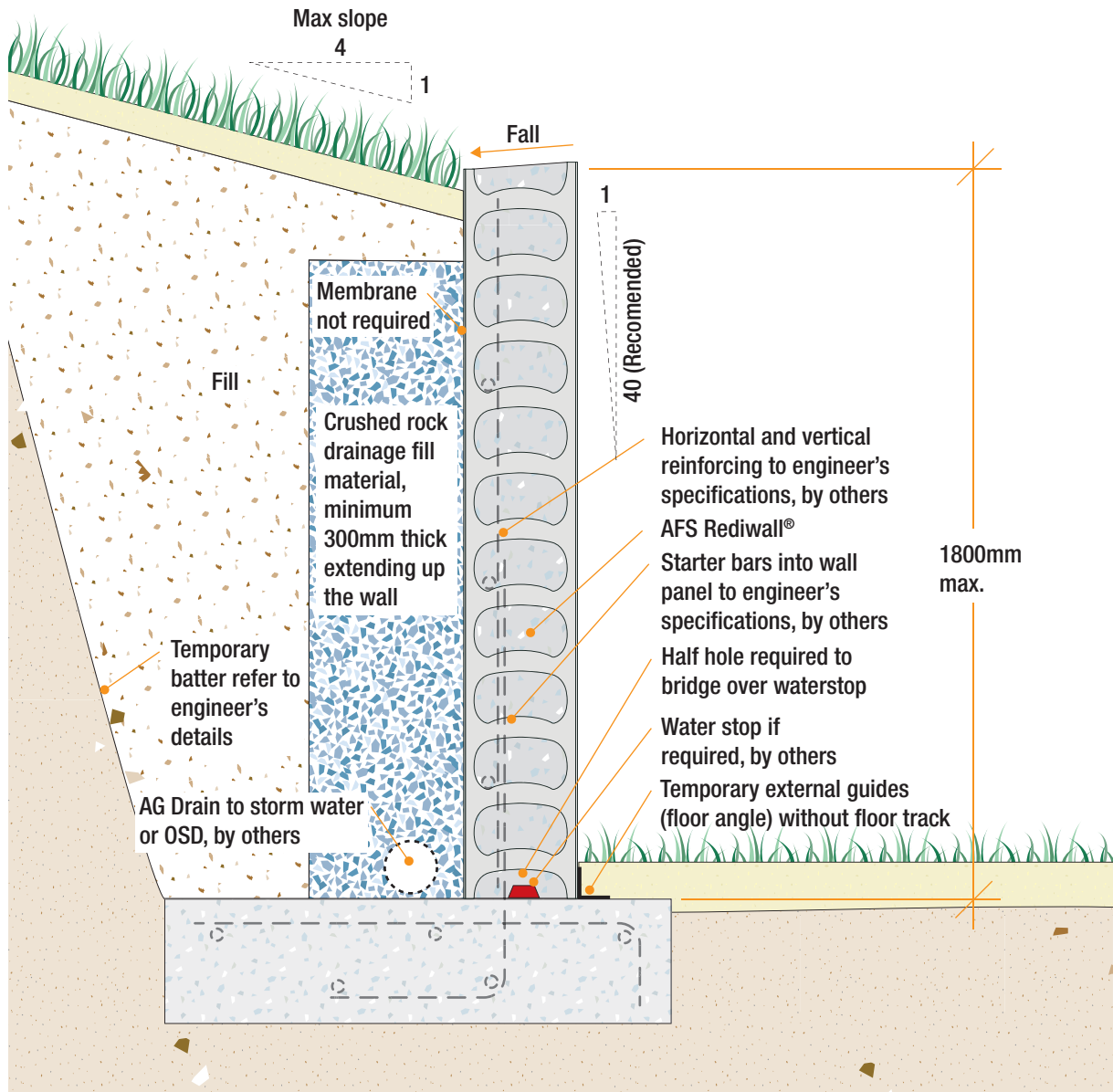

Fig B10: Cantilevered Retaining Wall (maximum height 1800mm)



Notes:

- Refer to engineer for design and detailing of foundation.
- Provide joints as detailed by engineer.
- To locate vertical bars, tie or lace horizontal bars opposite side of vertical bar at top and bottom of wall.





Fig B12: Typical Lift Pit

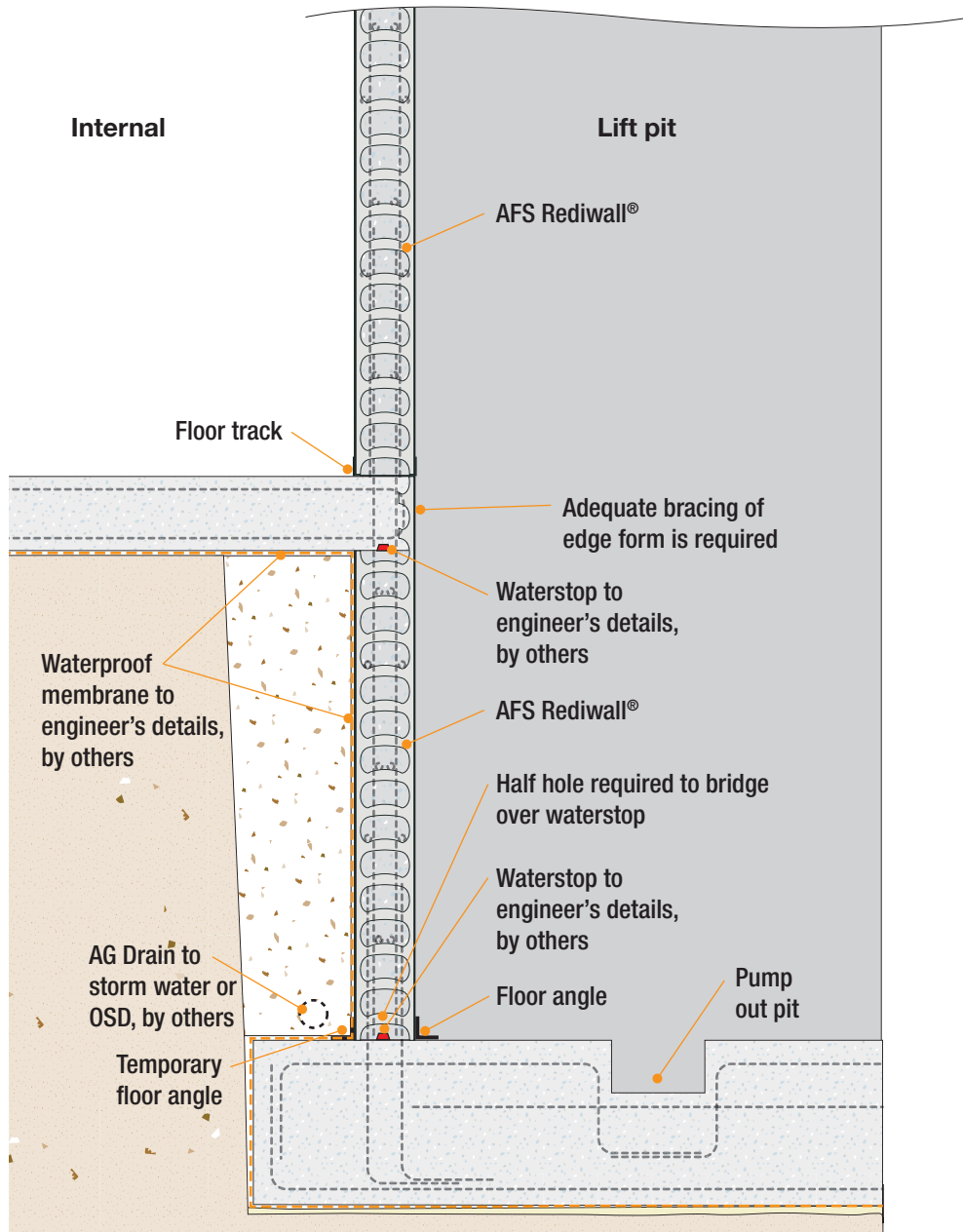

## Notes:

- Where waterproofing is required for the retaining wall the details of the waterproofing membrane or systems are to be confirmed by the project engineer or their representative, and supplied and installed by others.
- Refer to engineer for design and detailing of foundation.
- Provide joints as detailed by engineer.
- To locate vertical bars, tie or lace horizontal bars opposite side of vertical bar at top and bottom of wall.
- Refer to "Volume 3 Installation guide" for bracing details.

## Junctions

Fig B13: Corners with Squint Angles

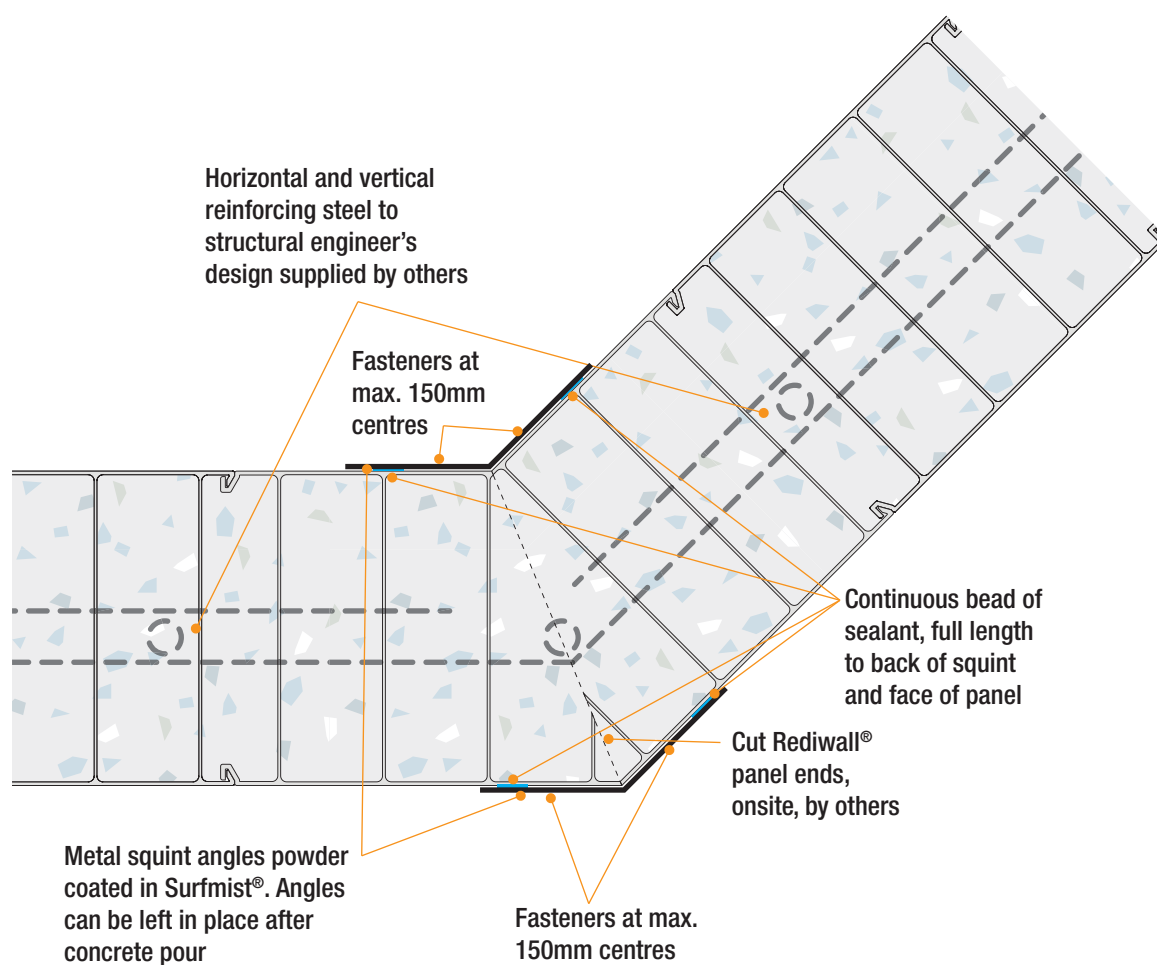

Notes:

- Refer to Volume 3 – Installation Guide for bracing details.

Fig B14: Corners with Timber Formwork

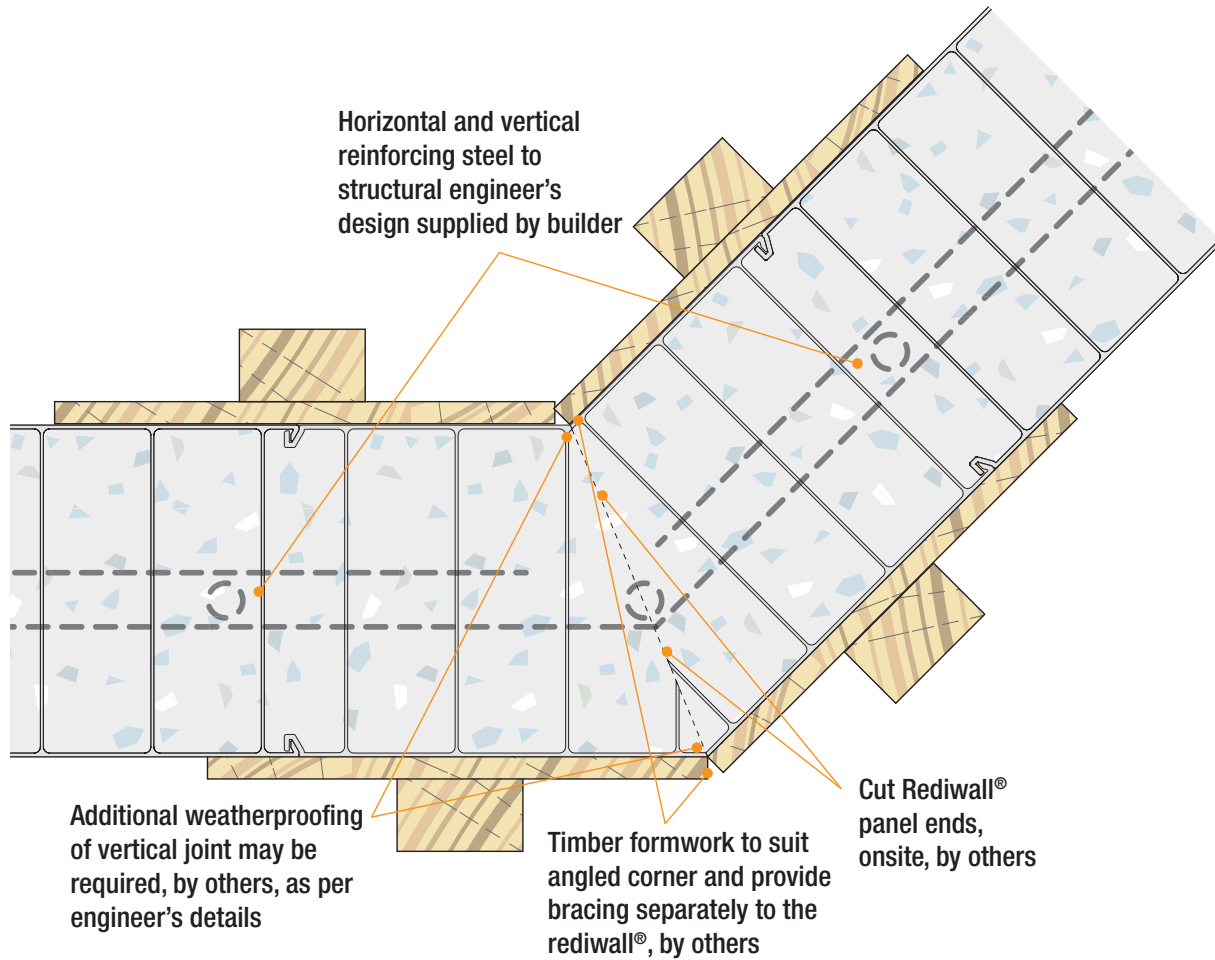

## Notes:

- Refer to Volume 3 – Installation Guide for bracing details.

Fig B15: Movement Joint – Vertical Junction

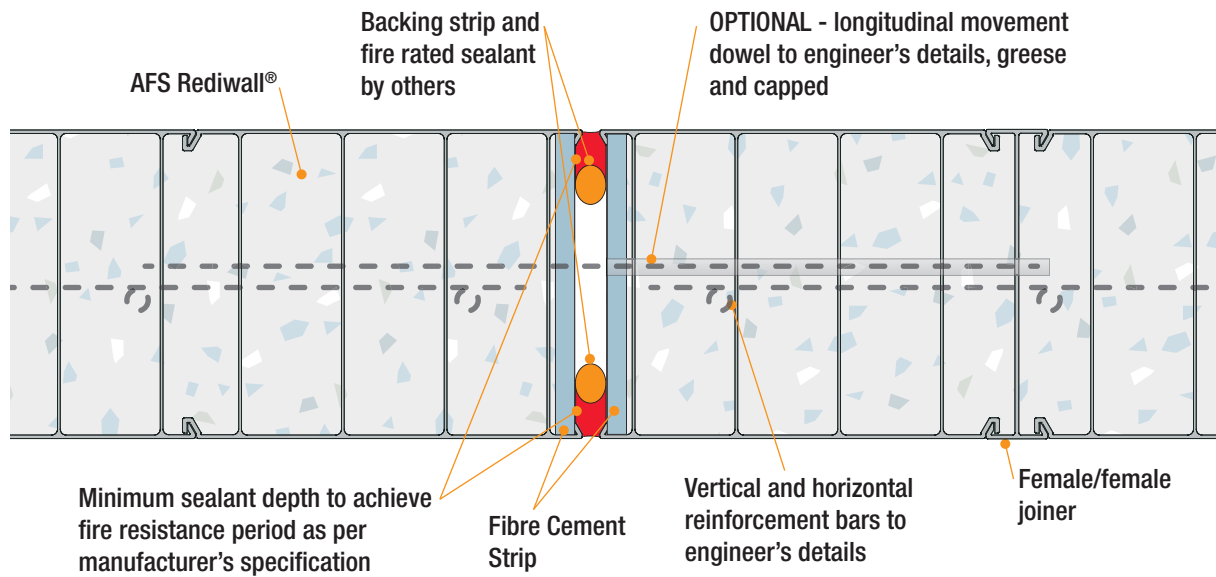

Notes:

- Can be dowel jointed if required structurally.
- Fire rating to be considered in project specifications.
- Refer to Volume 1 – Design, Performance & Compliance Guide, specific wall applications section to determine where this detail can be applied.

Fig B16: Double Height Wall – Horizontal Joint (2 Stage Concrete Fill)

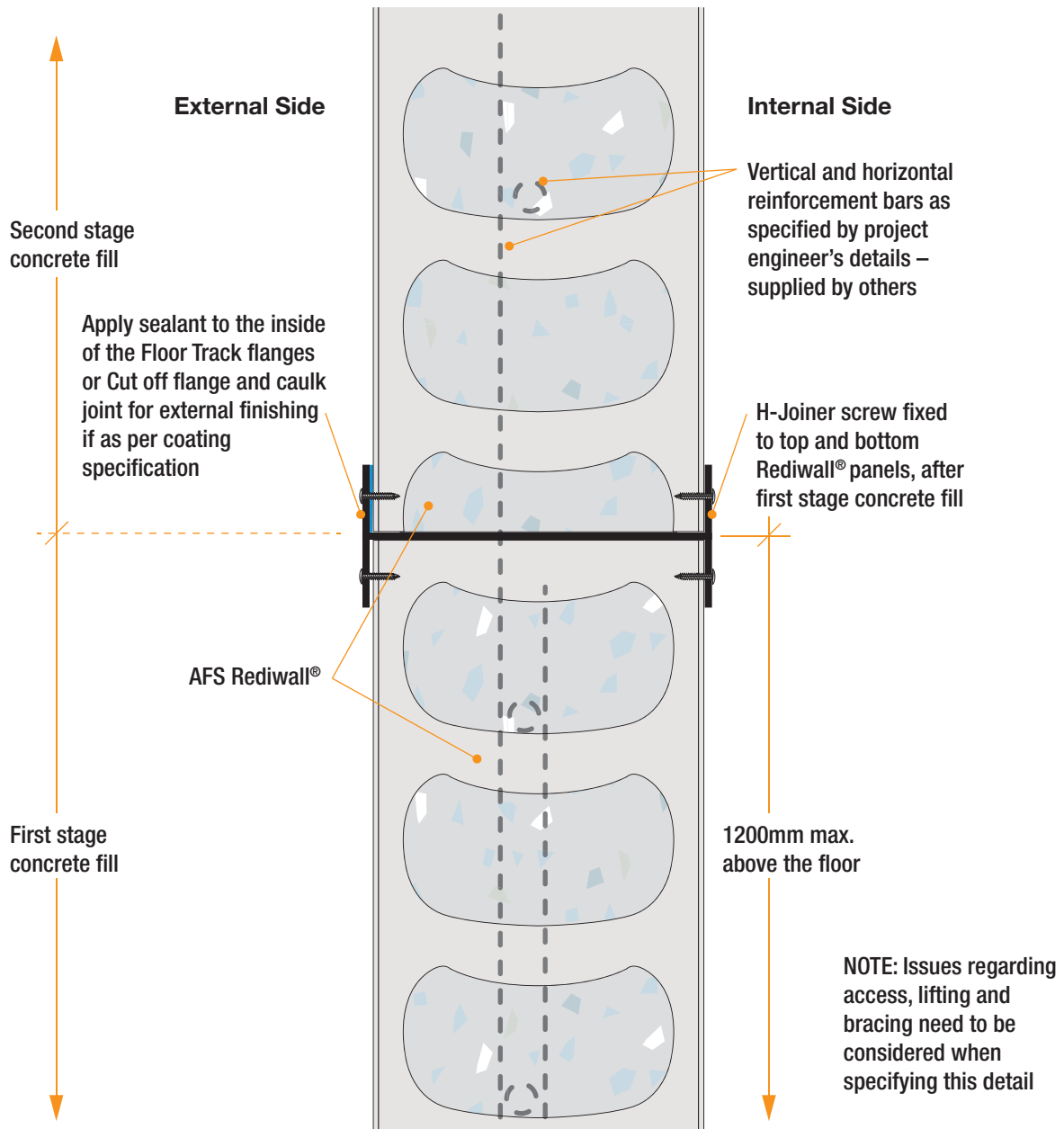

Notes:

- Install second stage upper panels, H-Joiner, reinforcement after first stage concrete fill has occurred.

Fig B17: Junction of Rediwall® Party Wall and External Fire Rated Wall

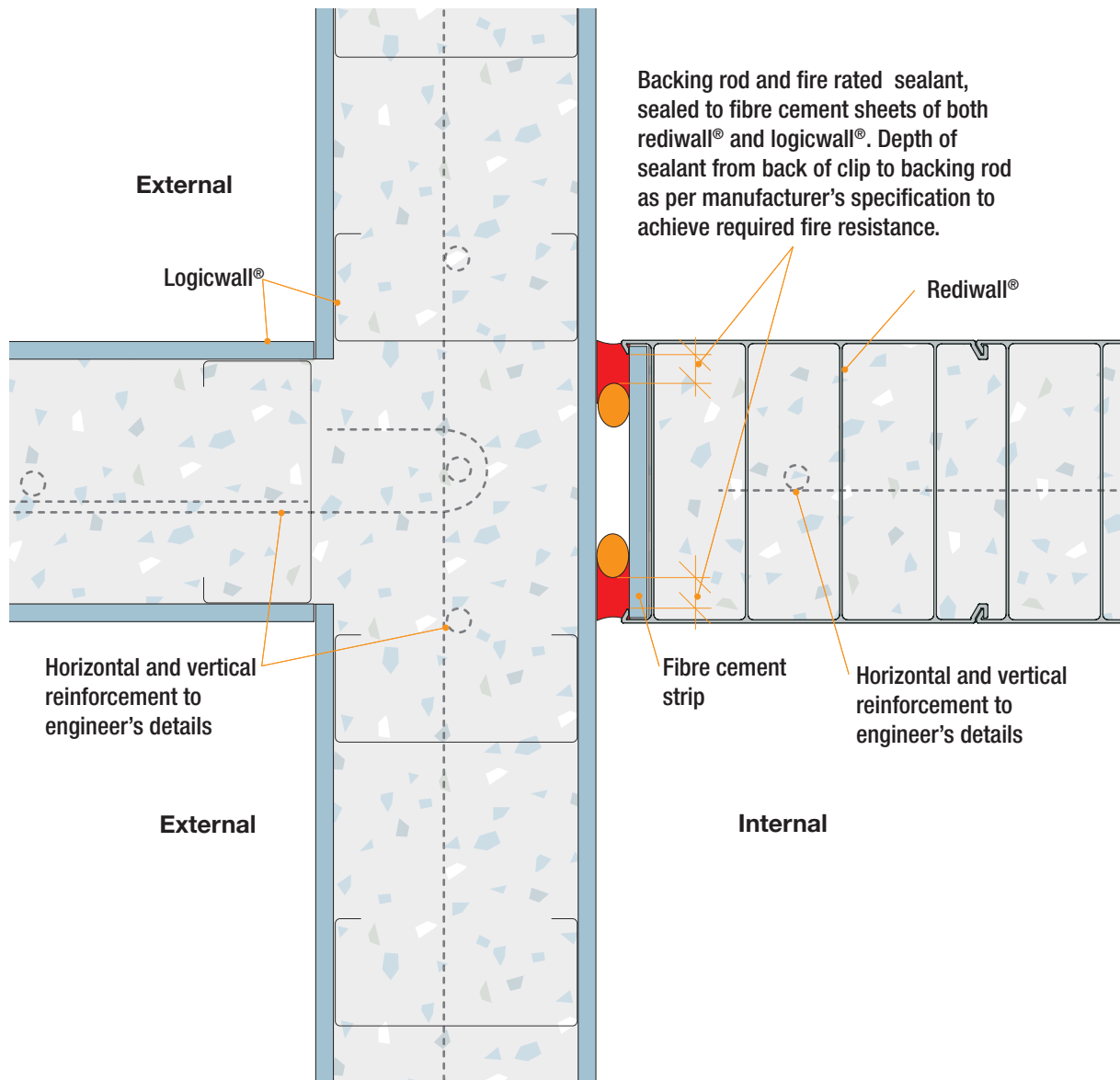

NOTES:

Refer to Volume 1 – Design, Performance & Compliance Guide, specific wall applications section to determine where this detail can be applied.

Fig B18: Rediwall® T-Junction

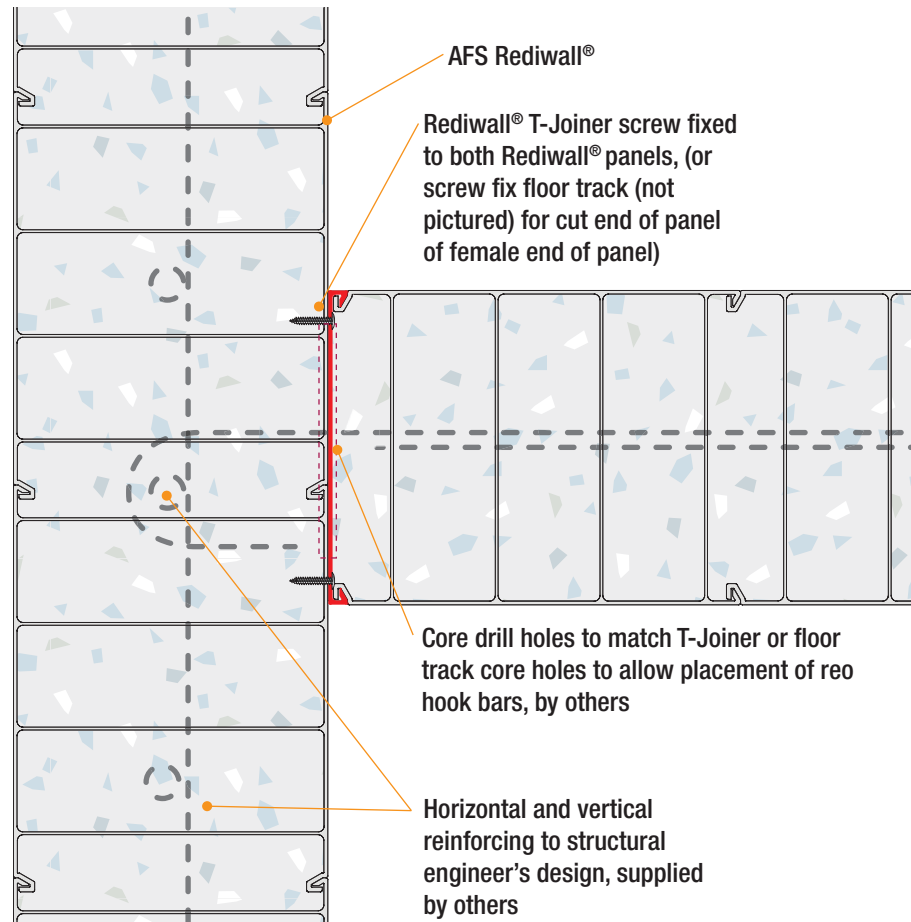

## NOTES:

Refer to Volume 1 – Design, Performance & Compliance Guide, specific wall applications section to determine where this detail can be applied.



Fig B19: Timber Floor Junction

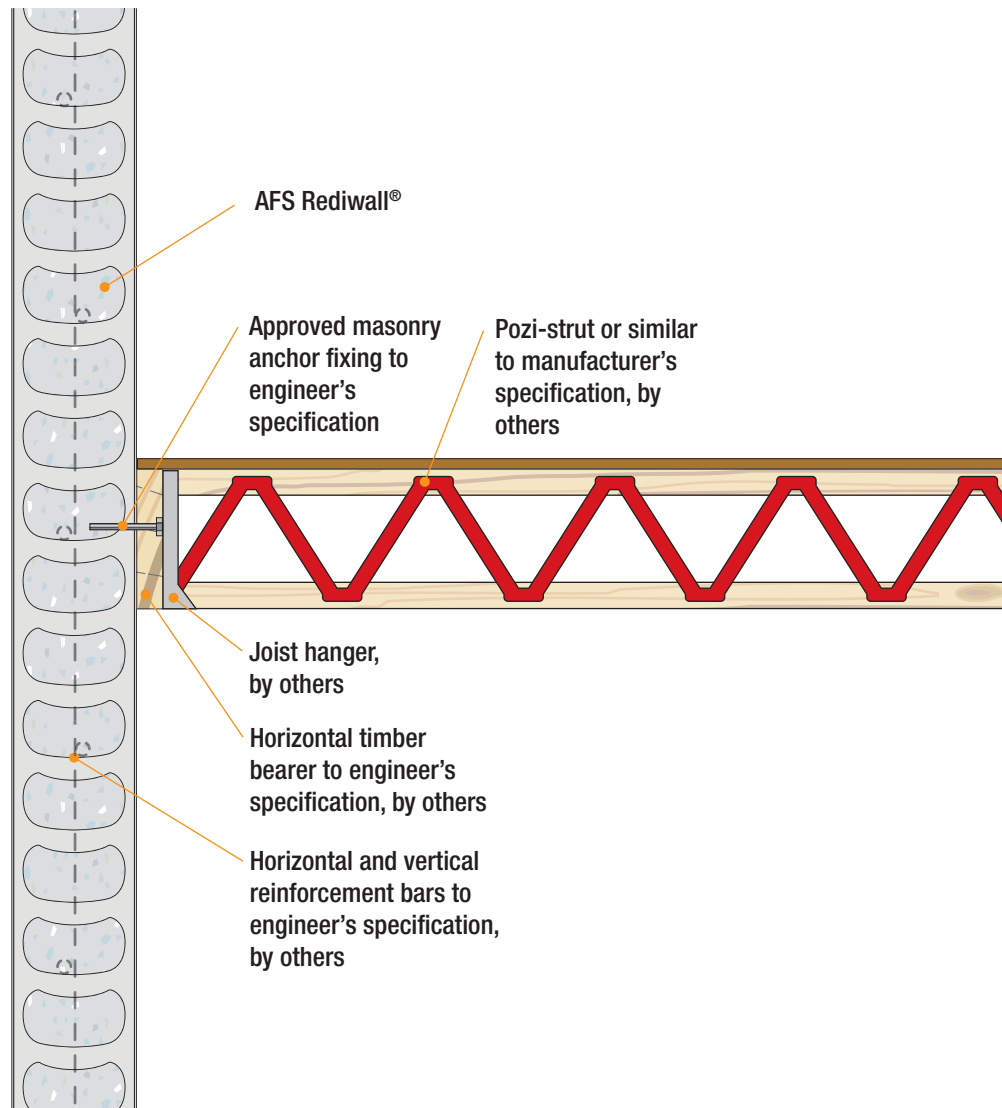
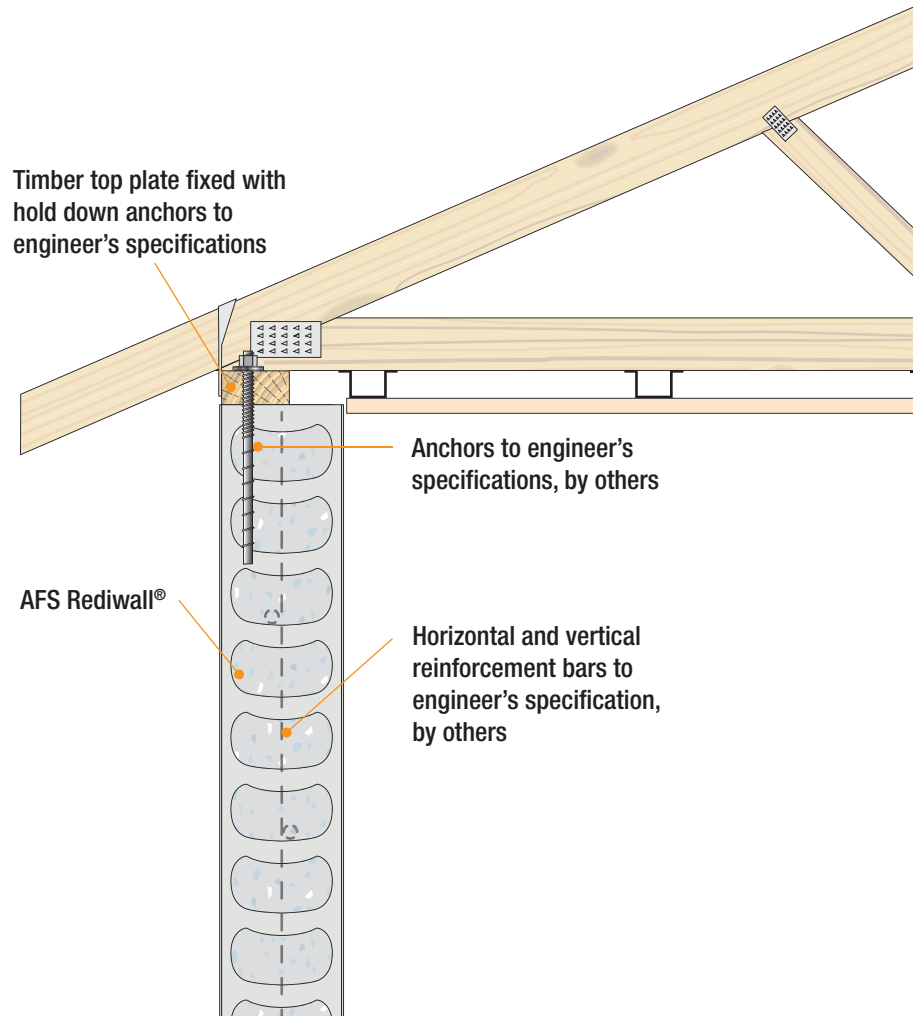

Fig B20: Timber Top Plate Connection



## Openings & Wall Terminations

Fig B21: Door Jamb Options

### Internal Fit – Door Jamb

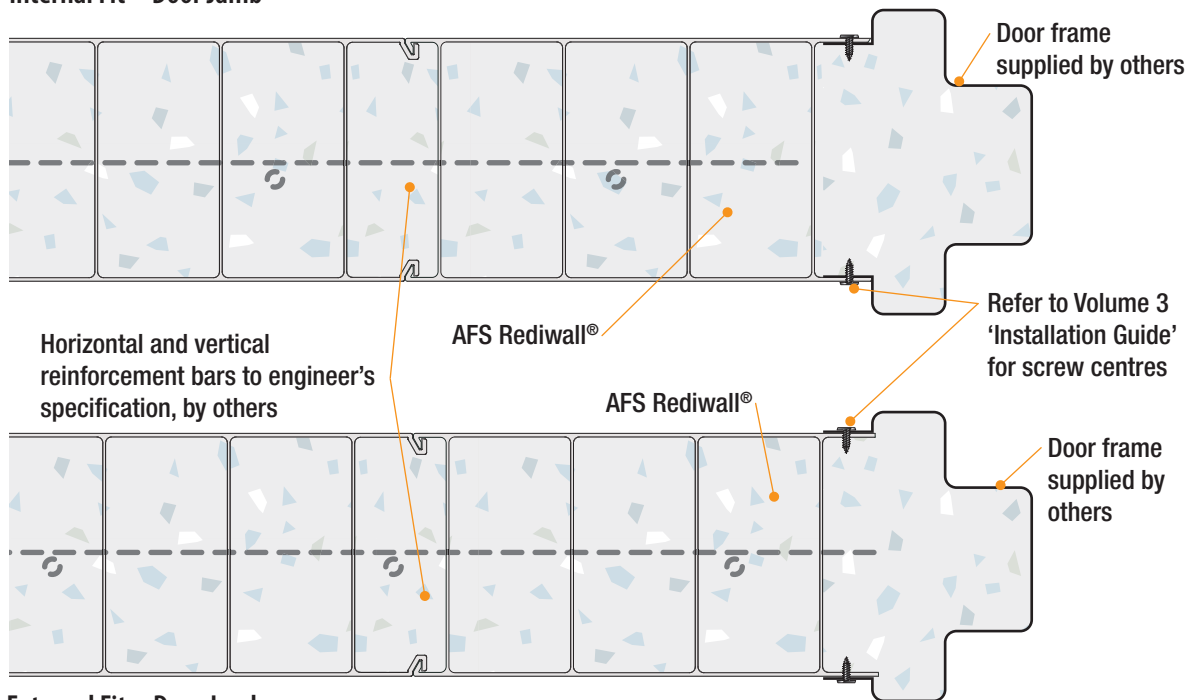

### External Fit – Door Jamb

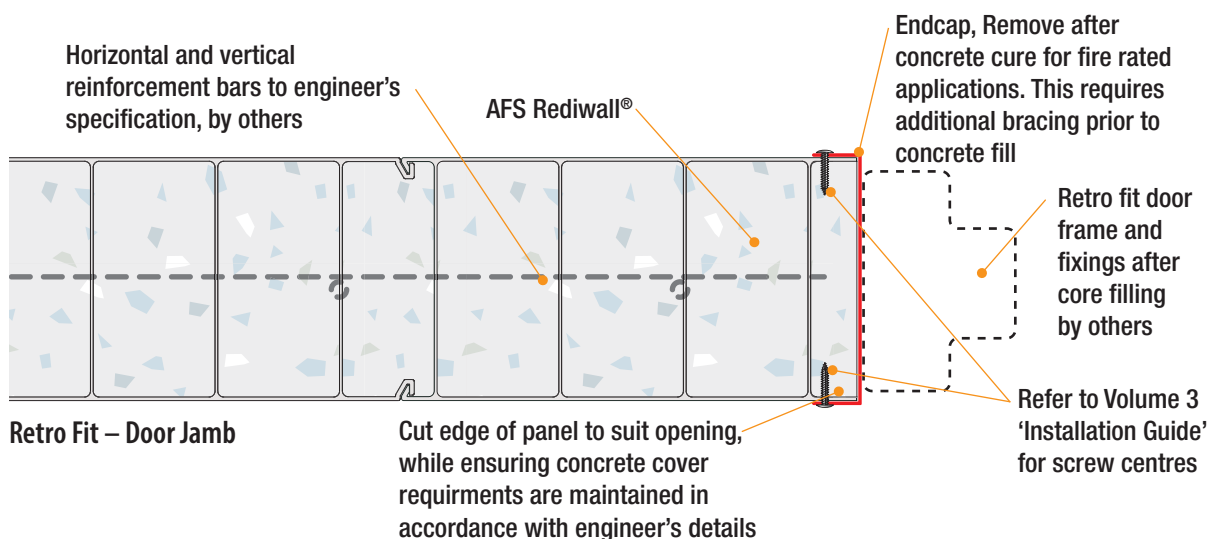

**Notes:**

Always refer to door frame supplier for specific details on installation arrangement of frame to wall to ensure installation complies with door frame supplier's certification.

Fig B22: End Cap Options

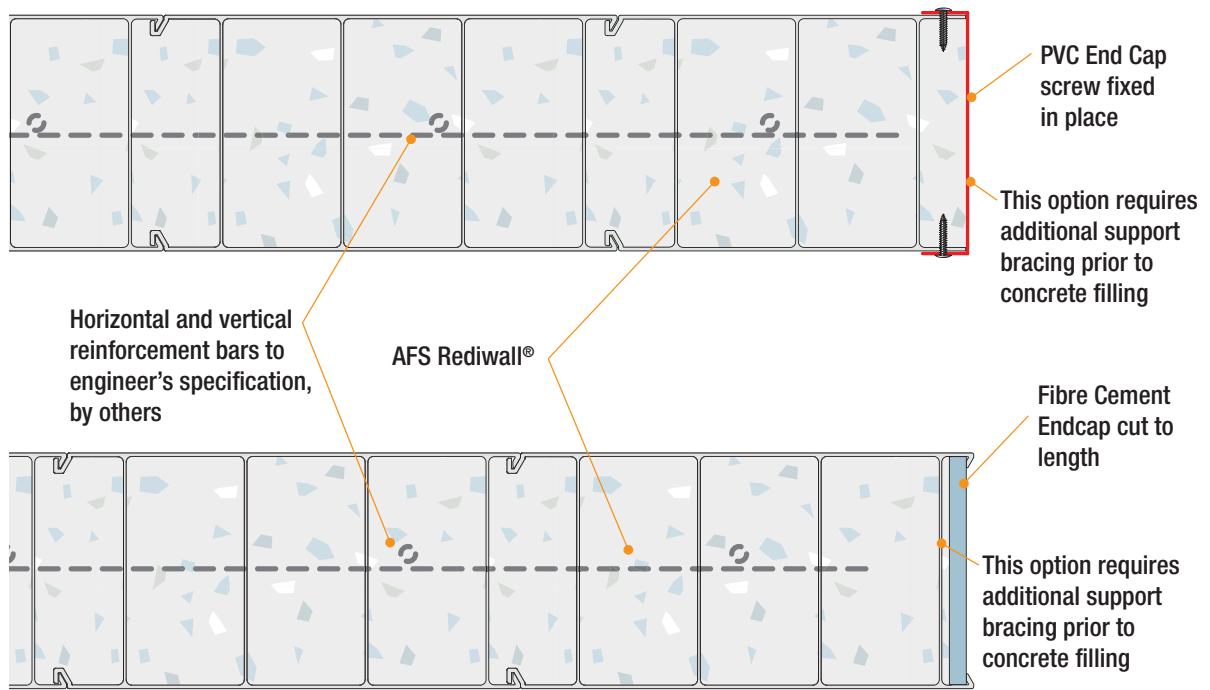
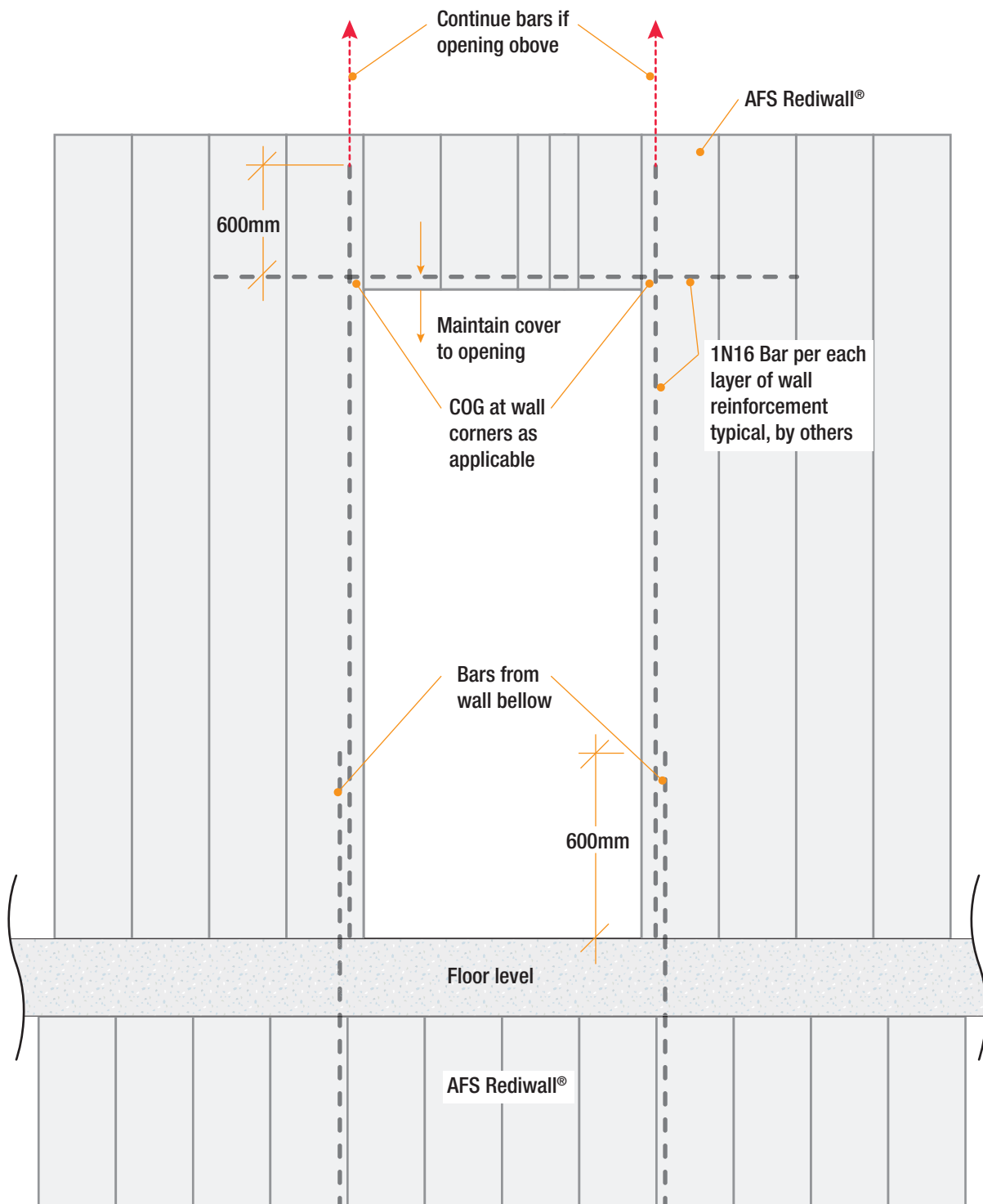

Fig B23: Typical Door Opening



## Notes:

Always refer to engineer's details for specific reinforcement requirements for the door opening

Fig B24: Typical Wall Penetration

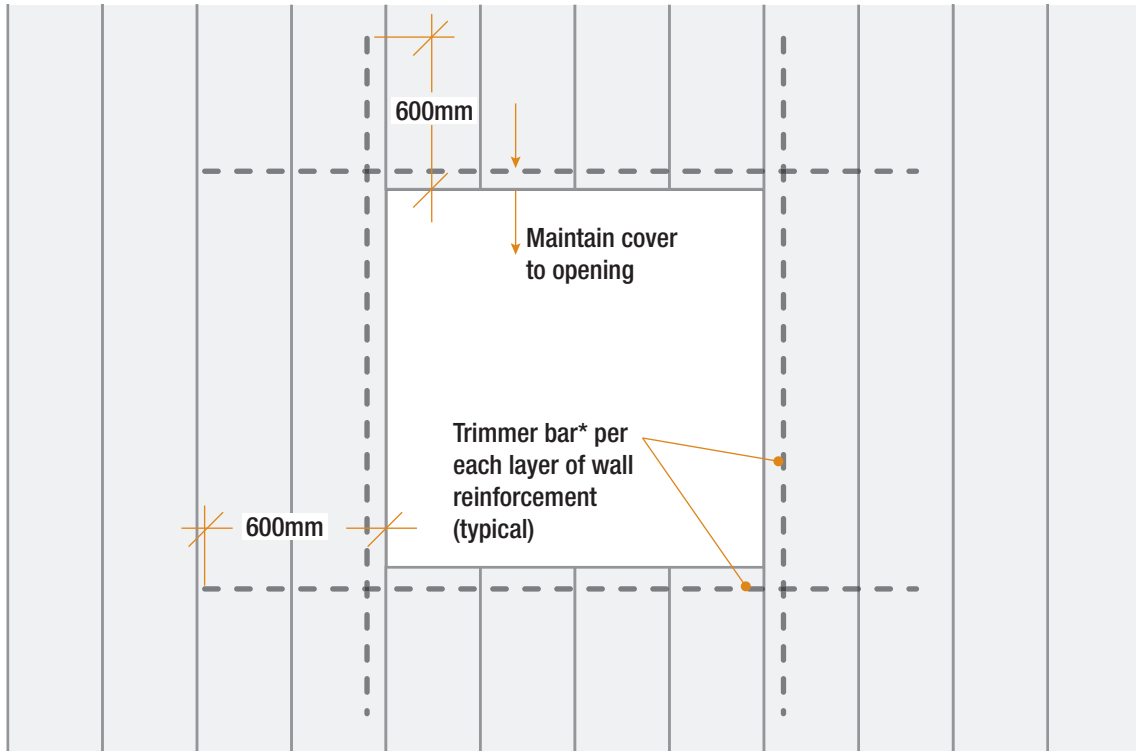

*Trimmer bars recommendations	
Wall penetration size (mm)	Recommended minimum trimmer bar size
250 – 600	1N12
601 – 1200	1N16

Alternatively refer to engineer's details.

Notes:

Always refer to engineer's details for specific reinforcement requirements for opening penetrations.

Fig B25: Typical Opening in Rediwall® - Side Elevation View

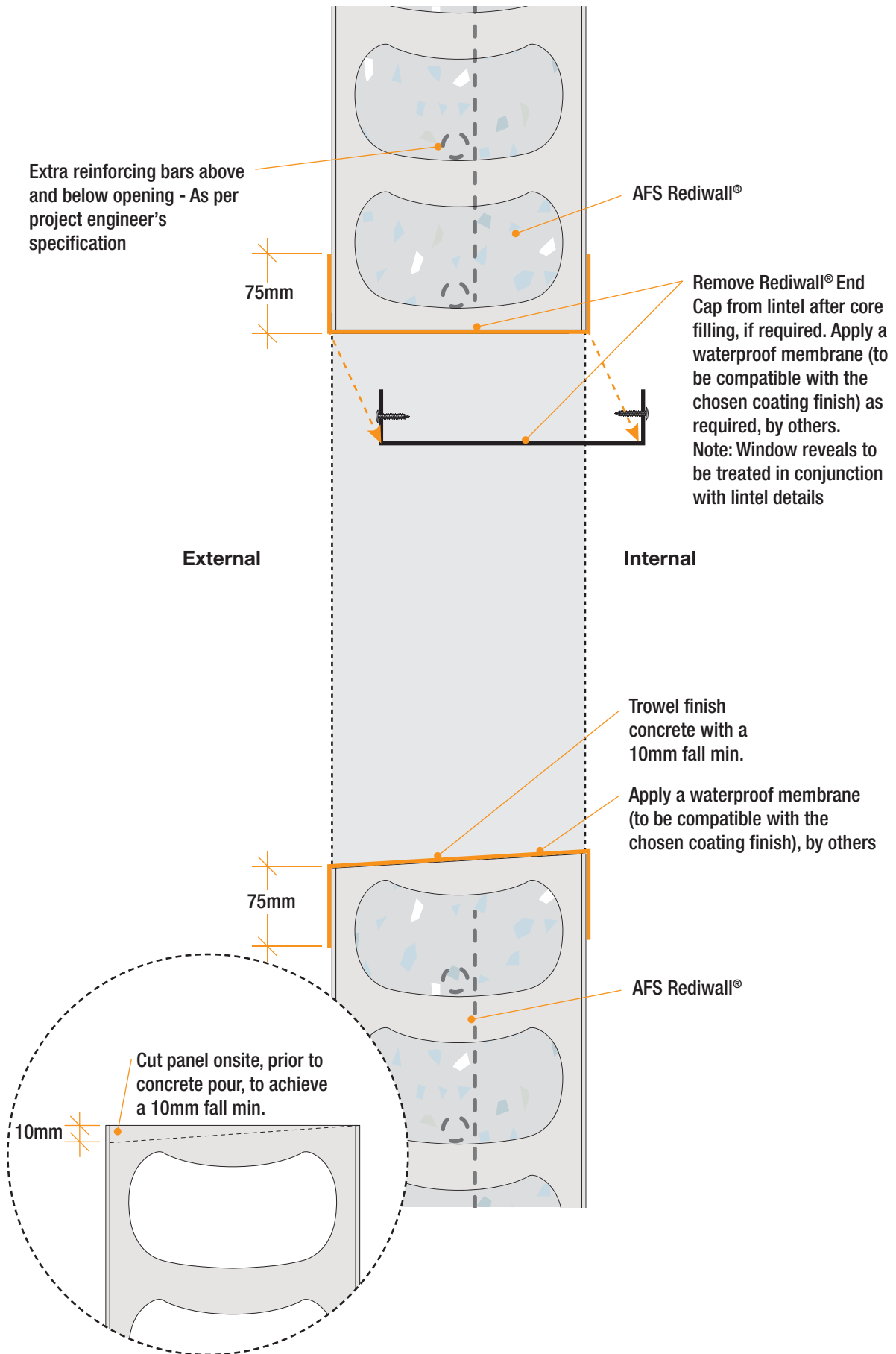
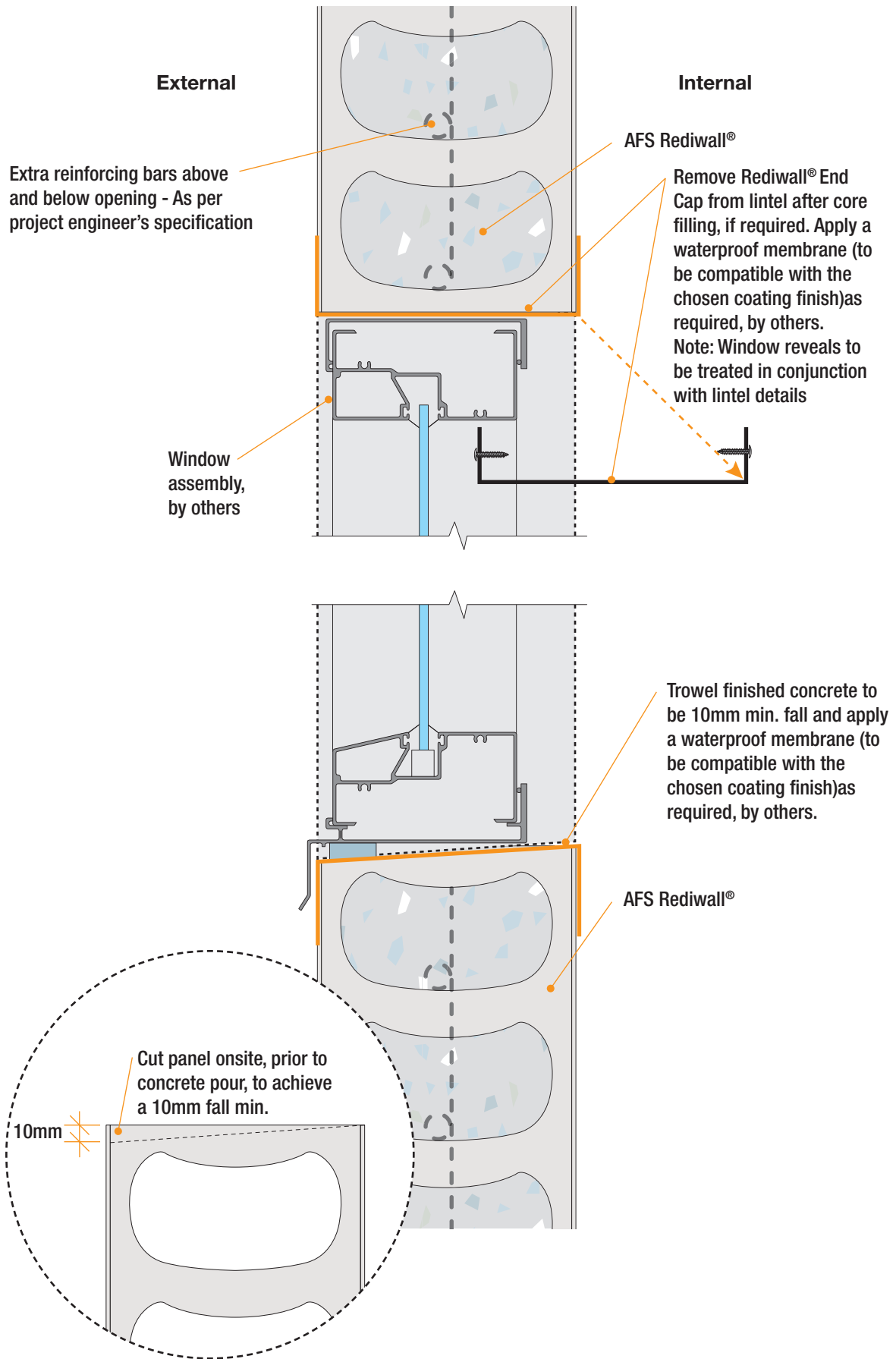

Fig B26: Window Opening - Side Elevation View





## Attachments & Services

Fig B27: Services

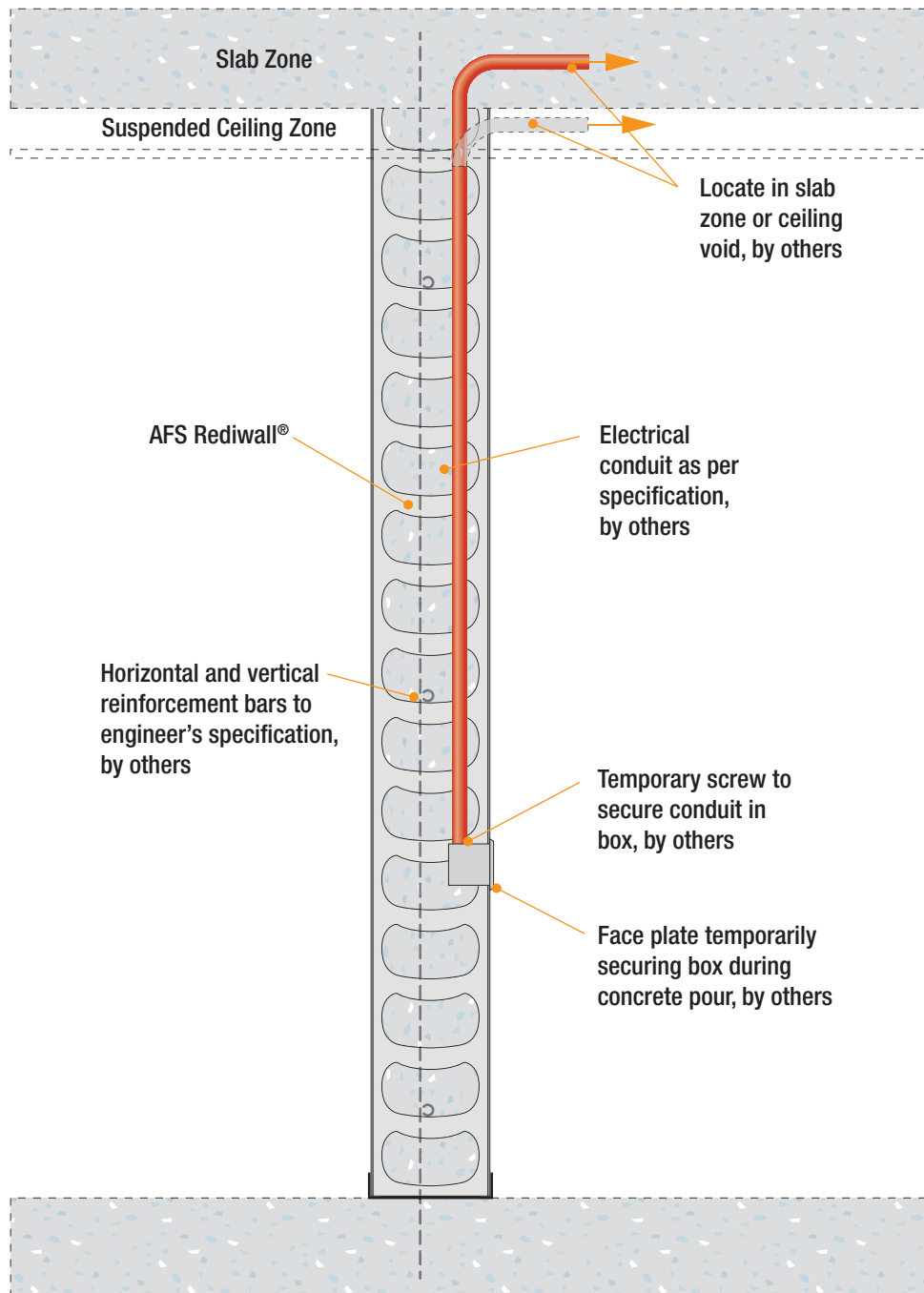

Notes:

- Only non pressure services to be installed inside rediwall®
- Consideration to be given to fire and acoustic design when installing service boxes.
- Refer to Volume 1 Guide for more information in regards to full service penetration details.

## Wall Systems

Fig B28: Typical Party Wall Detail (Continuous Construction)

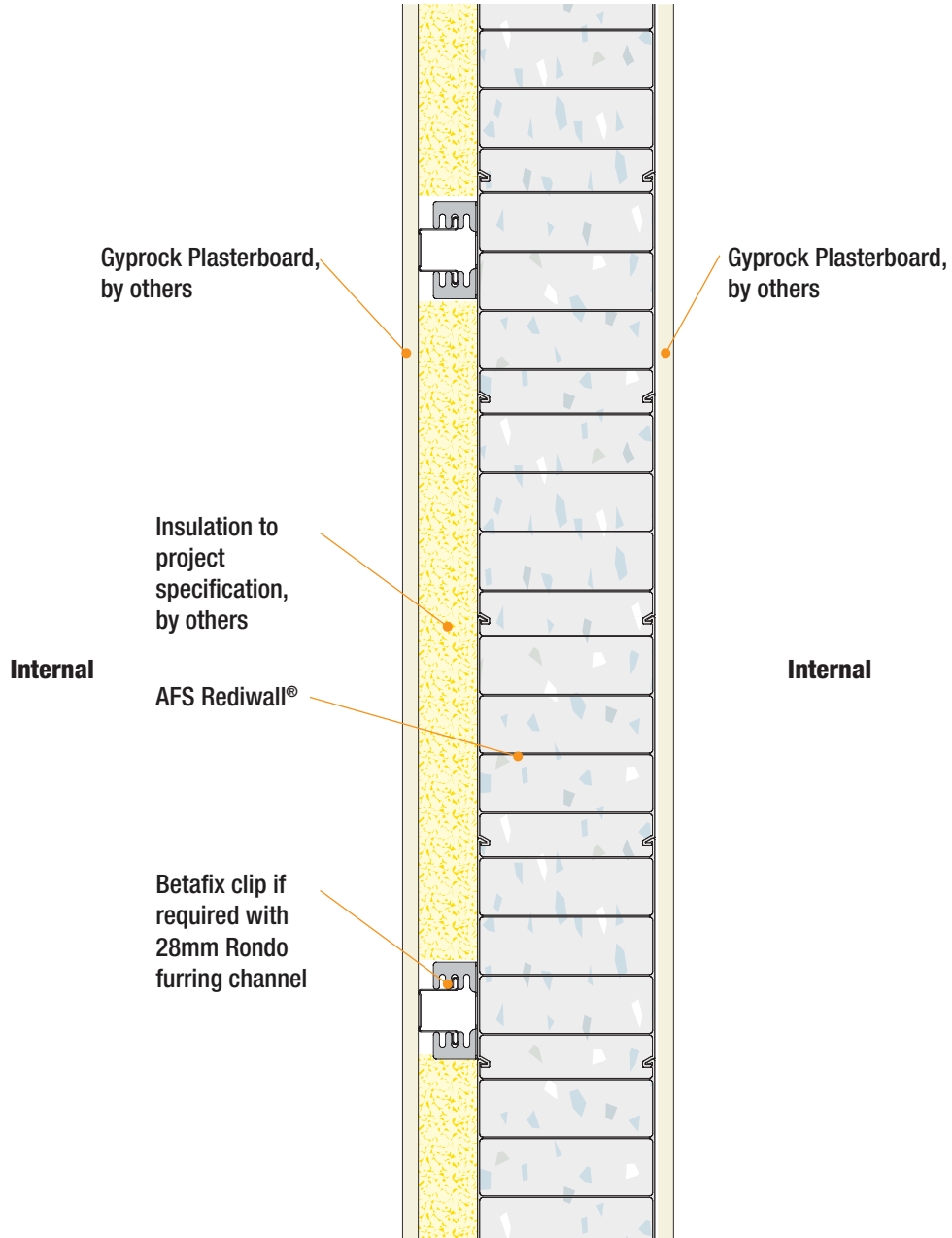
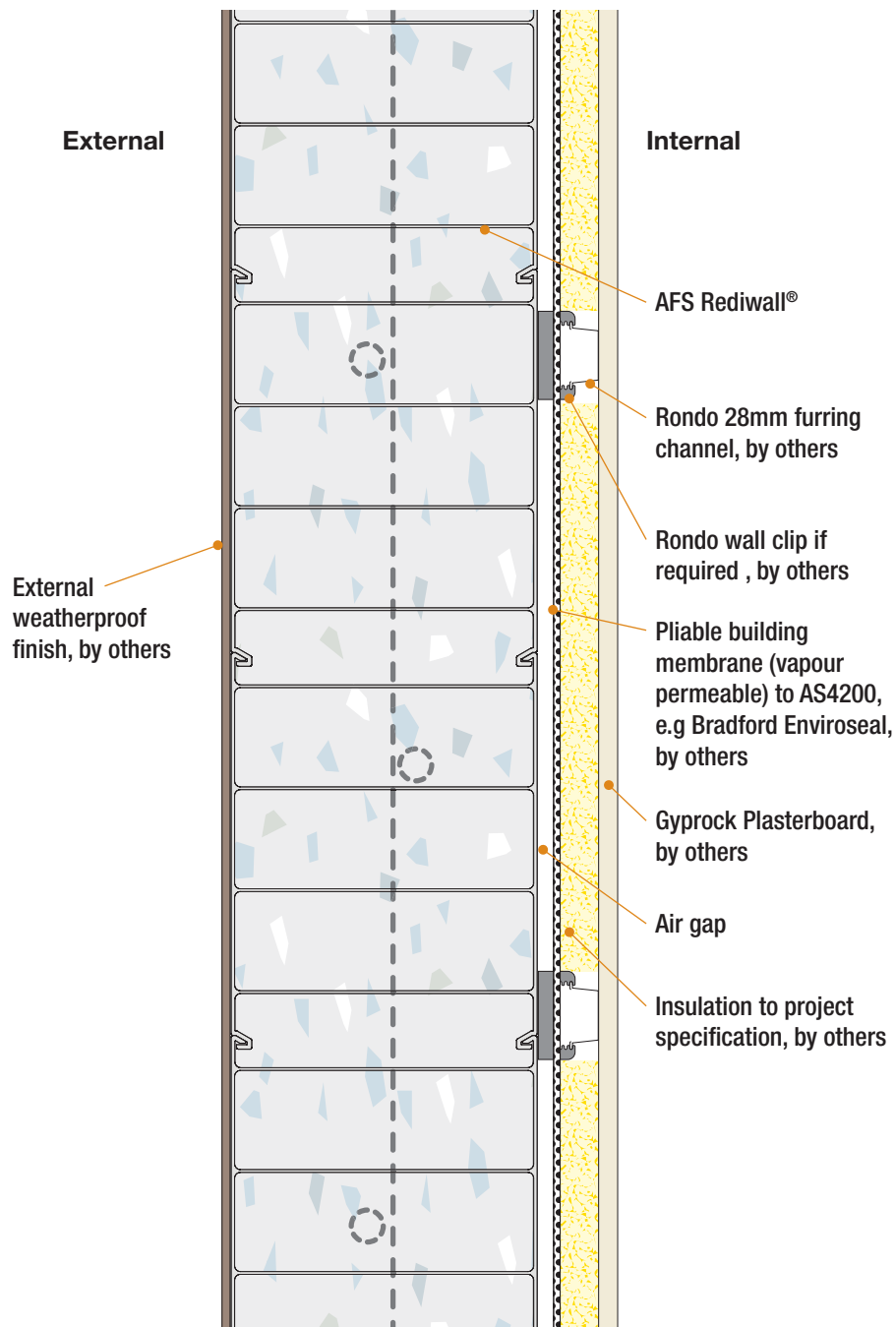

Fig B29: Typical Rediwall® External Wall with Internal Plasterboard Lining on Furring Channel (Continuous Construction)



**Fig B30: Typical Separating Wall (Discontinuous Construction)**

Wet Area/Living Area or Wet to Wet Area (where Plumbing Services are to be installed to one side only)

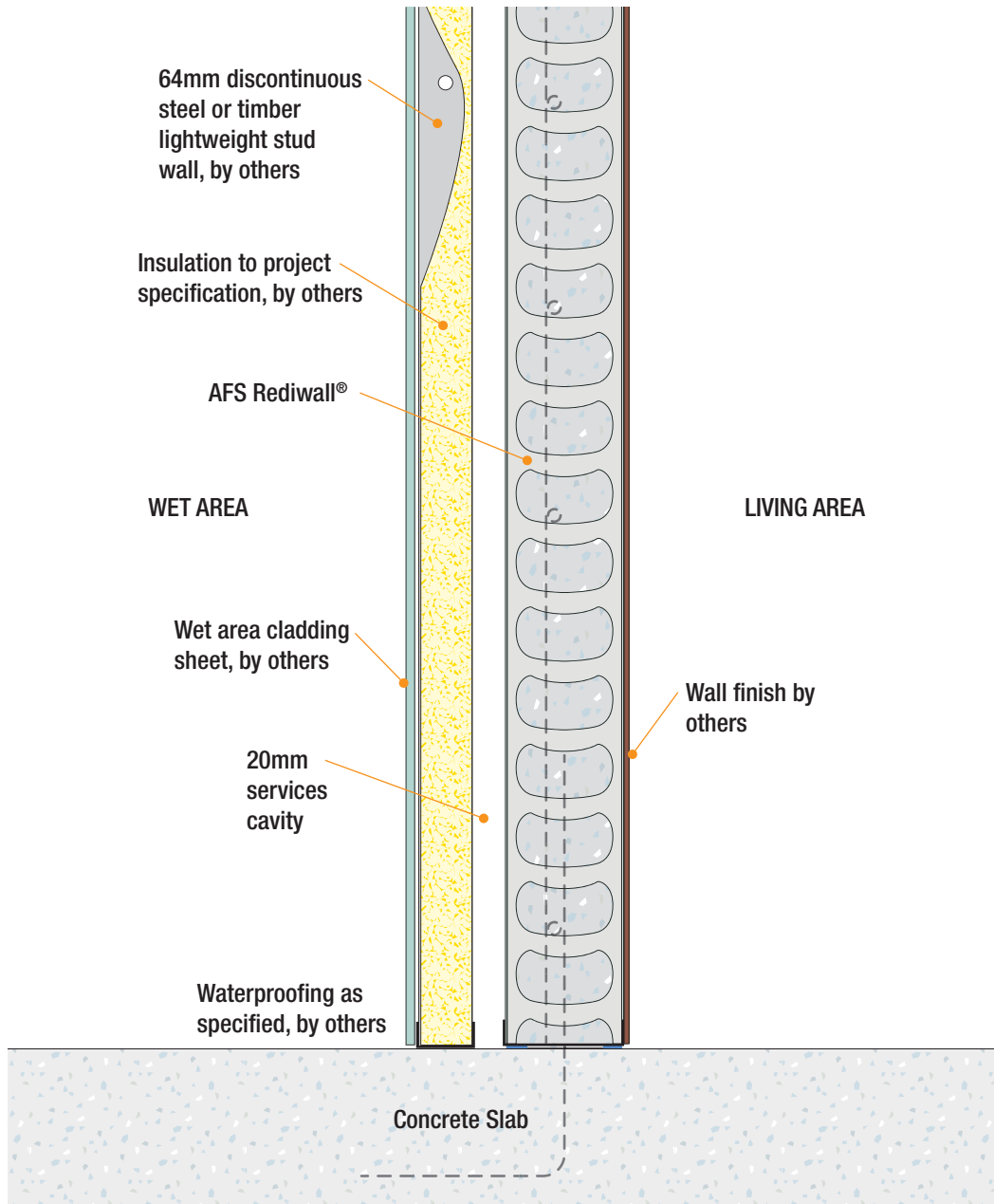

Fig B31: Rediwall® Boundary Wall Capping (Elevation View)

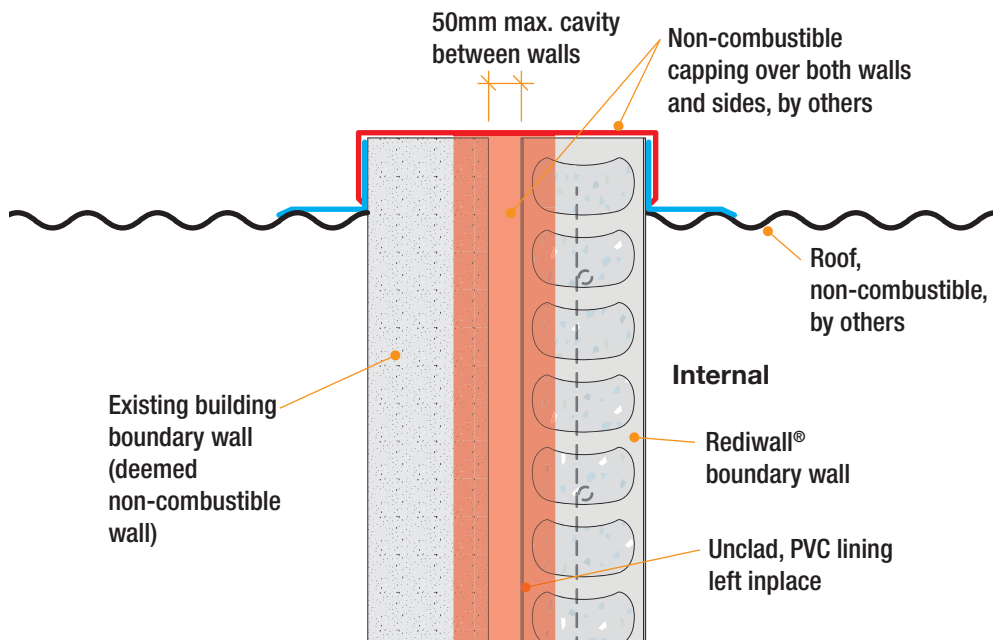
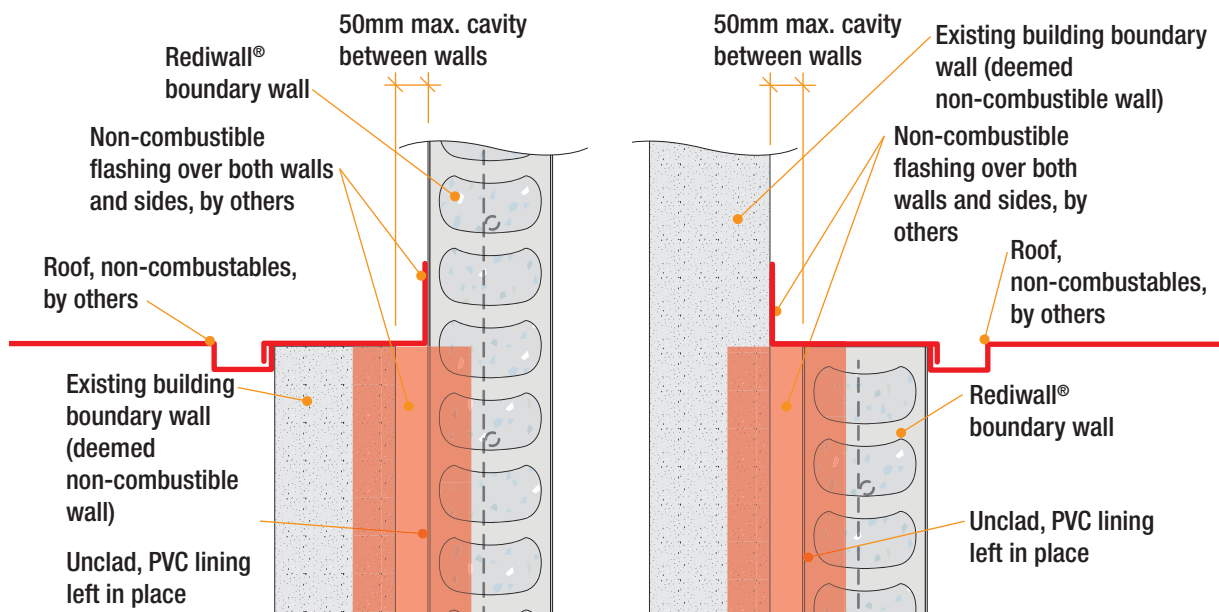

Fig B32: Rediwall® Boundary with Different Wall Heights



## NOTES:

Refer to Volume 1 – Design, Performance & Compliance Guide, specific wall applications section to determine where this detail can be applied.

# Rediwall® Finishing Treatments

---

## Introduction

The use of PVC in rediwall® permanent formwork provides a durable, attractive and water resistant surface for concrete walls. AFS rediwall® can be finished in a number of treatments for internal and external wall applications that enhance the overall wall system's:

- Acoustic, fire and non-combustibility performance,
- Architectural surface, and
- Weather resistance with external walls.

For best results these should be considered in the planning stages of the project and be clearly set out in the specifications.

## Rediwall® Non-Combustible Compliant Finishing Treatments

Rediwall® can use a variety of finishing treatments, these have been assessed by Stephen Grubits and Associates, Fire Safety Engineers for their suitability to meet non-combustibility requirements of the NCC. The various finishing treatments are shown in the following diagrams.

Reference should be made to TABLE A10 & TABLE A11 – Volume 1, to determine where the finishing treatments can be used, and any particular requirements that have been identified for each finish and application.

Fig B33: Unclad Rediwall® With PVC Lining Left In Place – Finish Type (a)

Finish Type (a)

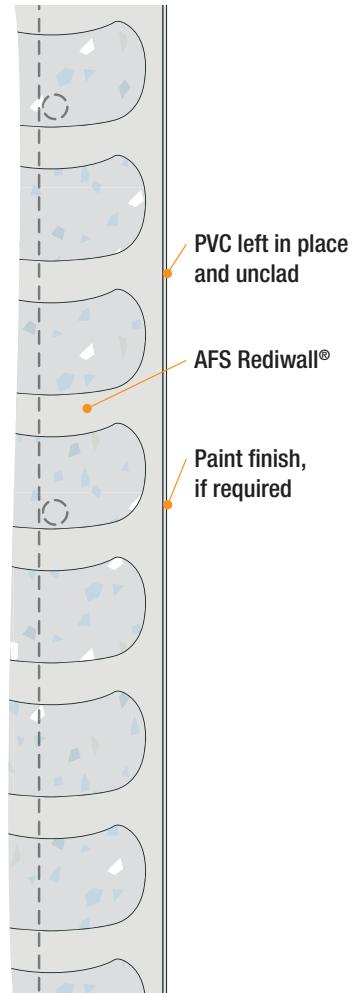

NOTES:

Refer to Volume 1 – "TABLE A10: Summary of compliance with Performance Requirements & Essential Safety Precautions" to determine where this finish can be used.

– Ensure paint coating complies to requirements of the NCC.

Fig B34: Non-Combustible Cement Render (or Similar Finish) Over Rediwall® PVC Lining – Finish Type (b)

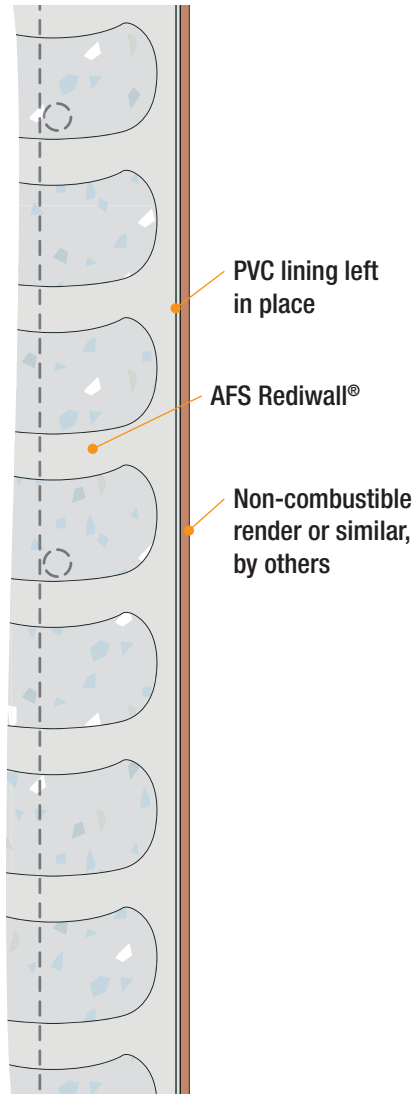

NOTES:

Refer to Volume 1 – "TABLE A10: Summary of compliance with Performance Requirements & Essential Safety Precautions" to determine where this finish can be used.



Fig B35: Plasterboard Direct Fixed To Rediwall® – Finish Type (c)

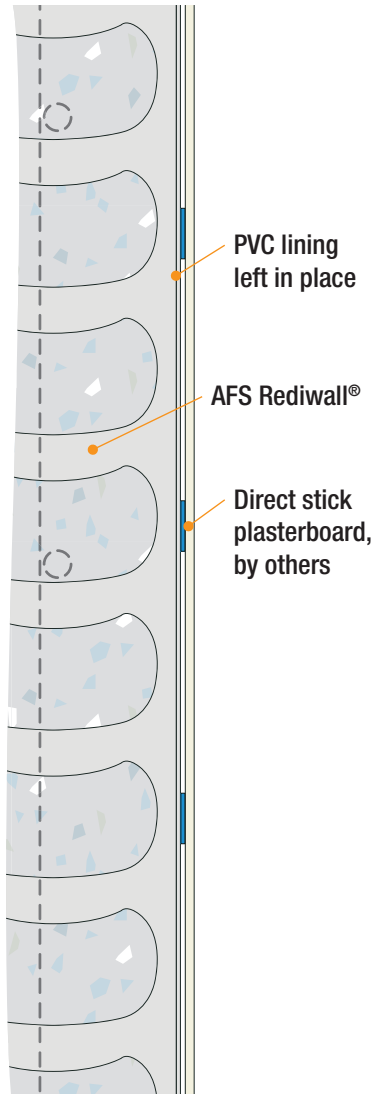

NOTES:

Refer to Volume 1 – "TABLE A10: Summary of compliance with Performance Requirements & Essential Safety Precautions" to determine where this finish can be used.

Fig B36: Plasterboard Lining and Horizontal Steel Furring Channels Fixed To Rediwall® – Finish Type (d)

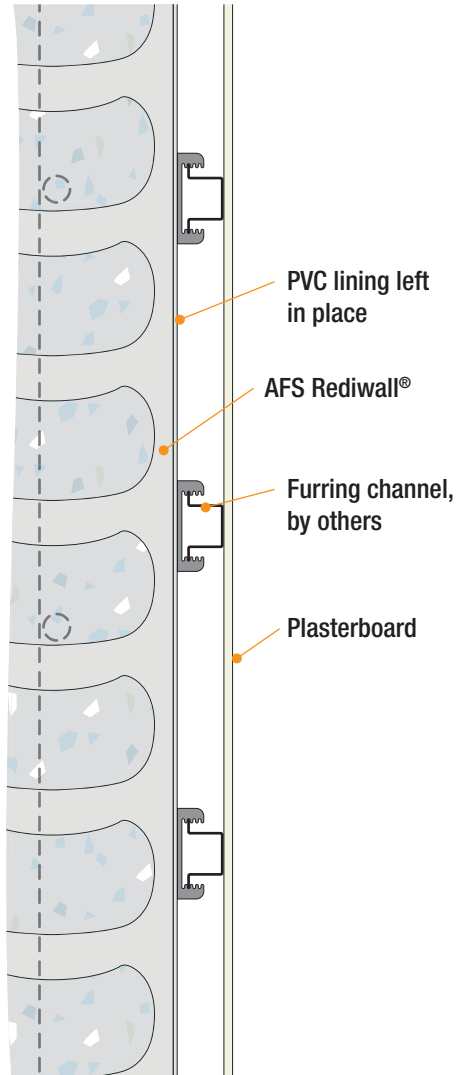

NOTES:

Refer to Volume 1 – "TABLE A10: Summary of compliance with Performance Requirements & Essential Safety Precautions" to determine where this finish can be used.

Fig B37: Rediwall® With Face Brick Exterior Skin – Finish Type (e)

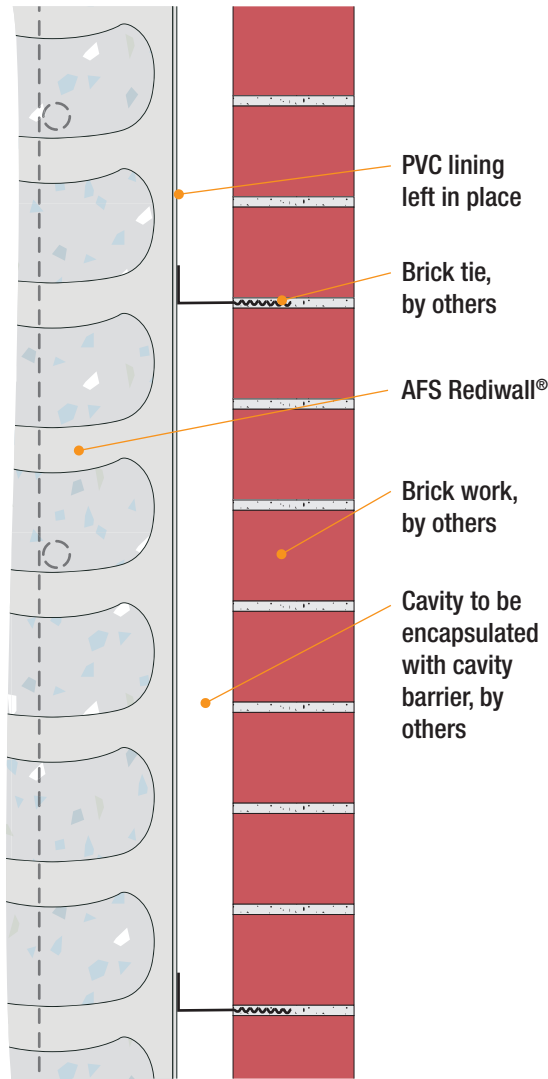

NOTES:

Refer to Volume 1 – "TABLE A10: Summary of compliance with Performance Requirements & Essential Safety Precautions" to determine where this finish can be used.

Fig B38: Tile System (<math><32\text{kg/m}^2</math>) Mechanically Fixed To Rediwall® – Finish Type (f)

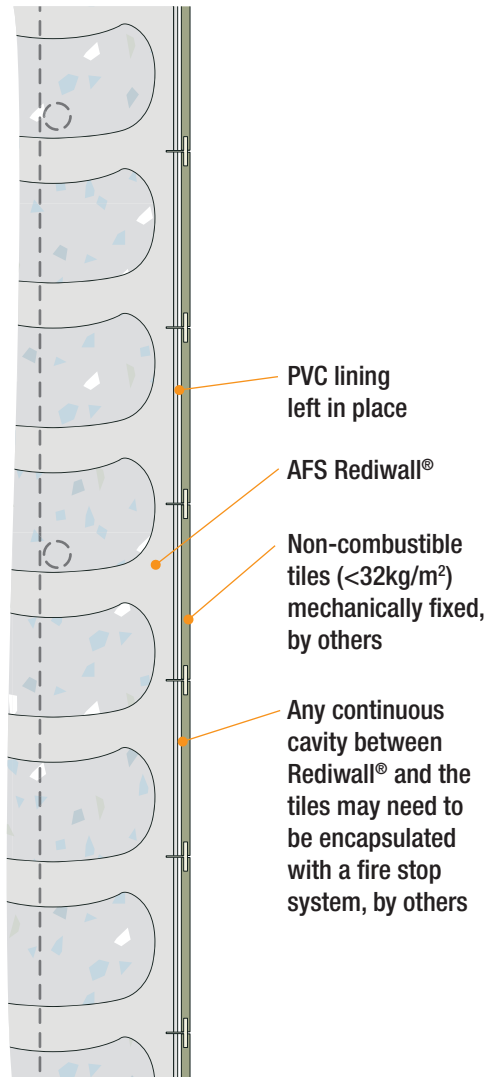

NOTES:

Refer to Volume 1 – "TABLE A10: Summary of compliance with Performance Requirements & Essential Safety Precautions" to determine where this finish can be used.

Fig B39: Mechanically Fixed Non-Combustible Cladding To Rediwall® – Finish Type (g)

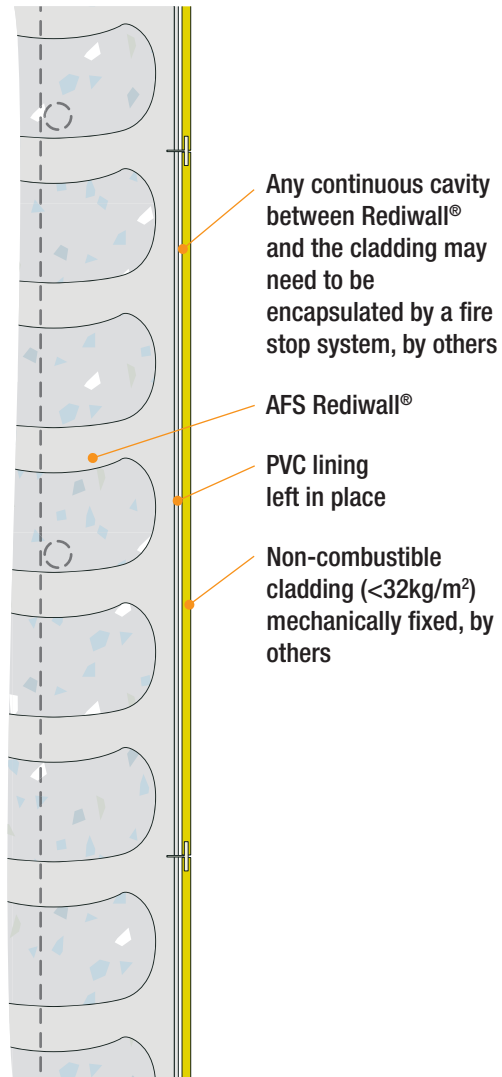

NOTES:

Refer to Volume 1 – "TABLE A10: Summary of compliance with Performance Requirements & Essential Safety Precautions" to determine where this finish can be used.

Fig B40: Tile System (<math><32\text{kg/m}^2</math>) Adhesive Fixed To Rediwall® – Finish Type (i)

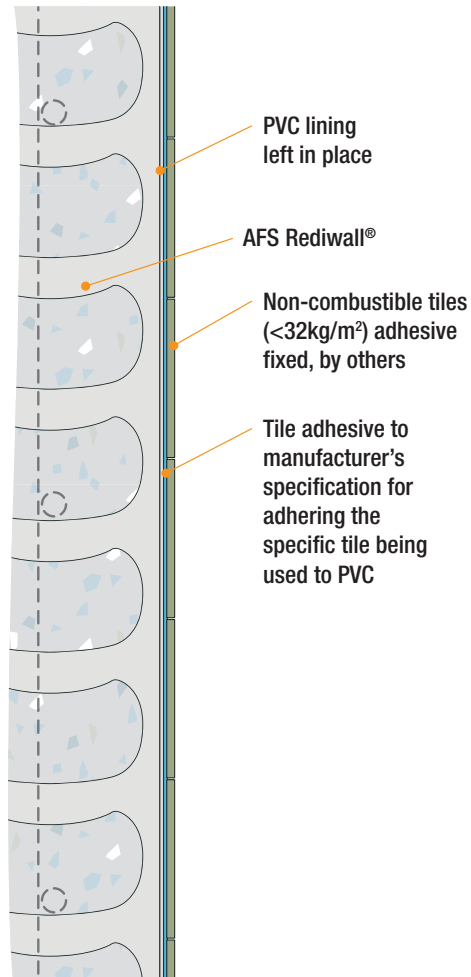

NOTES:

Refer to Volume 1 – "TABLE A10: Summary of compliance with Performance Requirements & Essential Safety Precautions" to determine where this finish can be used.

Fig B41: Adhesive Fixed Non-Combustible Cladding To Unclad Rediwall® – Finish Type (h)

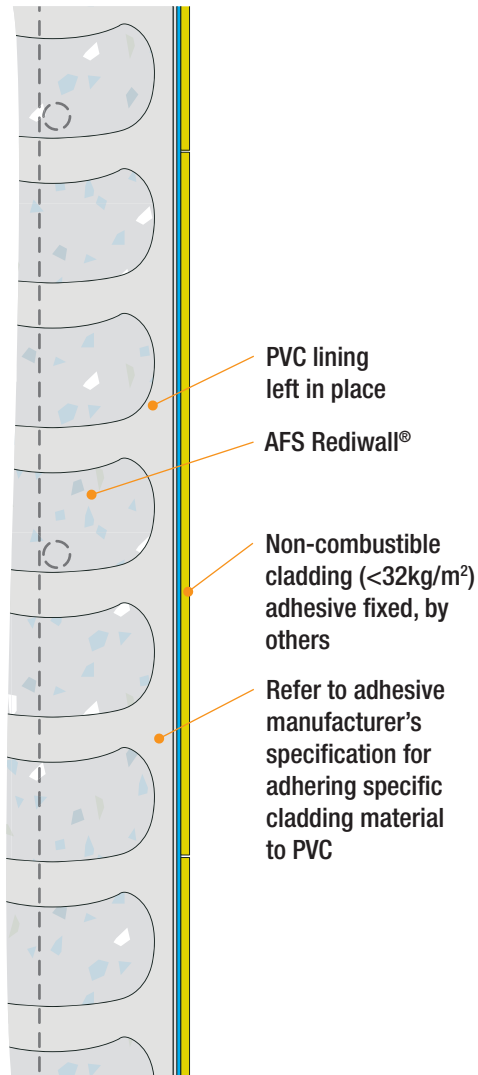

NOTES:

Refer to Volume 1 – "TABLE A10: Summary of compliance with Performance Requirements & Essential Safety Precautions" to determine where this finish can be used.

NOTES:

A large rectangular area filled with a grid of small, evenly spaced dotted lines, intended for writing notes.



NOTES:

A large rectangular area filled with a grid of small, evenly spaced dotted lines, intended for writing notes.

PVC-based permanent formwork for basements, columns, blade & party walls, lift & stair cores, retaining walls and retention tanks



**Disclaimer:** The products referred to in this document have been manufactured by or on behalf of CSR Building Products Limited ("CSR") to comply with the Building Code of Australia and any relevant Australian Standards. While any design or usage guidelines set out in this document have been prepared in good faith by CSR, they are of a general nature only and are intended to be used in conjunction with project specific design and engineering advice. It is the responsibility of the customer to ensure that CSR's products are suitable for their chosen application, including in respect of project-specific matters such as, but not limited

structural adequacy, acoustic, fire resistance/combustibility, thermal, and weatherproofing requirements. All information relating to design/installation/application of these products is offered without warranty and no responsibility can be accepted by CSR for errors and omissions, or for any use of the relevant products not in accordance with CSR's technical literature or any other relevant industry standards. For current technical and warranty documentation relating to CSR's products, visit the AFS website at [www.afsformwork.com.au](http://www.afsformwork.com.au)

(C) 2023 AFS Systems Pty Ltd ABN 455 760 727 88  
BMS1929 1023 – October 23

**afs**

[afsformwork.com.au](http://afsformwork.com.au) • 1300 727 237

AFS Systems Pty Ltd • 110 Airds Road, Minto NSW 2566

**CSR**



# Installation Guide

System Overview, Components, Tools, Accessories,  
Construction Process, Installation Procedures,  
Bracing & Core Filling

# Table Of Contents

<b>Table Of Contents</b>	<b>2</b>		
Legal Statements.....	3		
<b>Introduction</b>	<b>4</b>		
<b>System Overview</b>	<b>5</b>		
Rediwall® Product Description .....	8		
Rediwall® System Benefits.....	8		
<b>Components, Tools &amp; Accessories</b>	<b>9</b>		
Components for RW110C System.....	9		
Components for RW156C System.....	11		
Components for RW200C System.....	14		
Components for RW256S System .....	17		
Components for RW275S System .....	19		
Components for RW300S System .....	21		
Tools & Accessories .....	23		
Workplace Health Safety and the Environment.....	24		
<b>The Construction Process</b>	<b>27</b>		
Construction Process Overview .....	27		
Ordering .....	30		
How to order .....	30		
<b>Construction and Installation Procedures</b>	<b>31</b>		
Introduction .....	31		
Component Delivery & Worksite Layout .....	32		
Floor/Wall Junction – Floor Track Installation .....	33		
Control Joints .....	35		
Starting Location.....	35		
Corner Construction .....	36		
Wall Construction.....	37		
Wall Reinforcement .....	38		
Steel Reinforcement Installation – Single layer .....	38		
Corner Reinforcement Installation With Ezy-fit™			
Corner Cap.....	39		
Corner Reinforcement Installation With Ezy-fit™			
Corner Cap.....	40		
Steel Reinforcement Installation – Double layer .....	41		
Steel Reinforcement Installation – Double layer .....	42		
Steel Reinforcement Installation – Double layer .....	43		
Steel Reinforcement Installation – Double layer .....	44		
Steel Reinforcement Installation – Double Layer .....	45		
Base Track installation.....	46		
Steel Reinforcement Installation – Lowest Ligature			
Steel Reinforcement Installation – Subsequent			
Ligatures.....	48		
Steel Reinforcement Installation – Subsequent			
Ligatures (continued).....	49		
Steel Reinforcement Installation – Ligatures Above			
Starter Bars .....	50		
Steel Reinforcement Installation – Hook Bars .....	51		
Corner Installation – RW200C, Hooked U-Bars or			
Closed Ligatures.....	52		
		Corner Installation –RW200C, Hooked U-Bars or	
		Closed Ligatures.....	53
		Corner Installation –RW200C, Hooked U-Bars or	
		Closed Ligatures.....	54
		Corner Installation – RW256S, RW275S, RW300S –	
		Open Corner.....	55
		Corner Installation – RW256S, RW275S, RW300S –	
		Open Corner.....	56
		Wall Construction.....	57
		Safety Rail/Balustrade Wall Installation .....	58
		T-Junction Construction .....	59
		Obtuse Corner Construction .....	60
		H-Joiner Installation .....	62
		H-Joiner Installation (Limited Site Access) .....	63
		Accessory Extensions .....	64
		End Cap Installation .....	65
		RW256S, RW275S and RW300S Blade Walls .....	66
		Column Construction .....	67
		U-bar Installation.....	68
		Rediwall® Edge Form.....	69
		Rediwall® J-Track Installation .....	70
		Window Openings .....	71
		Doorway & Lintel Installation .....	73
		RW200C 15° Panel – Curved Wall Installation .....	76
		Wide Radius Curved Wall Installation .....	77
		Curved Wall Reinforcement Bar Installation .....	78
		Stairway Landing Construction .....	79
		Retention Tank Construction & Tanking .....	80
		Lift Pit .....	81
		Installation of Services.....	82
		Penetrations .....	83
		<b>Rediwall® Temporary Construction Bracing</b>	<b>85</b>
		Bracing of Walls .....	86
		<b>Core Filling of Walls</b>	<b>94</b>
		<b>SCC Construction Details</b>	<b>99</b>

## Legal Statements

### Important Legal Statements

Reasonable efforts have been made to ensure the accuracy of this publication; however, any information or data contained herein is subject to change without notice. To ensure the information you are using is correct, AFS recommends you review the latest technical information available on the AFS website [www.afsformwork.com.au](http://www.afsformwork.com.au), or alternatively call 1300 727 237 to speak to a Technical Representative.

The AFS logo and rediwall® mark are registered trade marks. © 2020 AFS SYSTEMS PTY LTD. No part of this publication may be reproduced in any form or by any means without prior written permission from AFS Systems Pty Ltd. All rights reserved.



### Disclaimer

The products referred to in this document have been manufactured by or on behalf of CSR Building Products Limited ("CSR") to comply with the Building Code of Australia and any relevant Australian Standards. While any design or usage guidelines set out in this document have been prepared in good faith by CSR, they are of a general nature only and are intended to be used in conjunction with project specific design and engineering advice.

It is the responsibility of the customer to ensure that CSR's products are suitable for their chosen application, including in respect of project-specific matters such as, but not limited to structural adequacy, acoustic, fire resistance/combustibility, thermal, and weatherproofing requirements. All information relating to design/installation/application of these products is offered without warranty and no responsibility can be accepted by CSR for errors and omissions, or for any use of the relevant products not in accordance with CSR's technical literature or any other relevant industry standards. For current technical and warranty documentation relating to CSR's products, visit the AFS website at [www.afsformwork.com.au](http://www.afsformwork.com.au)

# Introduction

This Installation Guide forms part of a comprehensive afs rediwall® Design Guide (Vol1, Vol2 & Vol 3) which includes chapters dedicated to Design, Performance, Compliance, Construction, Finishes and Installation of Rediwall. This Guide should be read in conjunction with Vol 1 & Vol 2. Downloads of these chapters are available via the Resource Centre at [www.afsformwork.com.au](http://www.afsformwork.com.au).

Our innovative afs rediwall® fibre cement, and afs rediwall® pvc permanent formwork walling systems have enabled the speedy and cost-efficient installation of load-bearing walls across a range of projects including multi-residential, hotels, aged care facilities, shopping centres and student accommodation.

No matter what the application from the basement right through to the penthouse, we have a comprehensive walling solution to meet the demands of any project as only AFS is able to offer you the versatility of both a fibre cement or pvc walling solution.

Our rediwall® pvc system's extruded components simply snap or slide together to create a concrete formwork erected with maximum efficiency. Rediwall® requires almost no machinery-aided installation. In fact, installations can be undertaken without the need for any detailed training. And with its high quality semi-gloss finish it requires no additional finishing for most applications.

Suitable as a tough load bearing solution for building subterranean structures such as basements and retention tanks, it can also be utilized for above ground applications such as party walls, columns and retaining walls, making it a truly versatile solution.



## Backed by one of Australia's most trusted brands

AFS Systems is a division of CSR Building Products Limited, one of Australia's leading building products companies.

We form part of CSR's portfolio of trusted brands - amongst some of the biggest names in the Australasian building products industry.



**smarter  
permanent  
formwork.™**

# System Overview

AFS Rediwall® systems provide loadbearing wall solutions for residential or commercial structures and multi storey buildings. These systems can be used for both above and below ground structures. The rediwall®

systems are highly modular, providing architects and engineers the freedom to design buildings to suit various applications.

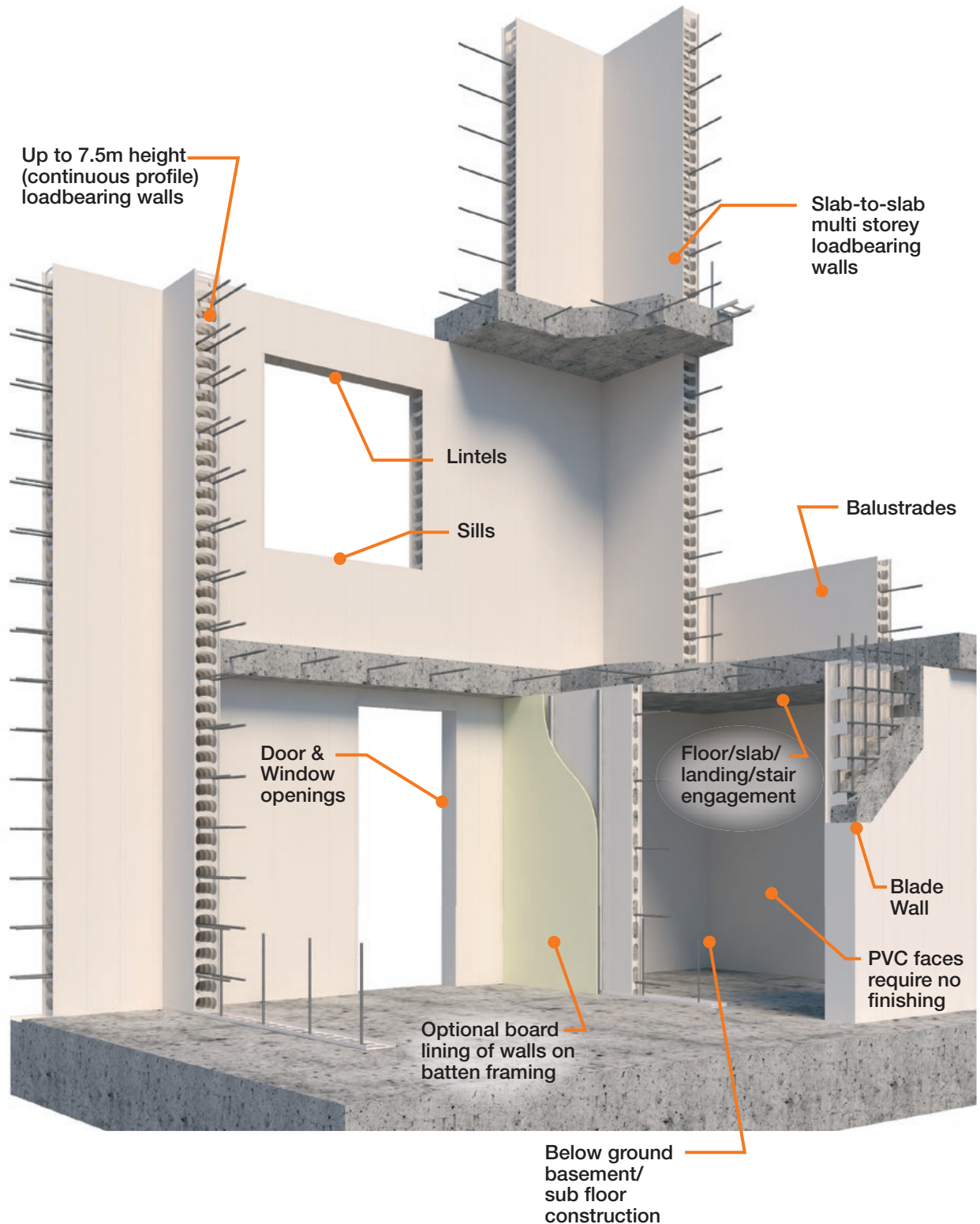

Note: If rediwall® is exposed to UV, appropriate protective finish shall be applied.

**Rediwall®  
Party walls**

**Rediwall®  
Boundary walls**

**Rediwall®  
Corridor walls**

**Rediwall®  
Balustrades**

**Rediwall®  
Garden/Landscape  
walls**

**Rediwall®  
Retention Tanks**

**Rediwall®  
Basement walls**







**Rediwall®  
Façade walls**

**Rediwall®  
Balustrades**

**Rediwall®  
Blade walls**

**Rediwall®  
Lift & Stair shafts**

**Rediwall®  
Retaining walls**

**Rediwall®  
Blade Columns**

## Rediwall® Product Description

Rediwall® consists of extruded rigid PVC components that serve as a permanent formwork for cast in-situ concrete walls for a large range of applications. The extruded components slide and snap together to create a PVC formwork that remains in place after the concrete is poured and cured, providing a low maintenance, finished wall surface.

The AFS Rediwall® system allows for the panels to be installed from the concrete slab which accommodates the vertical walls being built prior to the horizontal formwork being installed

The available rediwall® types are identified in the following table:

**TABLE C1: Rediwall® Systems Overview**

AFS Rediwall®		OVERALL THICKNESS (NOMINAL)	CONCRETE CORE (INTERNAL CAVITY)	FILLED MASS (kg/m <sup>2</sup> )	UNFILLED MASS (kg/m <sup>2</sup> )	PVC WALL THICKNESS (mm)
Clip System	RW110C	110mm	105mm	257	9.3	2.4
	RW156C	156mm	151mm	367	9.9	2.4
	RW200C	200mm	195mm	472	10.4	2.4
Slide System	RW256S	256mm	251mm	606	12.1	2.4
	RW275S	275mm	270mm	651	11.8	2.5
	RW300S	300mm	295mm	711	12.8	2.5





## Rediwall® System Benefits



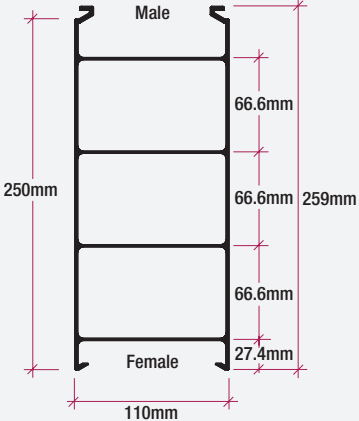
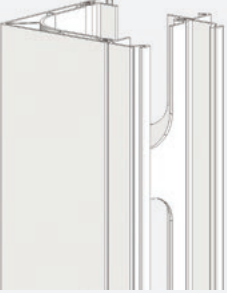
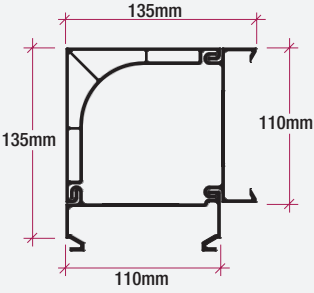
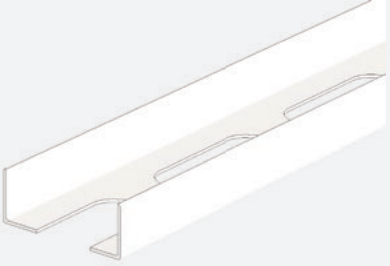

With an increasing demand throughout the construction industry for faster and more efficient building methods, rediwall® has gained rapid acceptance in the market place due to the range of benefits it offers developers, designers and builders, including:

- Cost efficiency
- Speed of construction
- Ease of installation and materials handling
- Low maintenance and aesthetically appealing finish
- NCC compliant
- Water resistant
- Design versatility



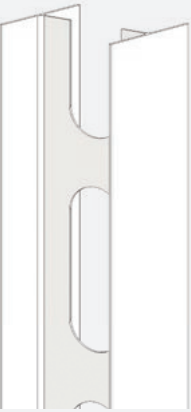
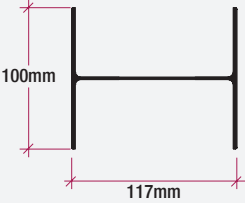



# Components, Tools & Accessories

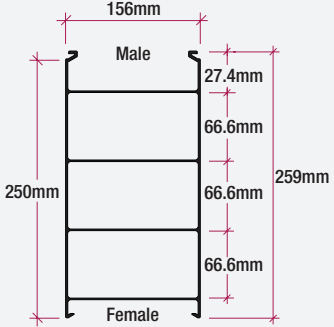

## Components for RW110C System

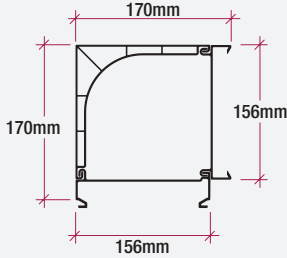

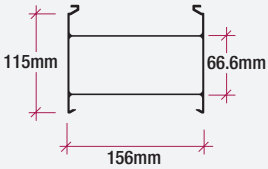
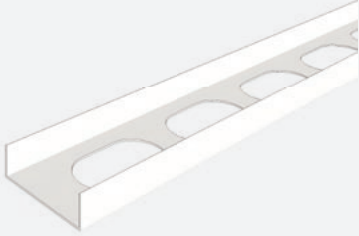
RW110C Panel		Description
		An extruded PVC panel used to form the main body of a wall. Adjoining panels are fitted using the male to female clip-in system. Each panel is extruded to a surface tolerance of 1.5mm. Has 4 internal webs with oval holes for single reo bar placement. For m <sup>2</sup> calculation, face width is 250mm.
RW110C Corner Assembly		Description
		A three piece PVC panel that forms a corner between walls meeting at 90°. Designed to allow for removal of the outside 90° corner cap for easy placement and inspection of internal reinforcement. Cap is refitted for concrete filling. Adjoining panels are fitted using the male to female clip-in system.
Floor Track		Description
		A PVC track used to set the bottom line of the wall. Laid flat, the floor track has large holes for starter bars, etc. The sides are for both locating the panels and for screw fixing to the bottom of the panels. Also used as an alternative to a T-joiner in tee junction arrangements.
T joiner		Description
		A PVC extrusion used to start a T-wall from a through wall, where the T-wall is close to 90°. Fixed vertically to the face of the through wall. Has holes in its face to assist alignment when drilling the through wall for reo bar placement. Adjoining panels are fitted using the male to female clip-in system.

H joiner		Description
		<p>A slide-on PVC extrusion.</p> <p>Primarily used horizontally on external walls where it is laid along the straightened top of panels to act as a bottom track for the next level of panels.</p> <p>Also used vertically as a wall make-up piece. Can be slid into a gap in the wall of 50mm or less and screw fixed to adjoining panels.</p>
Slide on End Cap		Description
		<p>A slide-on PVC extrusion for capping off wall ends and openings. Fixed on each side with screws and/or glue. Can be installed before or after wall is filled. Adequate bracing must be provided.</p>
Fibre Cement Strip		Description
		<p>A fibre cement strip, for closing off wall ends, where a simple shutter is required. Cut to length on-site, the strip slides in behind the female clip end of the panel (or alternatively behind a web). Can also be use as a pour break. Adequate bracing must be provided.</p>

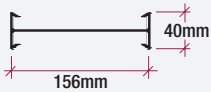
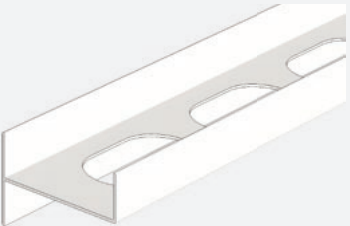
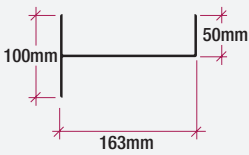
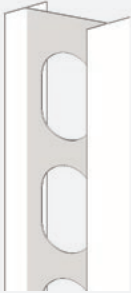
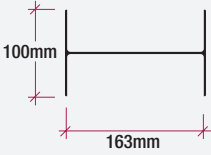

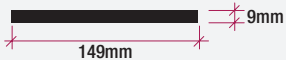

## Components for RW156C System

RW156C Panel	Description	Description
		<p>An extruded PVC panel used to form the main body of a wall. Adjoining panels are fitted using the male to female clip-in system. Each panel is extruded to a surface tolerance of 1.5mm. Has 4 internal webs with oval holes for single reo bar placement. For m<sup>2</sup> calculation, face width is 250mm.</p>
RW156C Corner Assembly	Description	Description
		<p>A three piece PVC panel that forms a corner between walls meeting at 90°. Designed to allow for removal of the outside 90° corner cap for easy placement and inspection of internal reinforcement. Cap is refitted for concrete filling. Adjoining panels are fitted using the male to female clip-in system.</p>
115mm Spacer	Description	Description
		<p>An extruded PVC panel used to adjust the length of a wall. Adjoining panels are fitted using the male to female clip-in system. Used primarily close to the closure of a wall, Has 2 internal webs with oval holes for single reo bar placement. For m<sup>2</sup> calculation, face width is 115mm.</p>
Floor Track	Description	Description
		<p>A PVC track used to set the bottom line of the wall. Laid flat, the floor track has large holes for starter bars, etc. The sides are for both locating the panels and for screw fixing to the bottom of the panels. Also used as an alternative to a T-joiner in tee junction arrangements.</p>



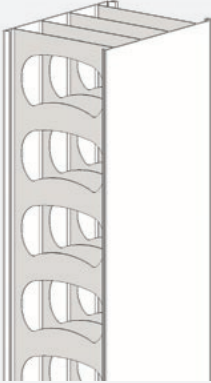
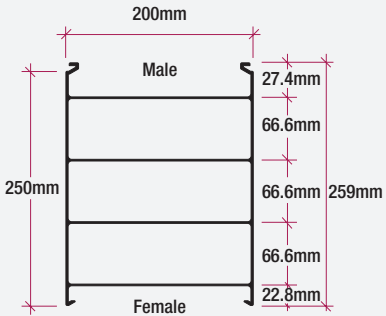

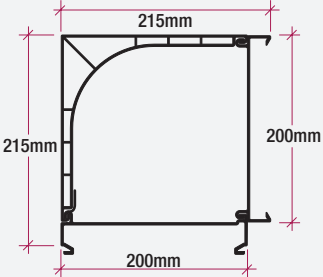
Female/Female Joiner		Description
		An extruded PVC joiner used to reverse a male panel end to a female panel end. For m <sup>2</sup> calculation, face width is 40mm.
J Track		Description
		A slide-on PVC extrusion primarily used horizontally on external walls where an edge-form slab is to be formed. It is laid along the straightened top of panels to act as a bottom track for the next level of panels and to assist with edge-form preparation.
H Joiner		Description
		A slide-on PVC extrusion primarily used horizontally on external walls where it is laid along the straightened top of panels to act as a bottom track for the next level of panels.  Also used vertically as a wall make-up piece. Can be slid into a gap in the wall of 50mm or less and screw fixed to adjoining panels.
T Joiner		Description
		A PVC extrusion that is fixed vertically to the face of a through wall to start a T-wall, where the T-wall is close to 90°. Has holes in its face to assist alignment when drilling the through wall for reo bar placement. Adjoining panels are fitted using the male to female clip-in system.

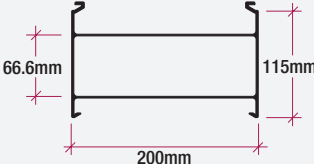
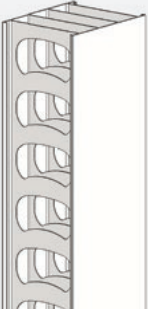
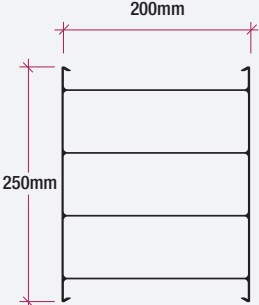



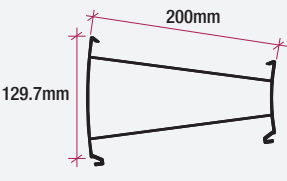
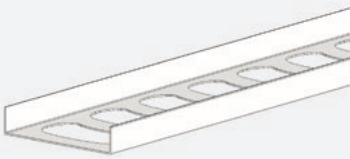

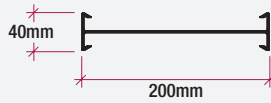
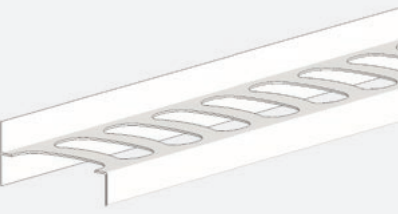
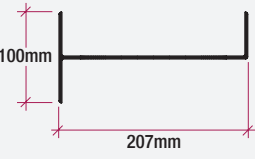
Slide on End Cap		Description
		<p>A slide-on PVC extrusion for capping off wall ends and openings. Fixed on each side with screws and/or glue. Can be installed before or after wall is filled. Adequate bracing must be provided.</p>
Fibre Cement Strip		Description
		<p>A fibre cement strip, for closing off wall ends, where a simple shutter is required. Cut to length on-site, the strip slides in behind the female clip end of the panel or joiner (or alternatively behind a web). Can also be use as a pour break. Adequate bracing must be provided.</p>

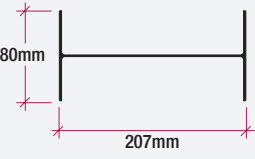
Components for RW200C System





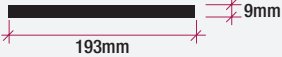

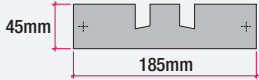

RW200C Panel	Description	Description
		<p>An extruded PVC panel used to form the main body of a wall. Adjoining panels are fitted using the male to female clip-in system. Each panel is extruded to a surface tolerance of 1.5mm. Webs have kidney shaped holes for single, or double reo bar placement by inverting the panel. Holes must be kept in horizontal alignment. For m<sup>2</sup> calculation, face width is 250mm.</p>
RW200C Corner Assembly	Description	Description
		<p>A three piece PVC panel that forms a corner between walls meeting at 90°. Designed to allow for removal of the outside 90° corner cap for easy placement and inspection of internal reinforcement. Cap is refitted for concrete filling. Adjoining panels are fitted using the male to female clip-in system.</p>
115mm Spacer	Description	Description
		<p>An extruded PVC panel used to adjust the length of a wall. Adjoining panels are fitted using the male to female clip-in system. Used primarily close to the closure of a wall. Has 2 internal webs with kidney shaped holes for single, or double reo bar placement by inverting the panel. For m<sup>2</sup> calculation, face width is 115mm.</p>
FF (Female-Female) Panel	Description	Description
		<p>An extruded PVC panel used to reverse the ends of a panel section. Particularly useful during column construction when fibre cement end caps are required. Reversing the panel end results in a female end being present at both ends of the column, allowing for the installation of neat fibre cement end caps.</p>

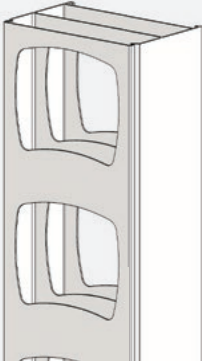

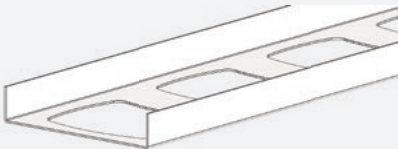

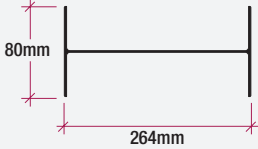

15° Curved Wall Panel		Description
		An extruded PVC panel used to form curved walls. Each panel produces a 15° curve. Adjoining panels, either the 115mm spacer or additional curved panels are added to create walls of the required radius between 0.7m to 4.8m.
Floor Track		Description
		A PVC track used to set the bottom line of the wall. Laid flat, the floor track has large holes for starter bars, etc. The sides are for both locating the panels and for screw fixing to the bottom of the panels. Also used as an alternative to a T-joiner in tee junction arrangements.
Female/Female Joiner		Description
		An extruded PVC joiner used to reverse a male panel end to a female panel end. For m <sup>2</sup> calculation, face width is 40mm.
J Track		Description
		A slide-on PVC extrusion primarily used horizontally on external walls where an edge-form slab is to be formed. It is laid along the straightened top of panels to act as a bottom track for the next level of panels and to assist with edge-form preparation.
H Joiner		Description
		A slide-on PVC extrusion. Primarily used horizontally on external walls where it is laid along the straightened top of panels to act as a bottom track for the next level of panels.  Also used vertically as a wall make-up piece. Can be slid into a gap in the wall of 38mm or less and screw fixed to adjoining panels.

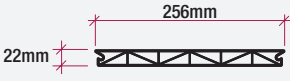

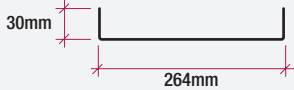

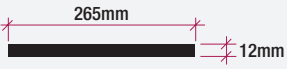
T Joiner	Description
	 <p>A PVC extrusion that is fixed vertically to the face of a through wall to start a T-wall, where the T-wall is close to 90°. Has holes in its face to assist alignment when drilling the through wall for reo bar placement. Adjoining panels are fitted using the male to female clip-in system.</p>
Slide on End Cap	Description
	 <p>For capping off wall ends and openings. A slide on connection with a 30mm side for fixing with screws or glue. Can be installed before or after wall is filled. Must be propped when filling, if a flat end is required.</p>
Fibre Cement Strip	Description
	 <p>A fibre cement strip, for closing off wall ends, where a simple shutter is required. Cut to length on-site, the strip slides in behind the female clip end of the panel or joiner (or alternatively behind a web). Can also be use as a pour break. Adequate bracing must be provided.</p>
VBL- Vertical bar locator	Description
	 <p>An accessory to ensure that vertical reinforcement is positively located within AFS walls.</p>

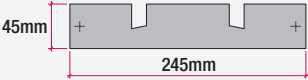

## Components for RW256S System

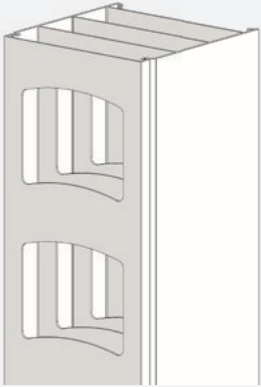
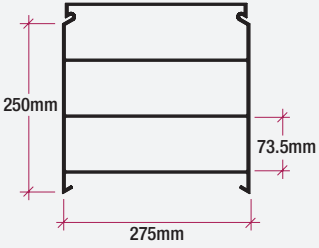
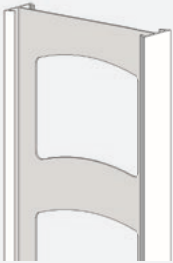
RW256S Panel		Description
		An extruded PVC panel used to form the main body of a wall. Adjoining panels are fitted using the male to female slide in coupling system. Each panel is extruded to a surface tolerance of 1.5mm. Webs have arched rectangular holes to accept double reo with appropriate concrete cover. Panels are joined by male to female slide in coupling. For m <sup>2</sup> calculation, face width is 150mm.
Floor Track		Description
		A PVC track used to set the bottom line of the wall. Laid flat, the floor track has large holes for starter bars, etc. The sides are for both locating the panels and for screw fixing to the bottom of the panels.
H Joiner		Description
		A slide-on PVC extrusion. Primarily used horizontally on external walls where it is laid along the straightened top of panels to act as a bottom track for the next level of panels.  Also used vertically as a wall make-up piece. Can be slid into a gap in the wall of 38mm or less and screw fixed to adjoining panels.
Female/Female Joiner		Description
		An extruded PVC joiner used to reverse a male panel end to a female panel end. For m <sup>2</sup> calculation, face width is 42mm.
Quick Cap		Description
		A slide-on PVC extrusion for capping off wall ends and openings. Adequate bracing must be provided.

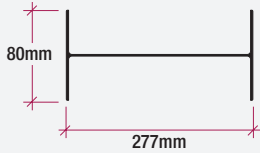

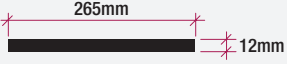

Slide On End Cap		Description
		<p>A slide-on PVC extrusion for capping off wall ends and openings. Adequate bracing must be provided.</p>
Fibre Cement Strip		Description
		<p>A fibre cement strip, for closing off wall ends, where a simple shutter is required. Cut to length on-site, the strip slides in behind the web of an end panel. Can also be use as a pour break. Adequate bracing must be provided.</p>
VBL- Vertical bar locator		Description
		<p>An accessory to ensure that vertical reinforcement is positively located within AFS walls</p>

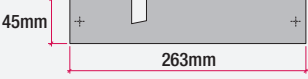

## Components for RW275S System

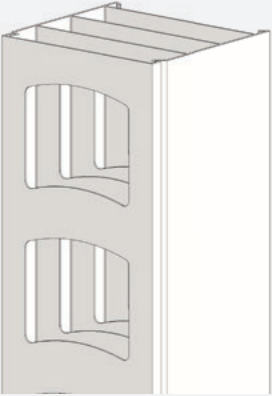
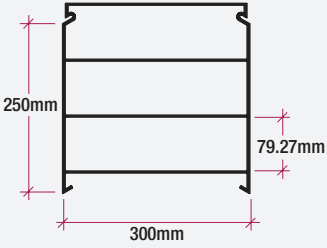
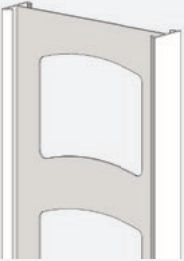
RW275S Panel		Description
		<p>An extruded PVC panel used to form the main body of a wall. Adjoining panels are fitted using the male to female slide in coupling system. Each panel is extruded to a surface tolerance of 1.5mm. Has 4 internal webs with arched rectangular holes for double reo bar with appropriate concrete cover. For m<sup>2</sup> calculation, face width is 250mm.</p>
Female/Female Joiner		Description
		<p>An extruded PVC joiner used to reverse a male panel end to a female panel end. For m<sup>2</sup> calculation, face width is 65mm.</p>
H Joiner		Description
		<p>A slide-on PVC extrusion. Primarily used horizontally on external walls where it is laid along the straightened top of panels to act as a bottom track for the next level of panels.</p> <p>Also used vertically as a wall make-up piece. Can be slid into a gap in the wall of 38mm or less and screw fixed to adjoining panels.</p>
Slide On End Cap		Description
		<p>A slide-on PVC extrusion for capping off wall ends and openings. Adequate bracing must be provided.</p>

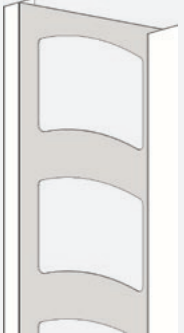
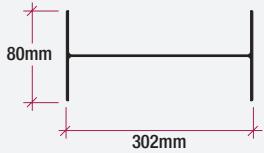
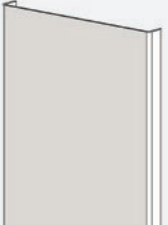
Fibre Cement Strip		Description
		A fibre cement strip, for closing off wall ends, where a simple shutter is required. Cut to length on-site, the strip slides in behind the web of an end panel. Can also be use as a pour break. Adequate bracing must be provided.
VBL- Vertical bar locator		Description
		An accessory to ensure that vertical reinforcement is positively located within AFS walls



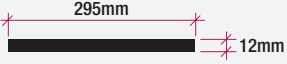

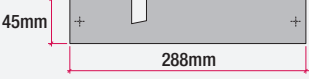
## Components for RW300S System

RW300S Panel		Description
		<p>An extruded PVC panel used to form the main body of a wall. Adjoining panels are fitted using the male to female slide in coupling system. Each panel is extruded to a surface tolerance of 1.5mm. Has 4 internal webs with arched rectangular holes for double reo bar with appropriate cover. For m<sup>2</sup> calculation, face width is 250mm.</p>
Female/Female Joiner		Description
		<p>An extruded PVC joiner used to reverse a male panel end to a female panel end. For m<sup>2</sup> calculation, face width is 65mm.</p>
H Joiner		Description
		<p>A slide-on PVC extrusion. Primarily used horizontally on external walls where it is laid along the straightened top of panels to act as a bottom track for the next level of panels.</p> <p>Also used vertically as a wall make-up piece. Can be slid into a gap in the wall of 38mm or less and screw fixed to adjoining panels.</p>
Fibre Cement Strip		Description
		<p>A slide-on PVC extrusion for capping off wall ends and openings. Adequate bracing must be provided.</p>

Fibre Cement Strip		Description
		A fibre cement strip, for closing off wall ends, where a simple shutter is required. Cut to length on-site, the strip slides in behind the web of an end panel. Can also be use as a pour break. Adequate bracing must be provided.
VBL- Vertical bar locator		Description
		An accessory to ensure that vertical reinforcement is positively located within AFS walls

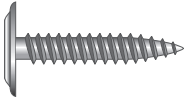

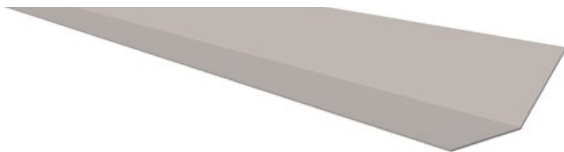
## Tools & Accessories

Screws	Description
	Button head stitching screw 10G x 25mm, for joining of rediwall® components.
Wall Brace	Description
	Adjustable wall bracing is available from AFS for purchase. Contact afs for further information.
Squint Angle	Description
	Powder coated metal squint angle 150 x 150mm at 135° Used to form 45° wall corners.
Floor Angle	Description
	Galvanised metal floor angle 50 x 50mm at 90°. Used to set the bottom line of the wall. Laid flat, and set at a distance apart to match the wall sized used. The sides are for both locating the panels and for screw fixing to the bottom of the panels
Internal Corner Angle	Description
	Galvanised metal internal corner connection angle 30 x 30mm at 90°. Used in to connect the RW256/RW275/ RW300 open corner panels assemblies at the internal corner junction. The angle is screwed to the male ends of the panels.

## Workplace Health Safety and the Environment

AFS rediwall® has been designed with workplace health safety and the environment in mind. Issues regarding installation have been considered so that the risk of harm to those who build, use and maintain the structure is minimised.

A vital consideration when planning installation, is to have appropriate safe systems of work to identify hazards, assess risks, control exposures and to ensure a process is in place to review control measures.

Assessing the hazards associated with the installation methods, equipment, tools, dust, noise, chemicals, other trades and work environment is the responsibility of both the builder and installer.

Appropriate assessment of risk, adequate resources, communication methods and training provided to workers is to be considered and documented for each site location.

### Personal Protective Equipment

The Personal Protective Equipment (PPE) required may vary from site to site and from time to time, and it is the responsibility of every individual to ensure that they use the appropriate equipment to safeguard themselves and those around them.

Rediwall® panels and concrete contain silicas that are harmful if inhaled. Appropriate protective clothing and breathing equipment must be worn when cutting rediwall®.

When cutting, drilling, screwing or grinding panels using power tools, an attached LEV and a M or H Class HEPA filter industrial vacuum must be used.

#### **Always ensure the work area is properly ventilated.**

An approved P2 half face mask and safety glasses must be worn. AFS recommends that hearing protection be worn if equipment used exceeds noise standards.

### Recommended Safe Working Practices

#### Cutting Outdoors

- Position cutting station so wind will blow dust away from the user or others in the working area.
- Use a dust reducing plunge saw equipped with a dust extract ion system . (LEV and a M or H Class HEPA filter)

#### Sanding/Drilling/Screwing/Other Machining

- When sanding, drilling, screwing or machining, you should always wear a P2 half face mask. **(provides 10 x protection from dust inhalation)**
- Fit check and fit test your respirators to get full protection.
- Replace your mask (or filter components) more often if heavy dust.
- Warn others in the immediate area to move away or wear suitable PPE.

### Important Reminders

**NEVER** use a power saw indoors without adequate ventilation and PPE.

**NEVER** use a saw blade that is not purpose-made for cutting PVC, fibre cement, concrete and steel products.

**NEVER** dust generation by either vacuuming or wet sweeping.

**NEVER** dry sweeping - only with adequate ventilation and PPE.

**ALWAYS** wear recommended PPE.

**ALWAYS** follow tool manufacturers' safety recommendations.

**ALWAYS** be aware of others in your working location.

These control measures are consistent with industry recommendations for safe work practices. Assessments have proven, this combination will reduce the airborne concentration of RCS to levels below the exposure standard for workers .

AFS has documented sample safe work methods that can be accessed upon request as REFERENCE MATERIAL ONLY. This can be provided as an aid to builders and installers when risk assessing the work, and when developing their own documentation.

Consultation and training of workers in agreed safe methods will always be the builders and installers responsibility.

Safety Data Sheets are available upon request at [www.afsformwork.com.au](http://www.afsformwork.com.au)

For further information please visit SafeWork Australia <https://www.safeworkaustralia.gov.au/risk>

## Hand Tools Required

To safely and efficiently complete any task, it is essential to have the necessary tools available and to use the right tool for the right task.

A typical range of hand tools would include, but not be limited to the following:

- Tool bag/belts
- Cutting knife
- Handsaws
- Hammers - 'claw' and 'gympie'
- Pencils, marking pens, chalk
- Variety of pliers
- A range of squares
- String and chalk lines
- Tape Measures – eg. 8m and 3m
- Spirit levels – range of lengths eg. 600mm and 2000mm
- Plumb Bob
- Laser leveling equipment



## Access Tools

All scaffolding and safe access provisions are the responsibility of the builder and installers and are governed by the individual site conditions. It is essential that safe work practices and all associated standards are met/complied with. Installers would normally provide a range of platforms for personal access to the top of wall panels for the fitting of braces and checking of stringlines.

## Power Tools

There are a range of power tools required during installation of afs rediwall®. Wherever possible preference should be given to cordless tools.

Note: All power tools require tagging as per site requirements.

Suggested power tools and applications include:

- A 'charge gun', such as the 'Hilti GX120' with appropriate fixings to pin the floor track to the concrete slab.



Hilti GX120

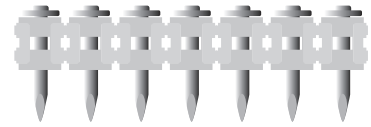

- A screw driver gun, with appropriate driver bits and screws for fixing rediwall® panels to track and adjacent panels or form deck. Also used to fixing bracing.



- A range of grinders and circular saws for cutting components and timbers for bracing.



## Concrete Pouring & Finishing Tools

- Concrete pouring and finishing tools, including:
  - At least one wheelbarrow, multiple shovels and a range of trowels.
  - Concrete vibrator: 38mm diameter maximum.



# The Construction Process

## Construction Process Overview

### 1 Place Order

Client completes rediwall® order form, listing lineal metres of each wall height required, and selecting any accessories required. The completed order form is submitted to [afsorders@csr.com.au](mailto:afsorders@csr.com.au) electronically or by fax on 1300 715 237.

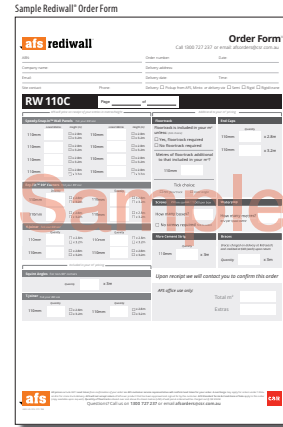

Sample Rediwall® Order Form

**afs rediwall** Order Form™  
Call 1300 715 237 or email [afsorders@csr.com.au](mailto:afsorders@csr.com.au)

Company Name: \_\_\_\_\_  
 Street Address: \_\_\_\_\_  
 Suburb: \_\_\_\_\_  
 State: \_\_\_\_\_  
 Postcode: \_\_\_\_\_  
 Phone: \_\_\_\_\_  
 Email: \_\_\_\_\_

**RW 110C**

Line	Height (m)	Length (m)	Accessories	Notes
1	1.10	10.00	Standard	
2	1.10	10.00	Standard	
3	1.10	10.00	Standard	
4	1.10	10.00	Standard	
5	1.10	10.00	Standard	
6	1.10	10.00	Standard	
7	1.10	10.00	Standard	
8	1.10	10.00	Standard	
9	1.10	10.00	Standard	
10	1.10	10.00	Standard	
11	1.10	10.00	Standard	
12	1.10	10.00	Standard	
13	1.10	10.00	Standard	
14	1.10	10.00	Standard	
15	1.10	10.00	Standard	
16	1.10	10.00	Standard	
17	1.10	10.00	Standard	
18	1.10	10.00	Standard	
19	1.10	10.00	Standard	
20	1.10	10.00	Standard	

**Summary**

Total m<sup>2</sup>: \_\_\_\_\_  
 Extras: \_\_\_\_\_

**afs** **CSL**

### 2 Production

AFS Rediwall® is manufactured in a state of the art factory with precision processes, manufacturing large volumes of quality product with short lead times.

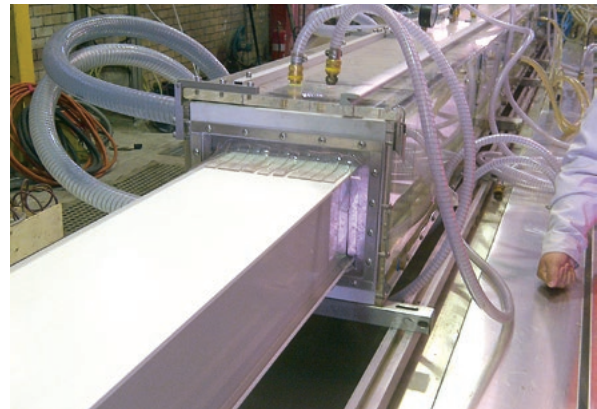

### 3 Delivery

AFS's in house transportation and logistics team ensure that orders are shipped with care, arriving on site in a timely manner. Panels are shipped in packs of up to approximately 20 panels for RW110C, 20 for 156C, 20 for RW200C 24 for RW256S, 12 for RW275S and 12 for RW300S which are easily delivered to site and craned onto the floor slab or deck ready for placement.



## Construction Process Overview – Continued

### 4 Site Erection

Once set-out is complete, rediwall® floor track is installed, followed by the rediwall® panels being lifted into place by hand over the reinforcement starter bars. In some cases it is simply installed off the formwork deck of the next floor level. The panels are then braced using temporary bracing or fixed to the formwork deck.

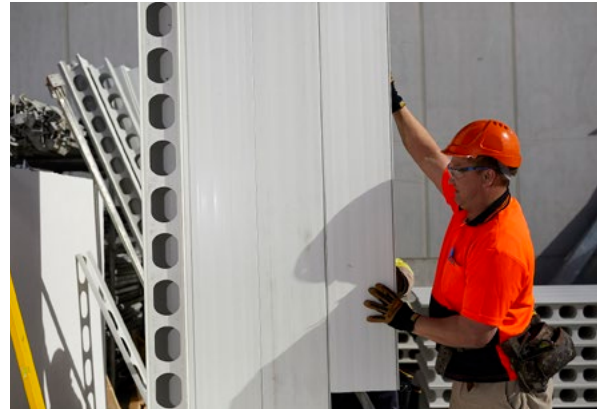

### 5 Openings & Services

Smaller penetrations may be cut out once the formwork is installed and then capped off using the rediwall® End Cap. Doorway and window openings are formed using sill and lintel panels which can be supplied cut to size. Steel door frames can be installed to suit, or the openings can simply be capped off using the rediwall® End Cap.



### 6 Concrete Core Fill

The erected panels are then core filled with concrete using a mix design that is suitable for filling rediwall®, via a concrete pump. This is mostly done from the formed deck of the next slab or off a scaffold. Refer to concrete core fill procedure.



## Construction Process Overview – Continued

### 7 Finishing of Walls

Once the concrete core fill has gained strength and the walls are permanently braced by the floor or roof structure at the top of the walls, the temporary bracing is removed. The smooth, off white finish of the rediwall® panels is a suitable finish for many applications, refer to Volume 2 – "Wall Construction Detailing & Finishing Treatments Guide" for specific finishes for rediwall®.

Suitable paints or renders can be applied to the surface if required. Please contact Dulux Acratex, Rockcote or equivalent render suppliers, for their warranted specifications on the rediwall® substrate.



## Ordering

Ordering of rediwall® is a simple process requiring a rediwall® Order Form to be completed by the appropriate project personnel and submitted to the rediwall® production team.

A sample of the form is shown below. An interactive PDF form can be downloaded from [www.afsformwork.com.au/rediwall-order-form](http://www.afsformwork.com.au/rediwall-order-form) completed digitally and then emailed to – [afsorders@csr.com.au](mailto:afsorders@csr.com.au)

Alternatively a printable form can be downloaded at [www.afsformwork.com.au/rediwall-order-form](http://www.afsformwork.com.au/rediwall-order-form) completed and returned by email as above or faxed to 1300 715 237.

Lengths and heights of walls, derived from project construction drawings, are inserted into the rediwall® order form along with the quantities of accessories, such as: corners, end caps, floor track and H-sections.

To avoid delays during erection, it is recommended that additional rediwall® components are ordered. Additional quantities ordered should be based on project size, construction schedule, site proximity to the rediwall® supply facility, the potential for damage on site and the potential for site modifications.

On completion and submission of your order form you will receive a confirmation detailing exactly what has been entered into the production system. It is the customers responsibility to check this confirmation for accuracy and advise AFS of any errors immediately.

## How to order

- 1 Complete your company details, make sure to include the correct site contact details.
- 2 Complete your order number, delivery address and your requested delivery date.
- 3 Calculate the total linear metres required and the height of the panels you require. All accessories are supplied at stock length.
- 4 Add quantities of Squint Angles and T junctions if required.
- 5 Select your floor track option and quantity.
- 6 Enter the quantity of end caps, screws, braces and fibre cement strips you will need.
- 7 Submit your form and AFS will contact you for order confirmation before processing your order. Check the confirmation email from AFS for accuracy.

## Sample Rediwall® Order Form

**afs rediwall®** Order Form<sup>v4</sup>  
Call 1300 727 237 or email: [afsorders@csr.com.au](mailto:afsorders@csr.com.au)

ABN: \_\_\_\_\_ Order number: \_\_\_\_\_ Date: \_\_\_\_\_  
 Company name: \_\_\_\_\_ Delivery address: \_\_\_\_\_  
 Email: \_\_\_\_\_ Delivery date: \_\_\_\_\_ Time: \_\_\_\_\_  
 Site contact: \_\_\_\_\_ Phone: \_\_\_\_\_ Delivery  Pickup from AFS, Mirro, or delivery via  Semi  Rigid  Rigiflex

**RW 110C** Page \_\_\_\_\_ of \_\_\_\_\_

Speedy-Snap-In™ Wall Panels <small>Enter your site size</small>				Floor Track		End Caps	
Linear Metres	Height m	Linear Metres	Height m	Floor track is included in your m <sup>2</sup> unless: (tick choice)		Quantity	Quantity
110mm	<input type="checkbox"/> x 2.8m <input type="checkbox"/> x 3.2m	110mm	<input type="checkbox"/> x 2.8m <input type="checkbox"/> x 3.2m	<input type="checkbox"/> Yes, floor track required <input type="checkbox"/> No floor track required		110mm	x 2.8m
110mm	<input type="checkbox"/> x 2.8m <input type="checkbox"/> x 3.2m	110mm	<input type="checkbox"/> x 2.8m <input type="checkbox"/> x 3.2m	Metres of floor track additional to that included in your m <sup>2</sup> :		110mm	x 3.2m
110mm	<input type="checkbox"/> x 2.8m <input type="checkbox"/> x 3.2m	110mm	<input type="checkbox"/> x 2.8m <input type="checkbox"/> x 3.2m	110mm		Screws: 25mm screws x 1,000 per box	

Ezy-Fit™ 90° Corners <small>Tick your fit size</small>				Tick choice:		How many boxes?	
Quantity	<input type="checkbox"/> x 2.8m <input type="checkbox"/> x 3.2m	Quantity	<input type="checkbox"/> x 2.8m <input type="checkbox"/> x 3.2m	<input type="checkbox"/> PVC floor track <input type="checkbox"/> Floor angle		<input type="checkbox"/> No screws required <input type="checkbox"/> Tick to select	
110mm	<input type="checkbox"/> x 2.8m <input type="checkbox"/> x 3.2m	110mm	<input type="checkbox"/> x 2.8m <input type="checkbox"/> x 3.2m	Fibre Cement Strip		Braces	
110mm	<input type="checkbox"/> x 2.8m <input type="checkbox"/> x 3.2m	110mm	<input type="checkbox"/> x 2.8m <input type="checkbox"/> x 3.2m	110mm		Quantity x 3m	

H Joiners <small>Tick your fit size</small>				Upon receipt we will contact you to confirm this order	
Quantity	<input type="checkbox"/> x 2.8m <input type="checkbox"/> x 3.2m	Quantity	<input type="checkbox"/> x 2.8m <input type="checkbox"/> x 3.2m	AFS office use only:	
110mm	<input type="checkbox"/> x 2.8m <input type="checkbox"/> x 3.2m	110mm	<input type="checkbox"/> x 2.8m <input type="checkbox"/> x 3.2m	Total m <sup>2</sup> _____	
110mm	<input type="checkbox"/> x 2.8m <input type="checkbox"/> x 3.2m	110mm	<input type="checkbox"/> x 2.8m <input type="checkbox"/> x 3.2m	Extras _____	

**Squint Angles** For non-90° corners  
Quantity \_\_\_\_\_ x 3m

**T Joiners**  
110mm Quantity \_\_\_\_\_ x 3.2m

All prices include GST. Call time from completion of your order. An AFS customer service representative will contact you to confirm your order. A postage into AFS for orders under 100kg and/or for same track delivery. AFS will not accept returns of self-over product that has been approved and signed for by the customer. AFS Standard Terms & Conditions of Sale apply to this order (only available upon request). Quantity of materials ordered can vary where the total metres (m) of each panel ordered are for charges over 2.00. © 2024.

Questions? Call us on 1300 727 237 or email [afsorders@csr.com.au](mailto:afsorders@csr.com.au)



# Construction and Installation Procedures

This Installation Procedure Section has been prepared by AFS Systems Pty Ltd to assist builders, engineers and architects to understand the construction procedures for loadbearing and retaining walls using rediwall®.

The Installation Section provides information on the following aspects of construction using rediwall®:

- Ordering
- Delivery
- Wall set-out
- Establishing installation starting point
- Floor track/floor angle installation
- Installation of 90° corner
- Screw fixing of panels to floor track
- Installation of corner reinforcement
- Horizontal reinforcement placement
- Vertical reinforcement placement
- End caps
- Curved walls
- Tanking
- Bracing

## Introduction

Although every effort has been made to ensure that all the information provided in this Installation manual is factual and consistent with good practice, AFS does not assume any liability for errors or oversights resulting from the use of information contained in this manual.

AFS highly recommends that the entire construction team are fully aware of the construction order and methods prior to commencement of wall installation.

Rediwall® consists of extruded rigid polymer components that serve as a permanent formwork for concrete walls in loadbearing and retaining applications. Popular uses include basement walls, retaining walls, retention tanks, foundation and landscaping walls, blade walls etc. The extruded components connect together to create formwork that remains in place after the concrete is poured and cured. This combination results in a strong concrete core wall with a low maintenance, finished wall surface.

Rediwall® systems are available as shown in TABLE C2.

**TABLE C2: Rediwall® Systems Overview**

Rediwall® SYSTEM	WALL THICKNESS	
	OVERALL (NOMINAL)	CONCRETE CORE
RW110C	110mm	105mm
RW156C	156mm	151mm
RW200C	200mm	195mm
RW256S	256mm	251mm
RW275S	275mm	270mm
RW300S	300mm	295mm

Note: Concrete core thickness is calculated including manufacturing tolerance.

## Component Delivery & Worksite Layout

Transport to site is typically arranged by AFS. Rediwall® packs are unloaded by a crane or forklift (provided by the builder), or crane truck (if requested at point of sale). Customers can also pick up with their own transport if prearranged. On delivery of the rediwall® components, place the packs strategically around the area where it is to be installed to minimise manual handling. Placement of packs should not interfere with locations for temporary wall bracing required during construction.

Rediwall® panels from 600mm to 7.5m can be supplied at the requested custom heights, suited to the specific project requirements and are listed on the delivery docket received with each delivery.

Using the pins/markings provided by the surveyor and the construction drawings, ensure the walls are clearly and accurately set-out. The builder should be responsible for this and should sign off on the set-out prior to commencement.

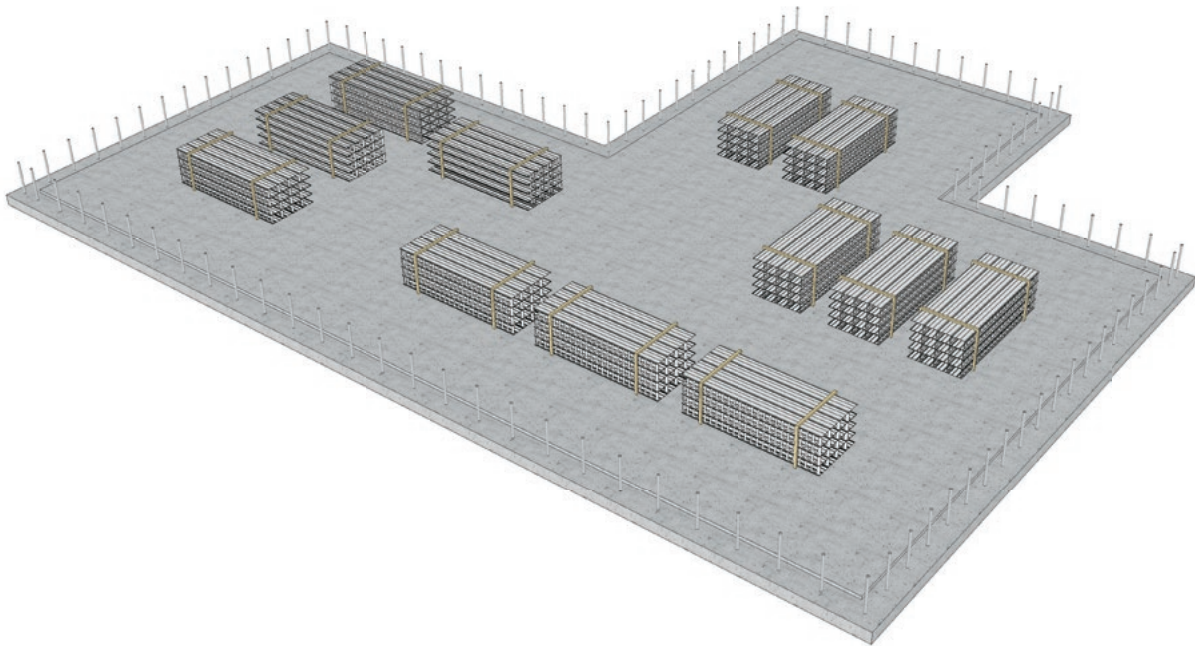

## Floor/Wall Junction – Floor Track Installation

### Introduction

Attention must be paid to the specified detailing of the horizontal slab/wall joint. Some projects have specific waterproofing requirements, such as installation of expandable Waterstop at the slab to wall junction.

**WARNING:** Rediwall® panels cannot be moved without demolition once filled with concrete.

### Base Restraint

1. A continuous horizontal member is required at the base of the wall on at least one side of the rediwall® panels to hold the members straight and to prevent movement during core filling. This member is typically PVC floor track, however a temporary 50 x 50mm steel angle (available as an accessory) can be installed on at least one side of the wall is acceptable.

2. The bottom restraining member may also act as formwork to cover any gaps at the underside of the wall due to irregularities in the surface of the footing or slab.

3. The bottom restraining member is to be fixed to the rediwall® components and anchored to the foundation as required by the Project Engineer's specifications.

4. Bottom restraining members fitted on one side of the wall are to be connected to the wall at 250mm maximum centres. For walls over 3.2m in height, the connection to the wall is to be at 150mm maximum centres.

### Rediwall® PVC Floor Track

**1** Starter bars should be set into the concrete as per engineering specifications. Corner bars should be set in the middle of the rediwall® corner profile.

**2** Mitre the ends of the floor track so that the corner joins neatly.

**3** Two beads of polyurethane sealant or as per waterproofers details, must be applied in accordance with the manufacturer's instructions under the rediwall® floor track (one on each side of the track) on all external walls, and any portion of a wall that separates or adjoins a wet area (e.g. bathroom, kitchen, or laundry).

**4** Rediwall® floor track is then placed in the required location and fixed to the concrete footing or slab using a masonry fixing gun or drill and anchor masonry fixing system. Fix with fasteners each side of the track at 250mm centres for walls up to 3.2m height, or at 150mm maximum centres for walls over 3.2m height.

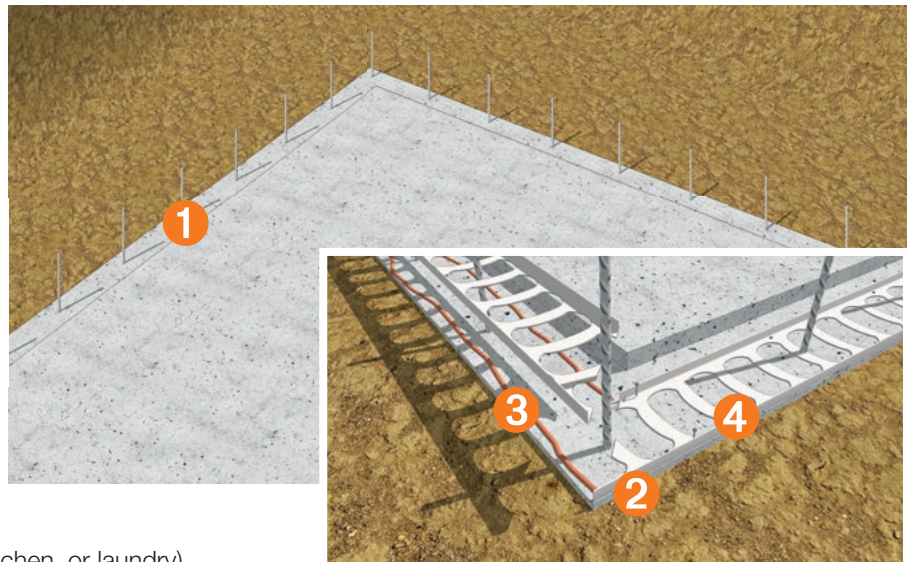

## Water Treatment of Cold Joints

All waterproofing details are to be completed by the Project Builder and waterproofing contractor. When filled with concrete, rediwall® is a water resistant wall system. However specific areas requiring waterproofing details include horizontal concrete cold joints, and where water can track down along panel joints.

Any required waterproofing products must be installed strictly in accordance with the particular manufacturer's instructions.

- 1 Install afs rediwall® floor track as per the standard installation instructions.
- 2 Use an angle grinder to cut the floor track and remove the centre web. To create a continuous clear path for the waterstop.

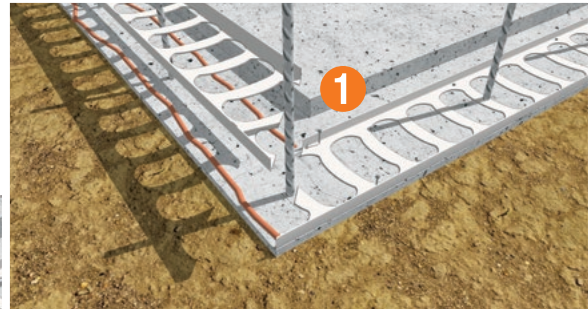
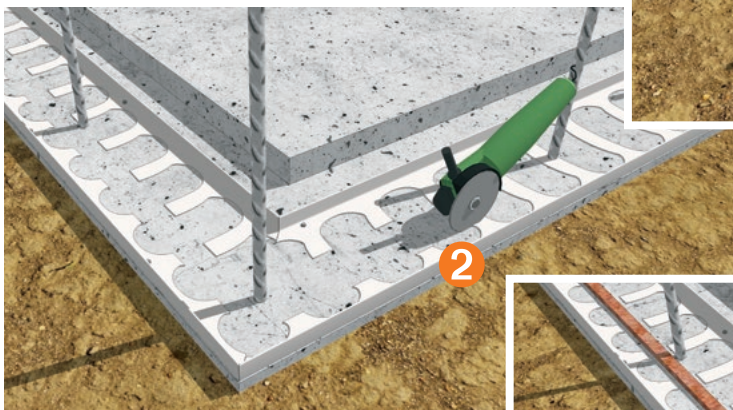

- 3 Install waterstop to manufacturer's instructions, maintaining a continuous seal. Refer to the project building designer for details on waterstop performance and installation requirements.

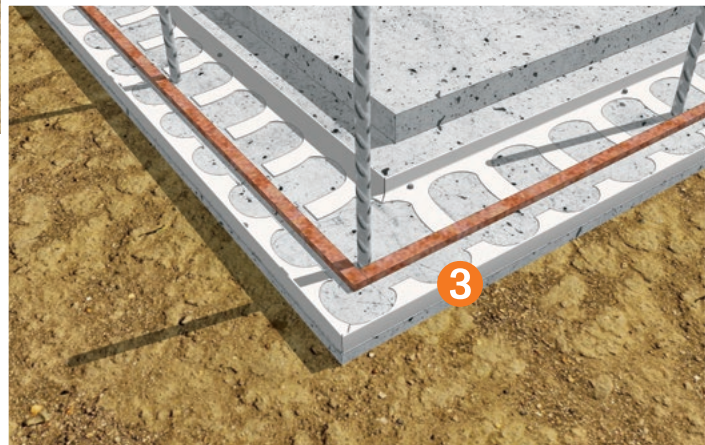

- 4 Install rediwall® panels over the water stop and fix to the floor track. Ensure that the panels DO NOT interfere with the waterstop.

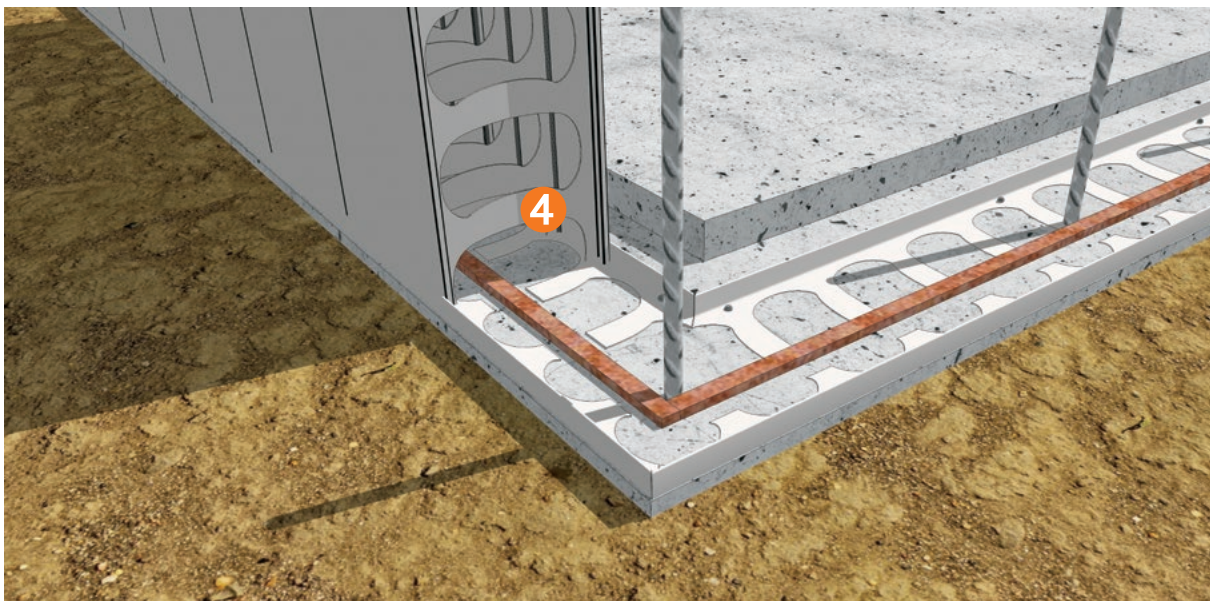

## Control Joints

### Movement Joints and Crack Control Joints

Rediwall® when completed as a structural reinforced concrete wall effectively had control joints at each web so no additional crack control joints are necessary.

Full depth "movement joints", when required, should be installed at construction stage by the rediwall installer. Refer to engineer's details for control joint locations.

- 1** Install afs rediwall® Female to Female joiner if required to reverse the panel orientation, then install a full size rediwall panel. Ensure the female to female joiner is not at the end of the wall where the fibre cement strip is required to be used.
- 2** Slide Fibre Cement Strips down behind the female end of the panel. Provide bracing across the joint with horizontal top hat brace as per the standard bracing details.
- 3** Once core fill has cured install a backing rod and fill the gap with a fire rated sealant, as per the sealant manufacturer's requirements.

NOTE: Optional doweling across the movement joint for lateral restraint can be incorporated, if required by engineer.

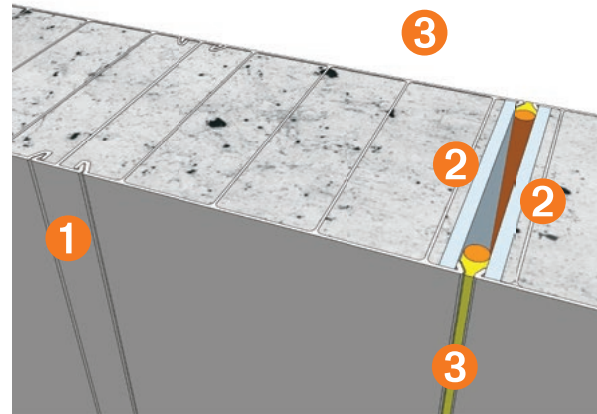

## Starting Location

### Introduction

It is important to consider the wall layout and to establish the best starting point and sequence in which to proceed with installation. This will help to ensure that the working space is kept as clear as possible.

Consideration should also be given to the positioning of bracing structures and minimising restriction of movement around the site. Refer to the Bracing section for details.

In the case of internal walls that are to be core filled off a mobile scaffold, it is preferable to run the braces in a way that leaves one face of each wall clear.

Once panel installation commences, consideration must be given to the timely installation of horizontal reinforcement.

#### WARNING

The individual components have a distinctive top and bottom orientation, which must be maintained in order for the web holes to be aligned. All panels are to be installed so that web holes are aligned horizontally.

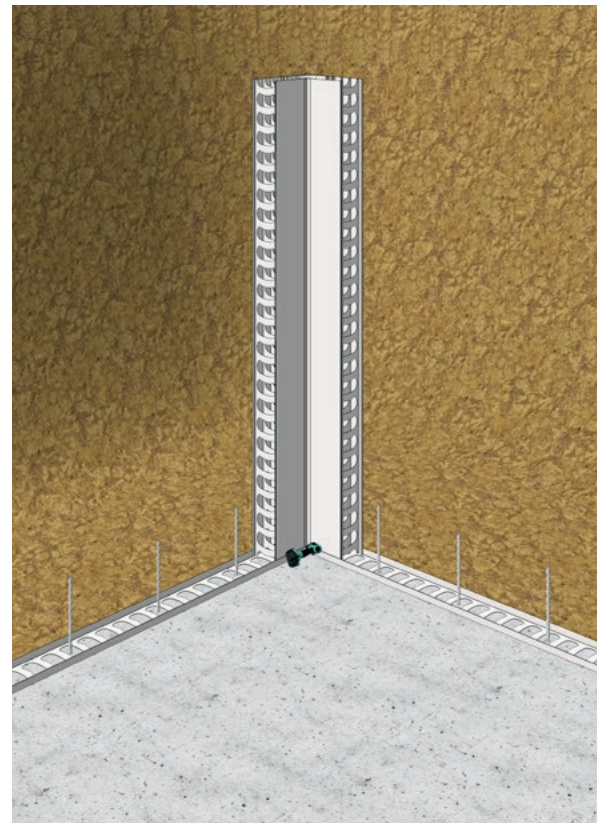

## Corner Construction

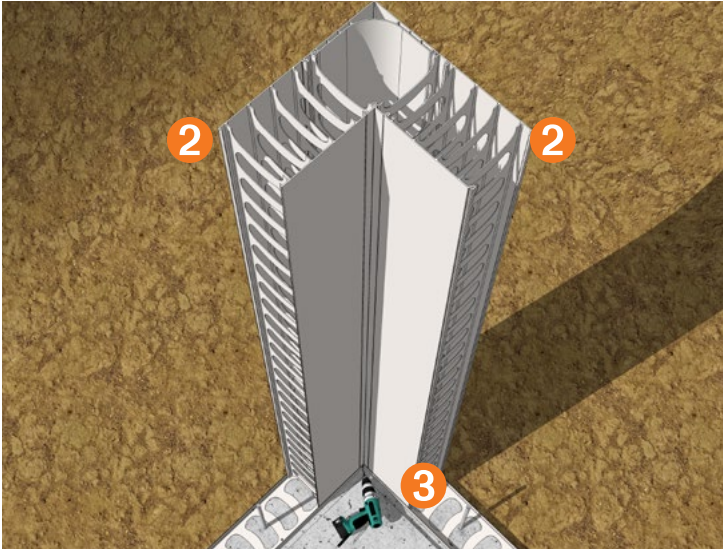
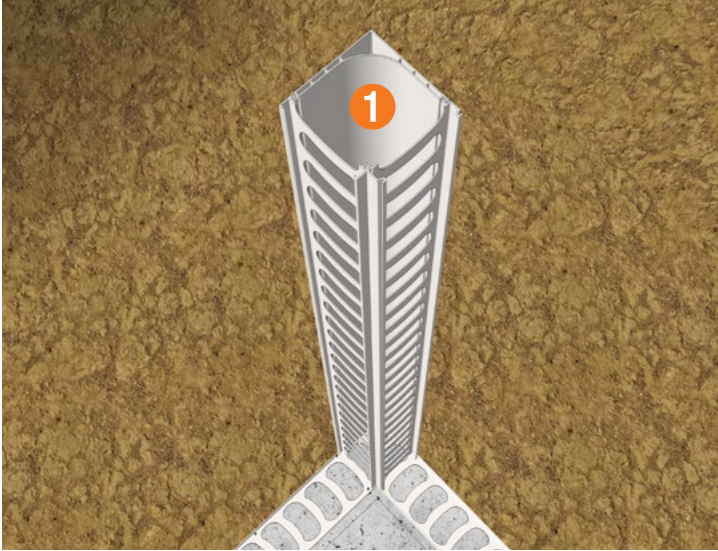

### Corner Construction

- 1** Stand the corner assembly up and position on the floor track.
- 2** Install a wall panel either side of the corner assembly.
- 3** Screw fix the panels and the corner assembly to the floor track.

## Wall Construction

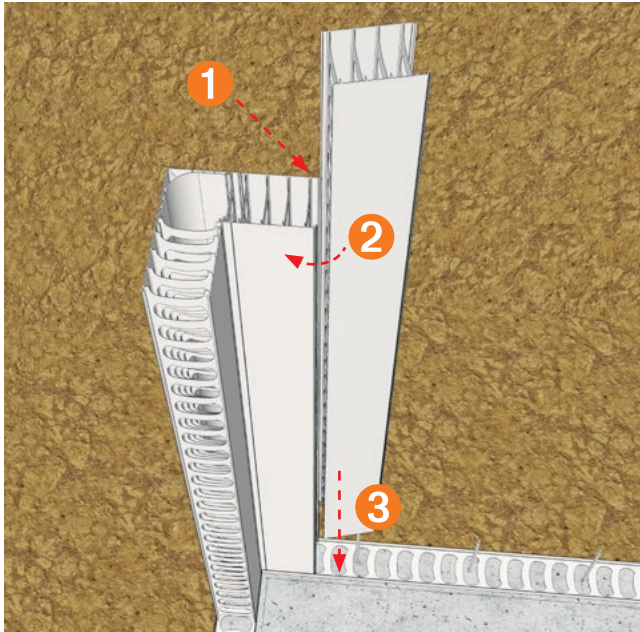

**1** From your chosen starting location, hook one side of the rediwall® panel together making sure that the panel is above the slab starter bars.

**2** Swing the rediwall® panel around and snap the opposite side into the preceding profile.

**3** Slide the assembly down over the starter bars.

**4** To avoid movement of the rediwall® panels during concrete core filling, install one screw each side of the panel through the floor track at the joint location. Ensure appropriate screw fixings are used to secure the panels.

Walls constructed using angle floor track should be fixed similarly.

**5** Continue to install panels and accessories as required to complete the wall.

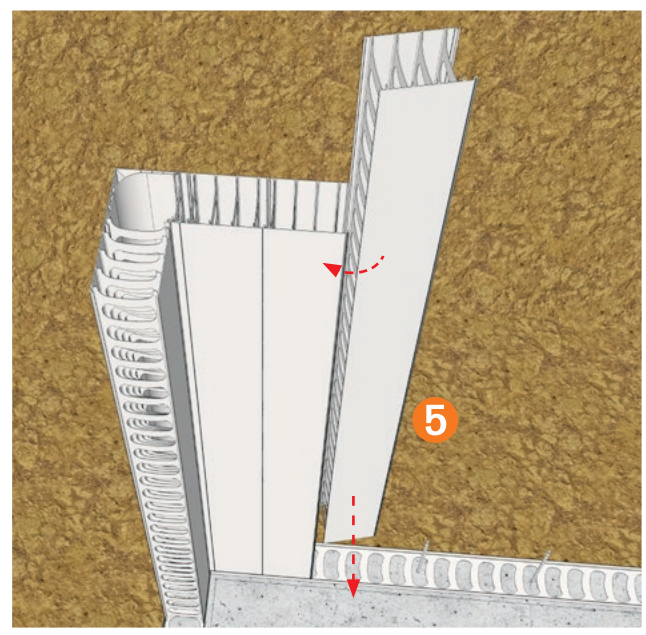
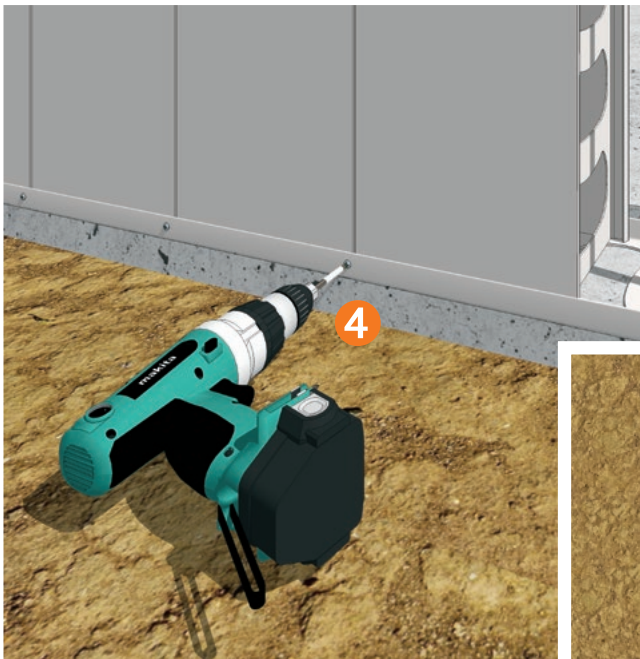

## Wall Reinforcement

Under AS3600-2018, Concrete Structures Standard, additional reinforcement requirements may be required to cater for earthquake and lateral loads as designed by the project structural engineer. This could result in specific reinforcement details to be adopted. It is important that the reinforcement be installed as per the project engineer's requirements. The following afs rediwall® reinforcement details and installation methodology has been developed to cater for the new AS3600-2018 requirements.

### Steel Reinforcement Installation – Single layer

#### Horizontal Reinforcement Installation – Single layer

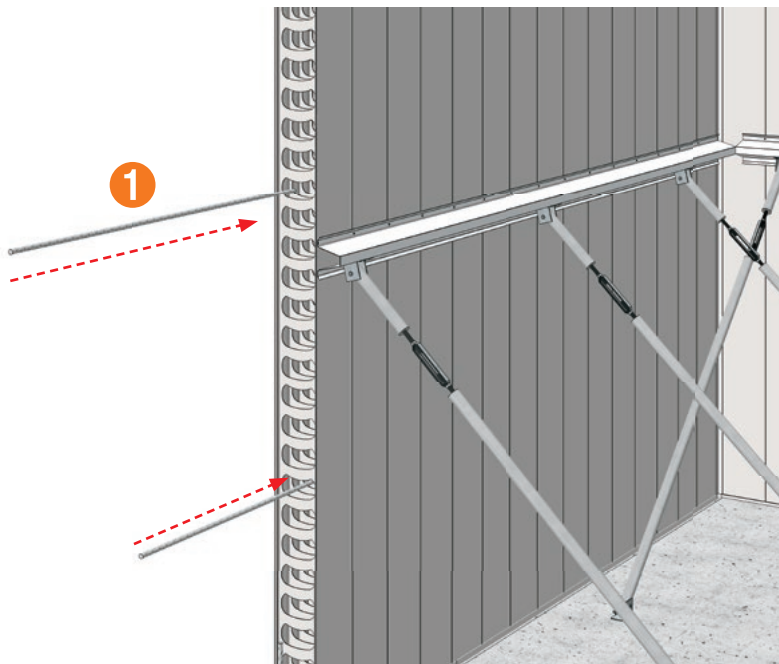

**1** Horizontal reinforcement bars should be placed into the wall when it reaches a suitable length. Generally the wall is slightly longer than the steel bar length. Slide the reinforcement bar through the rediwall® profile ensuring that the bar will maintain the correct overlap with the previous and subsequent bars where applicable.

Refer to the Project Engineer's specifications for correct overlap and spacing of reinforcing bars.

Note: When panels are installed, ensure all web holes are aligned horizontally. Damage to webs inside can result in bulges when wall is filled with concrete.

#### Vertical Reinforcement Installation – Single layer

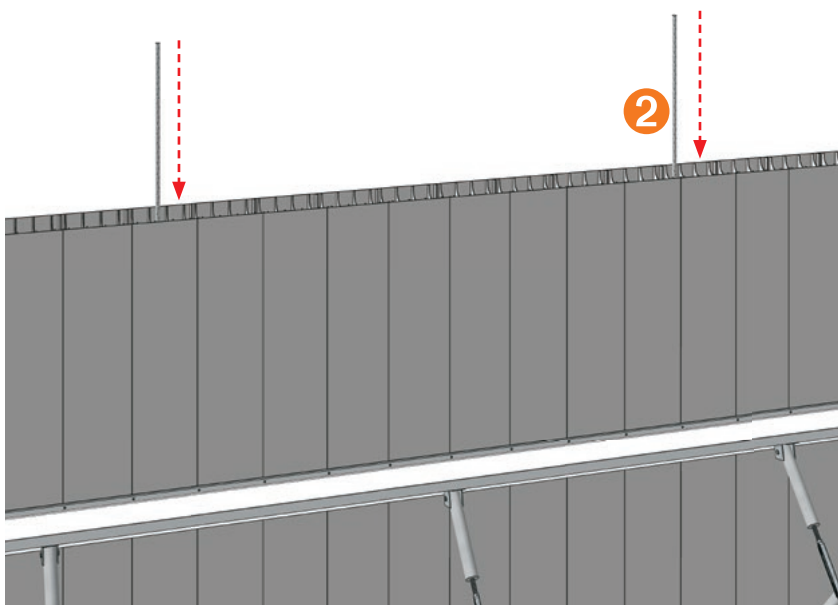

**2** Vertical reinforcement bar should be placed vertically into the rediwall® profile, weaving between alternate horizontal bars. Ensure that the bar will maintain the correct overlap with the previous and subsequent bars where applicable.

Refer to the Project Engineer's specifications for correct overlap and spacing of reinforcing bars.



## Corner Reinforcement Installation With Ezy-fit™ Corner Cap

### Installation of Corner Reinforcing Bars – Single layer

Care is to be taken when installing horizontal reinforcement in corner units as a 'hook bar' and 'dropper' system is recommended.

Reinforcement must be placed in accordance with the project Structural Engineer's specifications

**1** Install two or three rediwall® panels on each side of the corner, then insert the hook bar into the wall and slide it into the corner. Repeat this from the other side of the corner to form a loop in the corner.

**2** Align the 'hook' on each hook bar in the corner and insert the vertical 'dropper bar' from the top of the corner panel and through the loops formed by the mating hook bars.

NOTE: Hook returns should be a minimum of 150mm to prevent the hook twisting in the cavity. (Panel bracing not shown for clarity.)

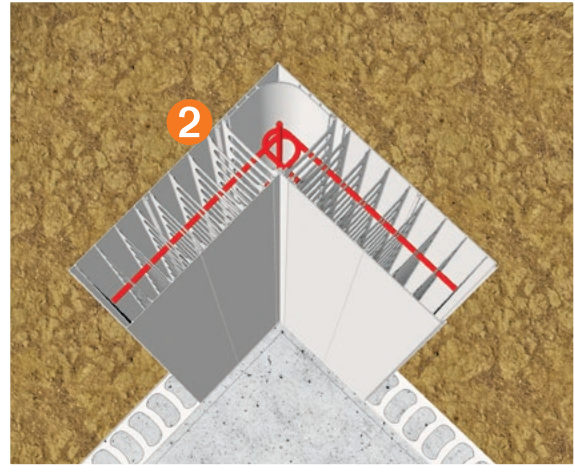
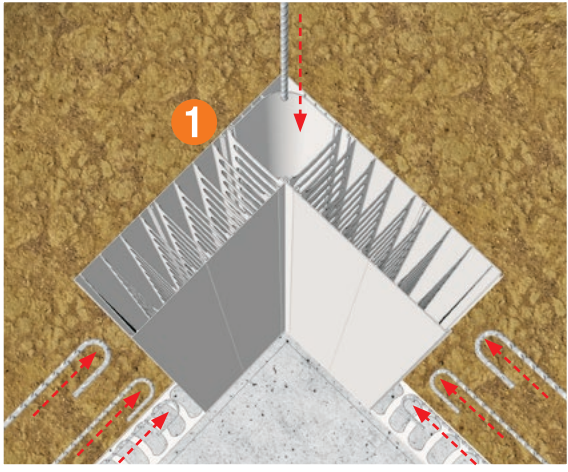
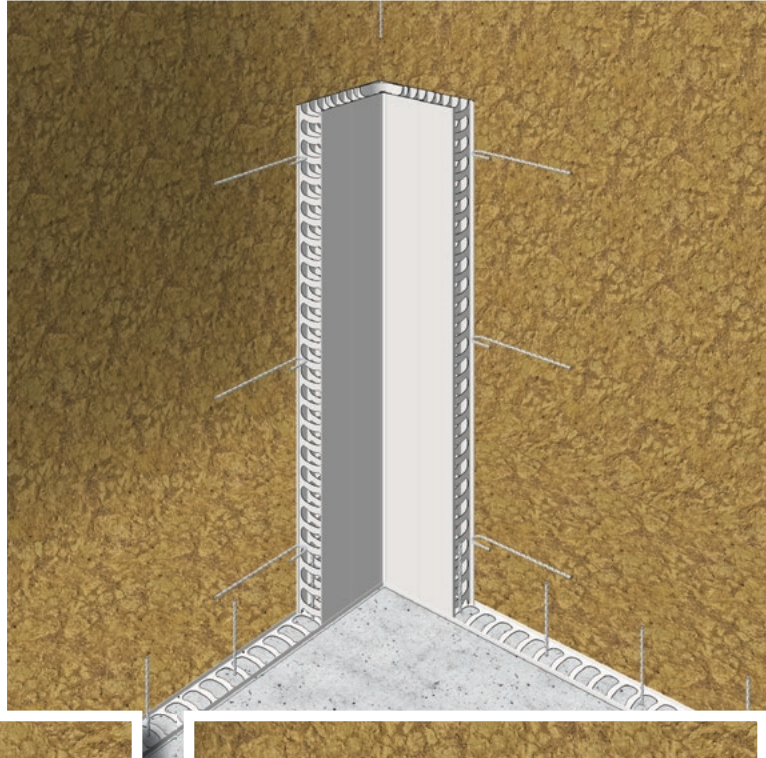

## Corner Reinforcement Installation With Ezy-fit™ Corner Cap

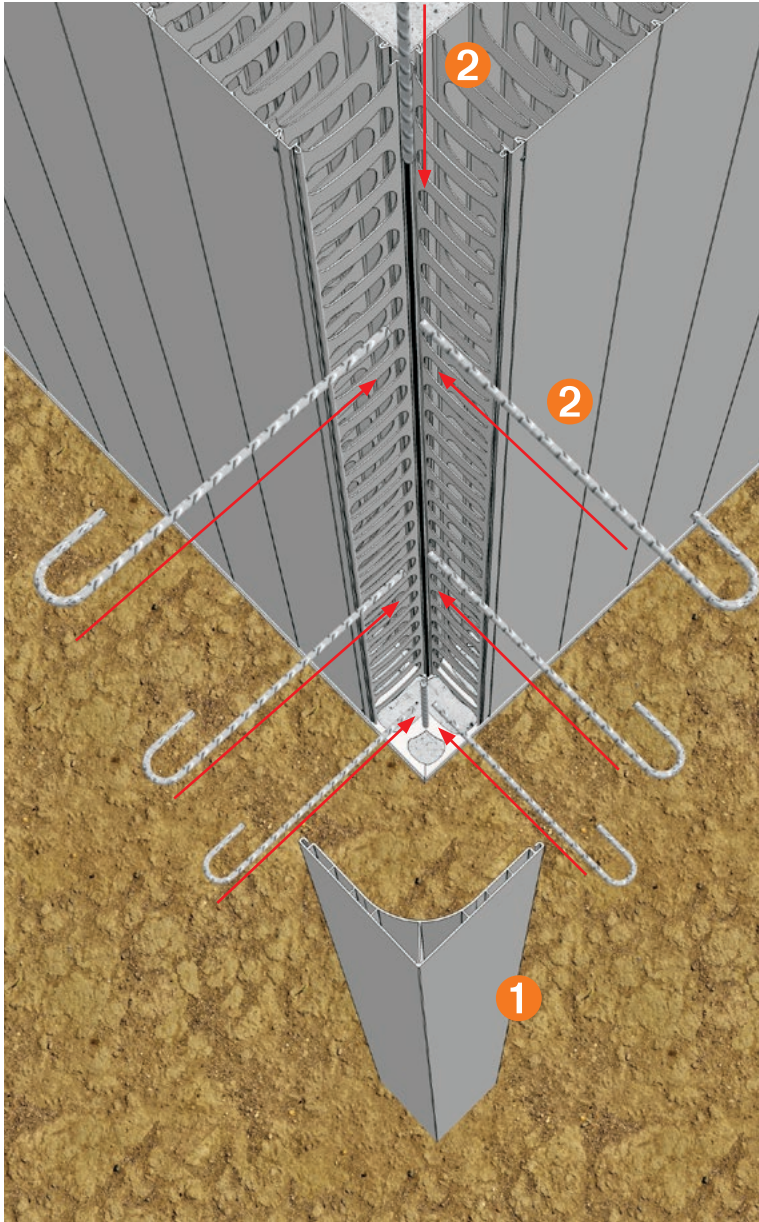

### Installation of Corner Reinforcing Bars – Single Layer (alternate method)

When site access permits, reinforcement bars may be installed from the external wall side.

Reinforcement must be placed in accordance with the project Structural Engineer's specifications.

- 1** Remove the corner cap by sliding up and off the wall.
- 2** Align the 'hook' on each hook bar in the corner and insert the vertical 'dropper bar' from the top of the corner panel and through the loops formed by the hook bars.

Replace the corner cap ready for core filling.

Note: For short wall lengths, horizontal reinforcing can also be installed through the open corner.

## Steel Reinforcement Installation – Double layer

### Installation of R10 guide bar

#### Use of Alignment Bars

R10 alignment bars can be used to assist with location and installation of the vertical reinforcement bars. These alignment bars shall be installed horizontally on both sides of the wall generally at one third the wall height and are installed progressively as the wall is built.

A precut locator can be used to ensure consistent spacing/location of the guide bars.

- 1** Once sufficient number of Rediwall® panels are fixed in place, (for e.g every eight panels). Fix the locator to the Rediwall® inside the web face at the desired locations of the alignment bars.
- 2** Slide an additional panel into place to allow guide bars clearance to overhang the locator clip.
- 3** Slide the alignment bar (R10) through the locator. Guide locators should be placed at approximately 2000mm centres (every eight panel) horizontally.

**Note:** These guide bars are **NOT** to be considered as part of the wall structural reinforcement.

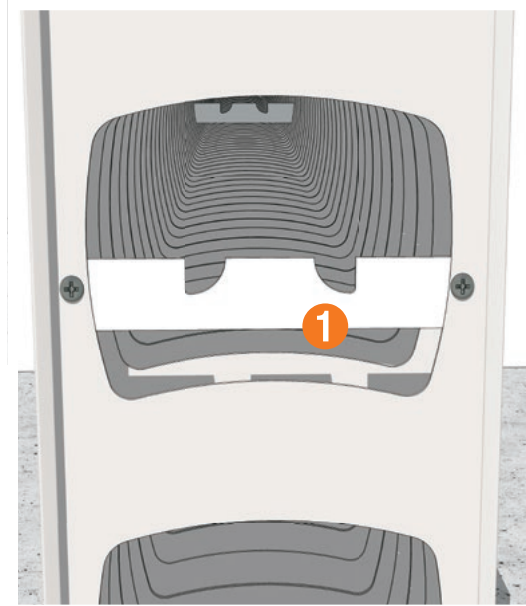
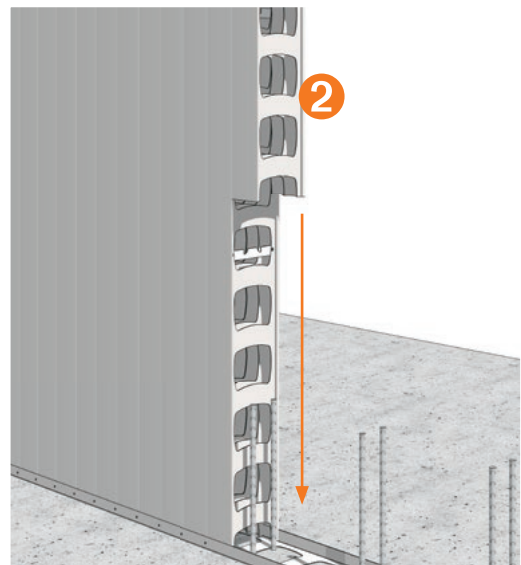
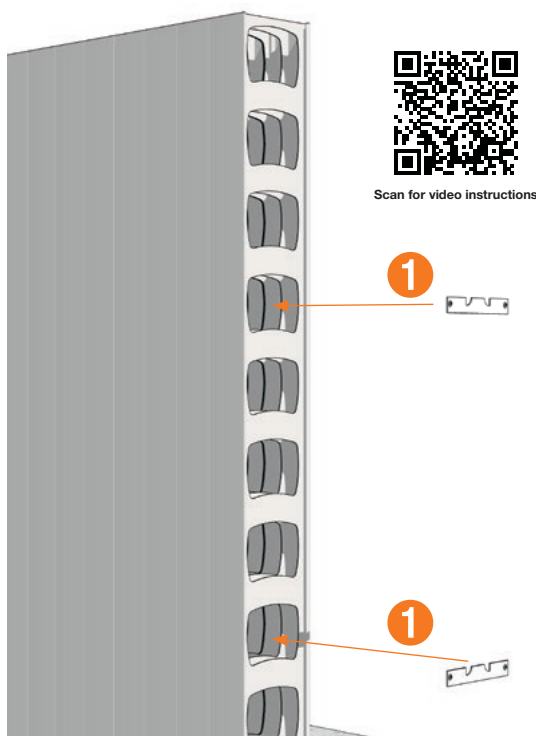

## Steel Reinforcement Installation – Double layer

### Installation of Straight horizontal reinforcing bars – Double Layer

Horizontal reinforcing shall be installed as the panels are erected, in strict accordance a the project engineer's design.

- 4** Once a sufficient number of rediwall® panels are fixed in place, slide the horizontal reinforcement bars through the holes. The shape of the cut hole will help hold the bars in the correct position.

It is important that reinforcement is installed in a uniform manner and the correct spacing is maintained

### Reinforcing placement in short run lengths of wall

In short run lengths of wall, the reinforcement needs to be cut to the appropriate length and, in the case of a blade wall, placed prior to the end of the wall being capped.

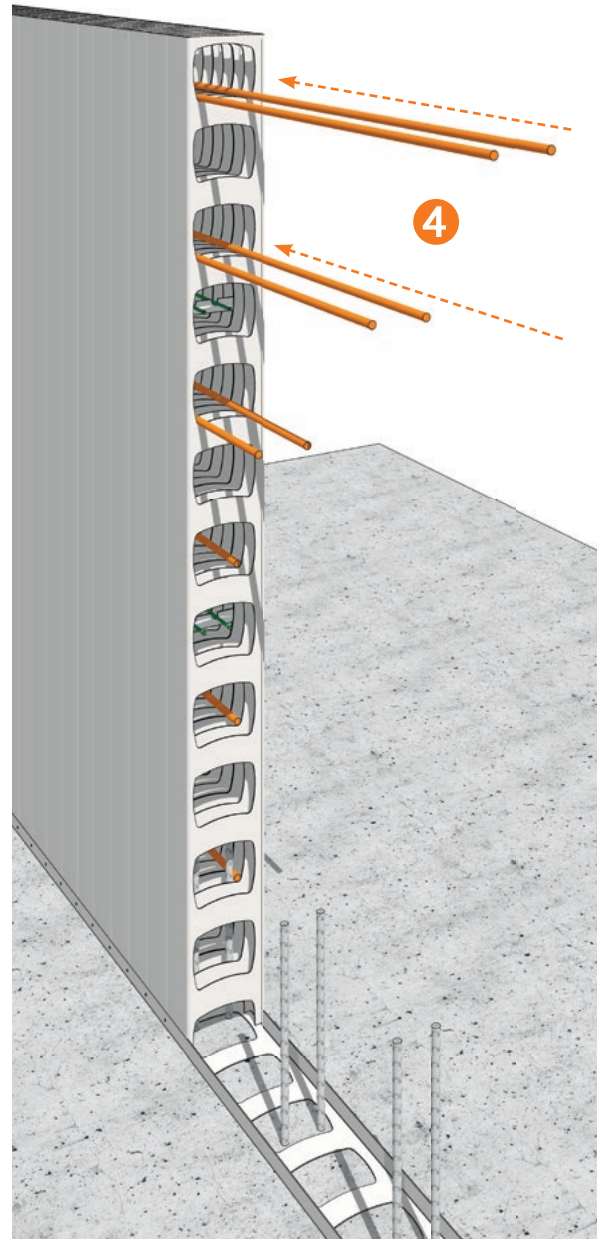

## Steel Reinforcement Installation – Double layer

### Installation of Vertical Reinforcing Bars – Double Layer

If a normal formwork deck is being erected, once the deck is in and it is safe to do so, the vertical reinforcing bars are lifted onto the deck.

- 5** The vertical reinforcement bars are then lowered into the Rediwall® panel, at the correct locations.
- 6** Ensure that the vertical bars are on the internal side horizontal bars, and on the outer side of the alignment bars.

A small 20mm bend at the base of the vertical bar can be used to "joggle" the bar past the horizontal bars.

The offset makes it easy when lowering the vertical reinforcing bars into the wall to weave it in between the locator bars and the outer horizontal reinforcing bars.

A mark on the vertical joggle bars can facilitate locating the alignment bars so that the joggle bars can be paused just above the horizontal locator bar can speed up reinforcement installation.

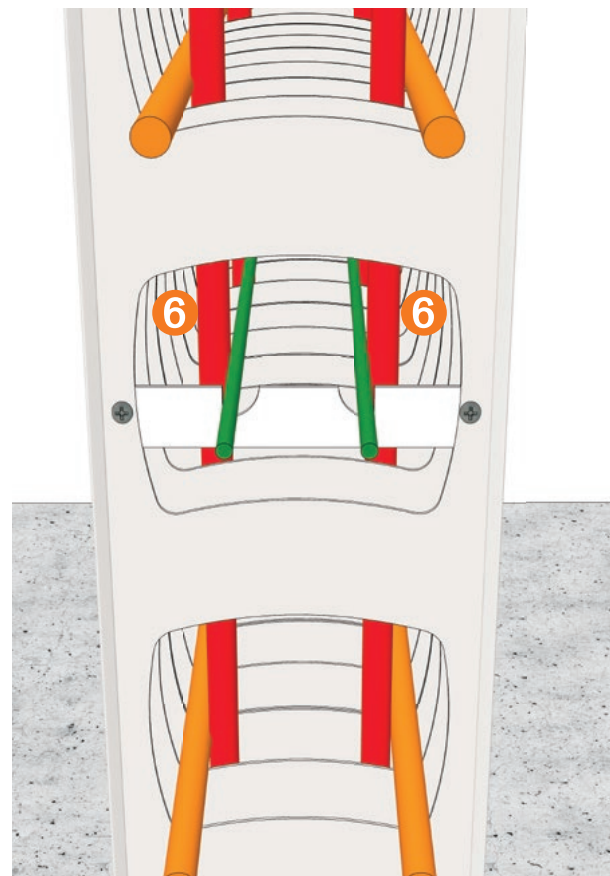
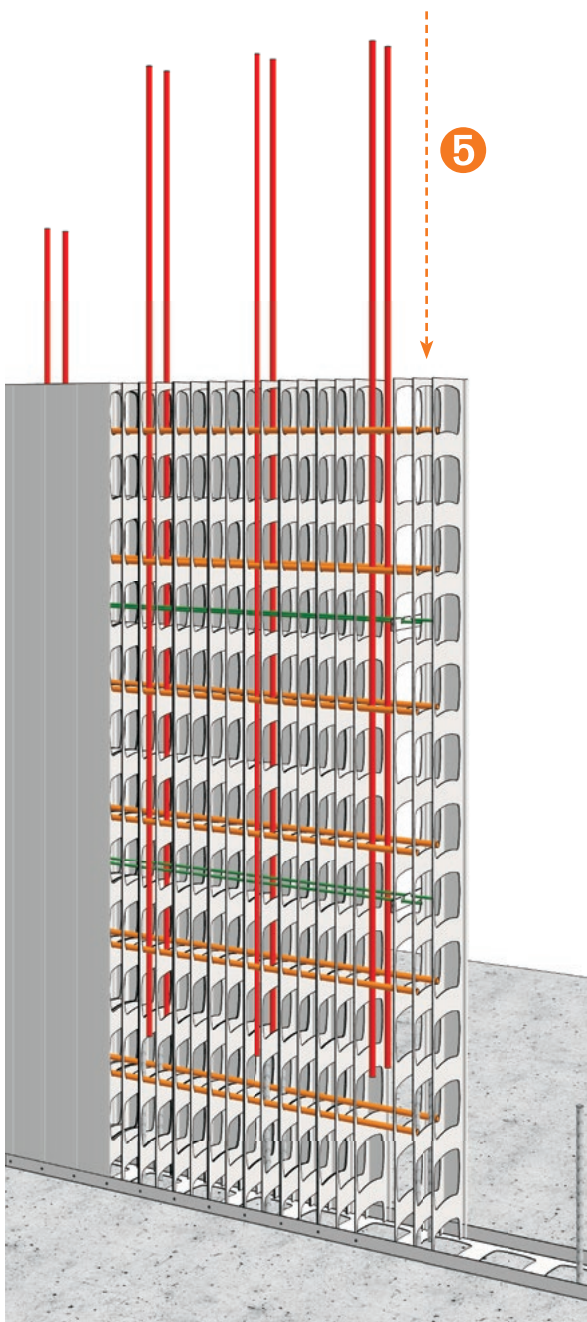

## Steel Reinforcement Installation – Double layer

### U bar Reinforcement Installation

- 1 Install U bars as per the project specification.
- 2 Close off end caps as per details.

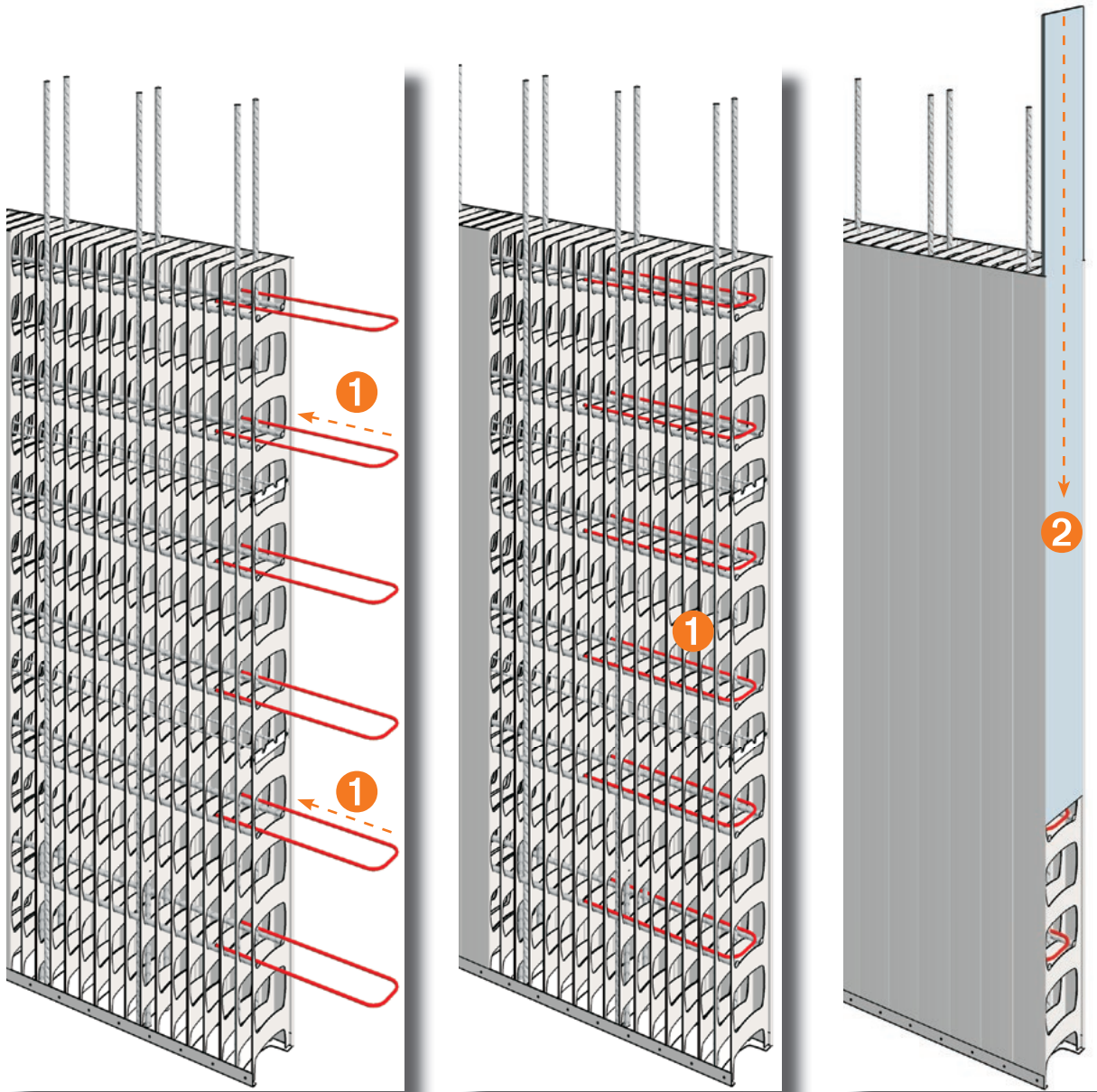

## Steel Reinforcement Installation – Double Layer

### Vertical Reinforcement Tie Off

To positively locate and secure the top of the vertical bars, the following method can be used.

- 1 When the vertical bars have been placed in position, tie the top of each vertical bar to the top horizontal reinforcement as required to ensure bars remain in correct position during concrete pour

Note: Ensure that the bottom of the vertical reinforcement bars are straight and in the correct position

- 2 The top of the vertical bars can also be spaced and locked in correct position by using and LVL timber or similar.

Note: Where the walls are going to continue through on the next level, the vertical bars are left longer by the amount required to clear the slab and act as the starter bar for the wall over. Ensure that the bar will maintain the correct overlap with the previous and subsequent bars where applicable. Refer to the Project Engineer's specifications for correct overlap and spacing of reinforcing bars. On projects where a pre-cast slab system such as Ultra-floor is being used, and it is necessary to pour the afs rediwall® prior to the 'deck' going in, it is necessary to place the vertical reinforcement from either a mobile or temporary scaffold.

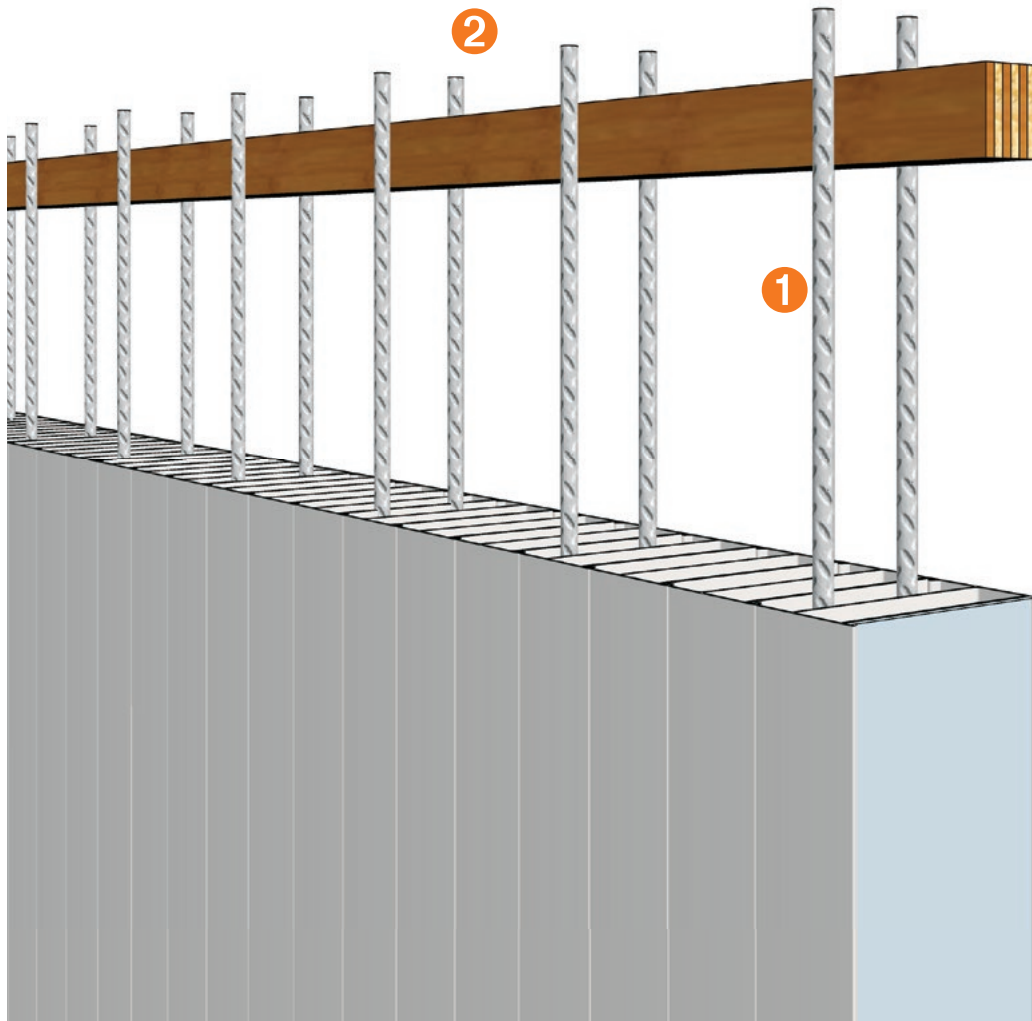

## Base Track installation

### Installation of Horizontal Hooked Bars and Ligatures in Rediwall® Panels

The following procedures outlines the installation of horizontal hooked bars, ligatures in afs rediwall® panels.

**1** Mark the location of the wall and carefully position the floor track over the starter bars and fix it to the floor.

**2** Confirm the location of all starter bars and adjust their vertical alignment so that the required ligature reinforcement can be placed easily over the starter bars.

A steel tube can be used to adjust the alignment of the starter bars where required.

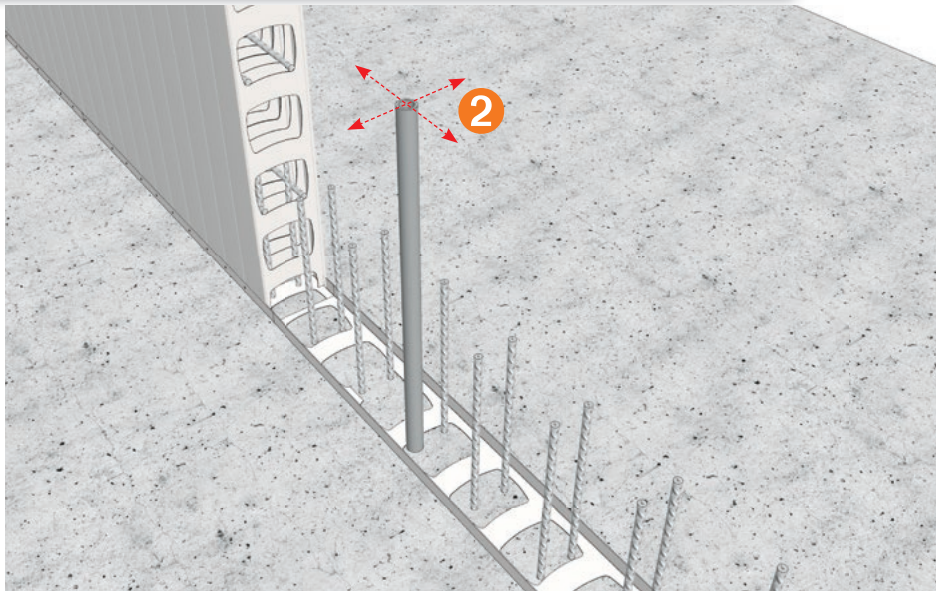
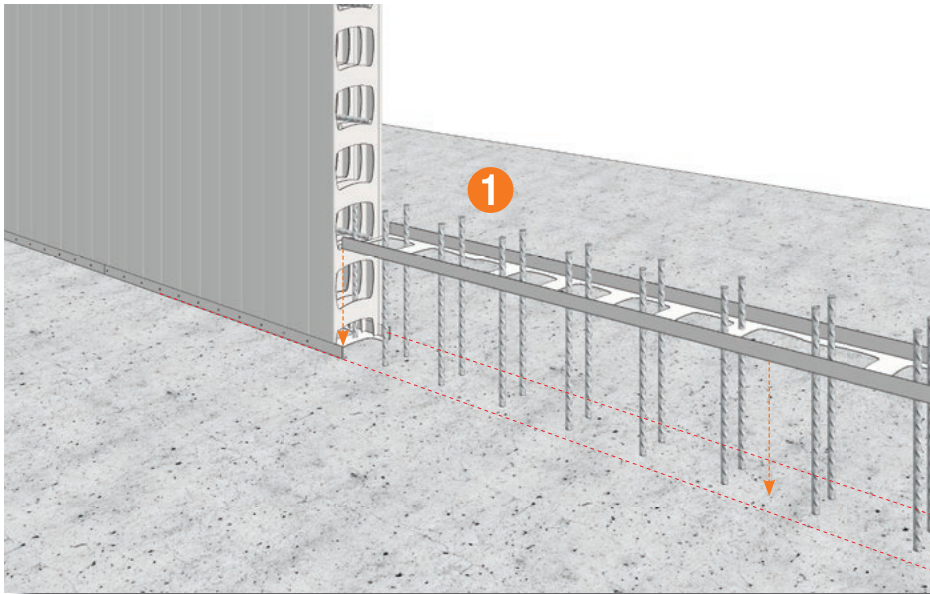



## Steel Reinforcement Installation – Lowest Ligature

Installation of lowest Ligatures over starter bars  
Consult the project engineer drawings regarding the correct location of ligatures.

- 1** Carefully position and lower the ligatures around the starter bars.
- 2** Install the lowest ligatures over the starter bars and place them on the bar chairs. The lowest ligatures should be placed/chaired to a maximum of 50mm above the slab top surface.

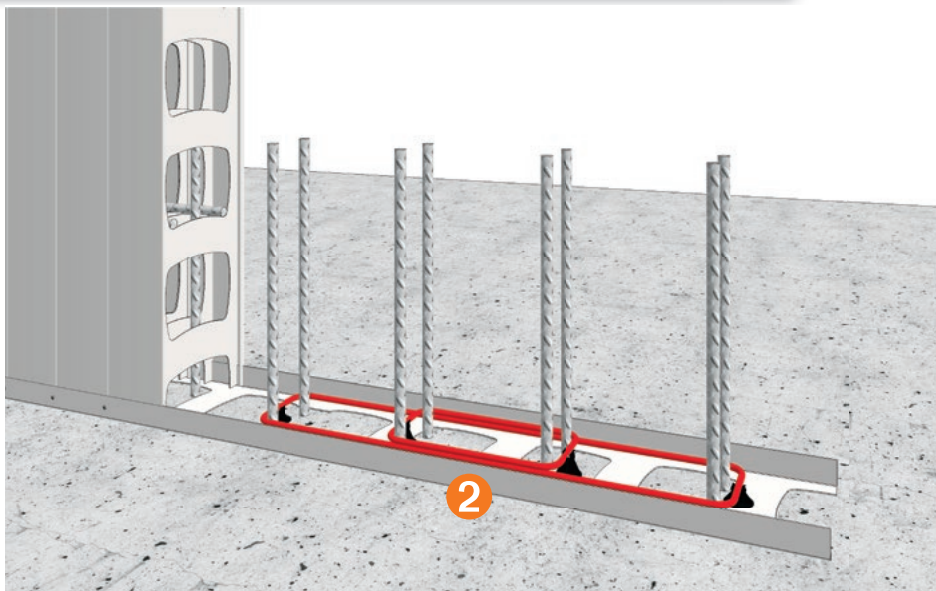
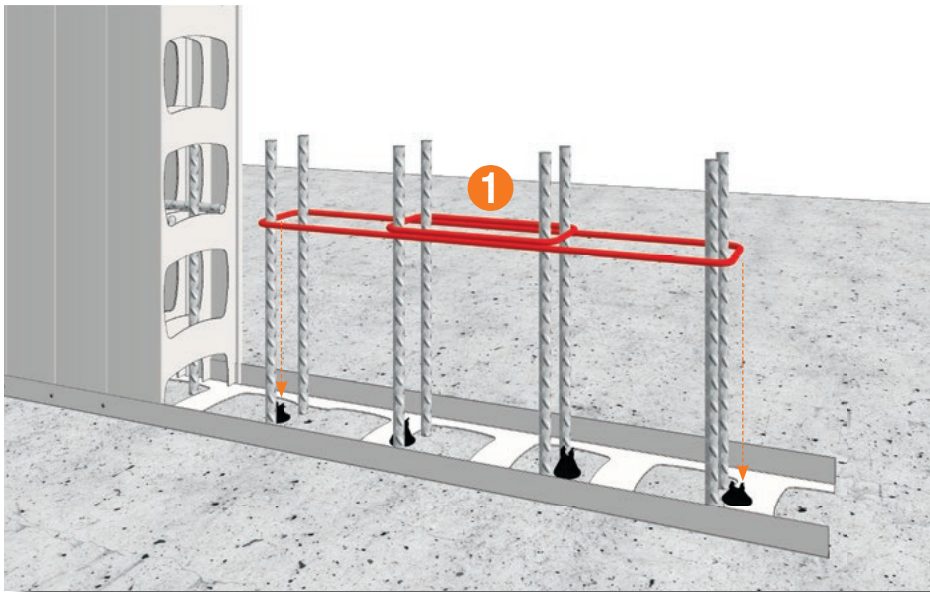

## Steel Reinforcement Installation – Subsequent Ligatures

### Installation of Subsequent Ligatures in the AFS Rediwall® Over Starter Bars

Consult with the project engineers drawings regarding the required locations of the reinforcement ligatures.

Ligatures required over starter bars are to be positioned into the afs rediwall® panels in their correct locations prior to the installation of panels over starter bars.

- 1 Preassemble the rediwall panels (to at least the overall length of the ligature group) fix together with a whaler through the joints of the panels.
- 2 Ensure that the Rediwall® panel assembly suits the ligature sizes. Where required, ligatures can be tied in groups to assist with installation. Slide the ligature assembly into the panel to the correct location.

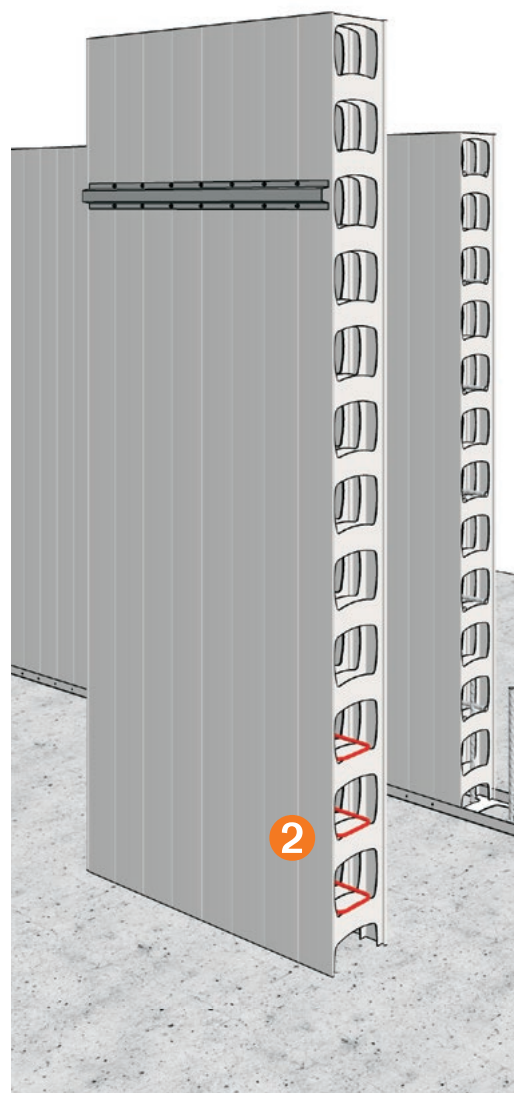
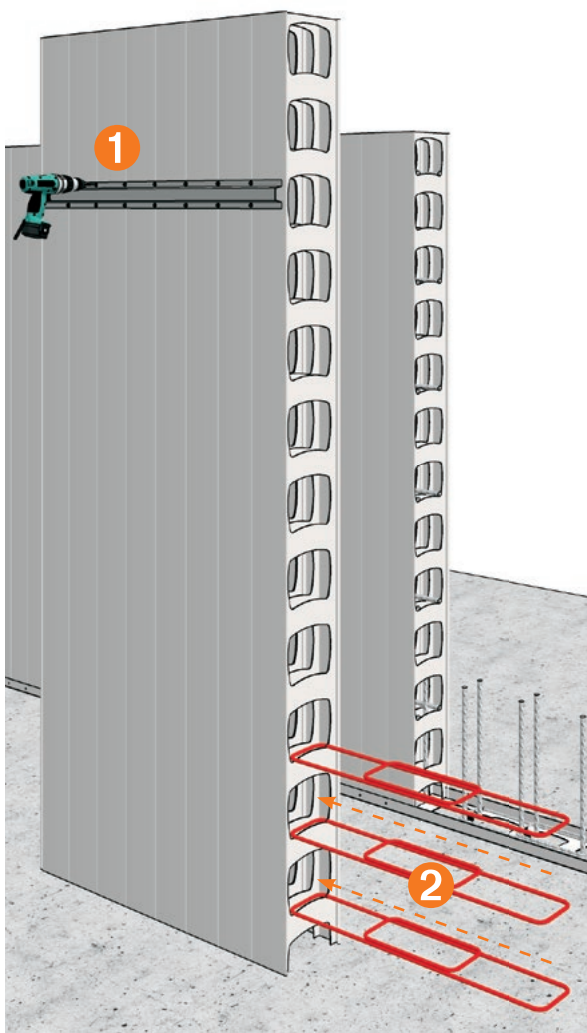

## Steel Reinforcement Installation – Subsequent Ligatures (continued)

- 3** Lift the panel assembly over the starter bars and slowly lower in place. Ensure that ALL starter bars and ligatures engage correctly. (i.e starter bars are located inside the ligatures as per the engineer's details.) AFS approved N16 lifting bars (if lifting via crane) can be used in accordance with the AFS lifting bar procedure (not drawn).
- 4** Check that the pre-installed ligatures inside the panel have not moved out of alignment and adjust if required.

Brace and secure the Rediwall® panels, as per the standard bracing procedure.

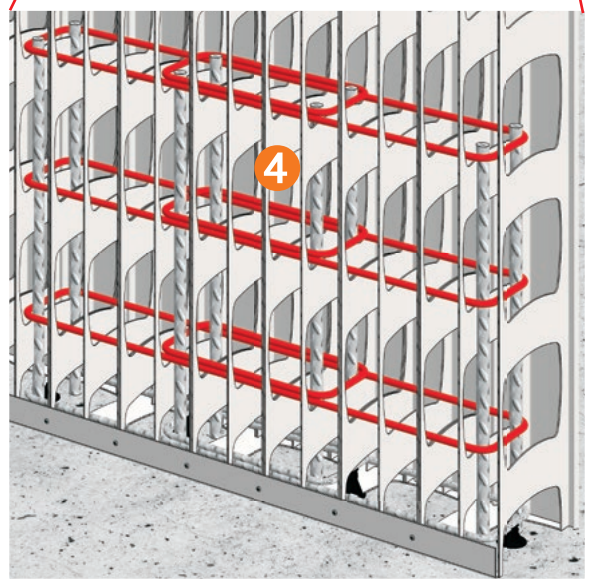
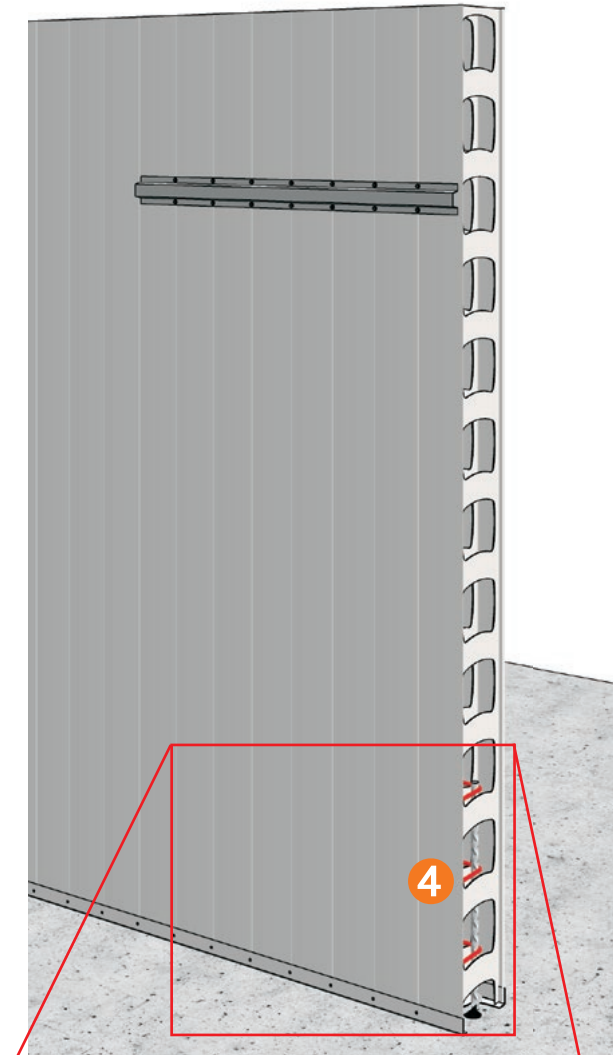
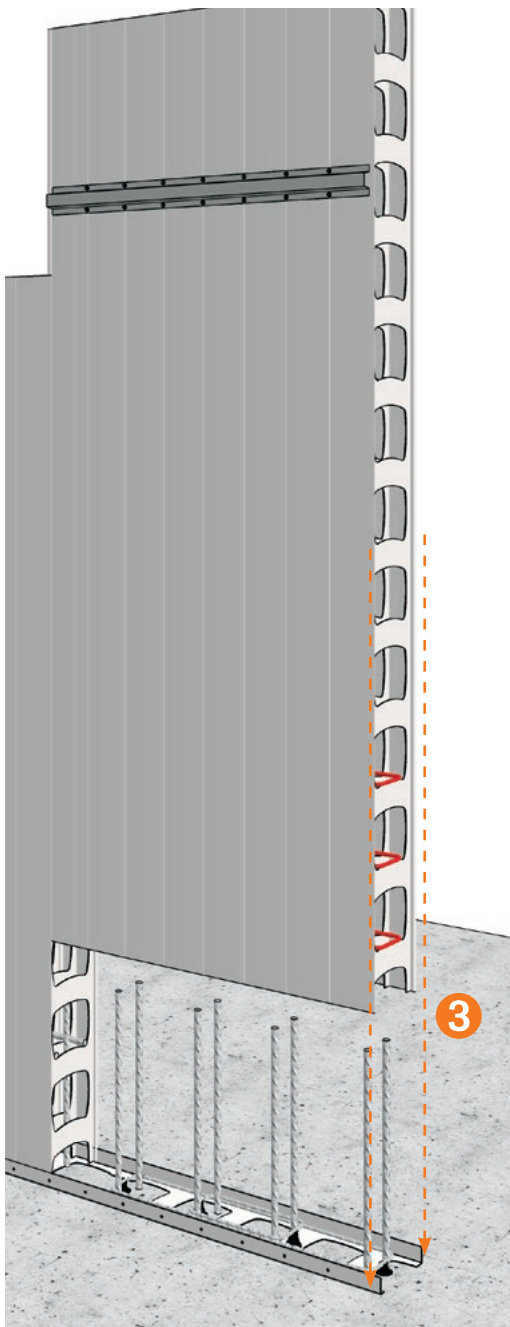

## Installation of Subsequent Ligatures in Panels Above Starter Bars

- 1 Install subsequent ligatures for the remainder of the panel as per the project engineering drawings.
- 2 Ensure that all ligatures are correctly located to allow vertical bars installation.

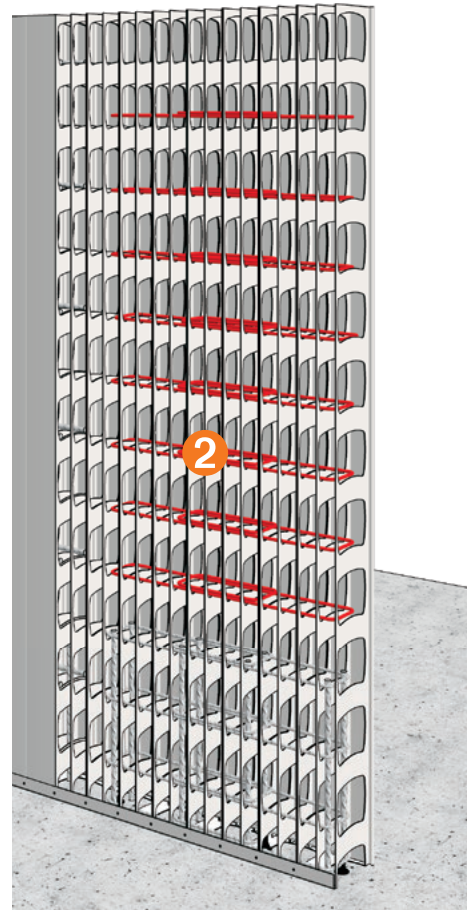
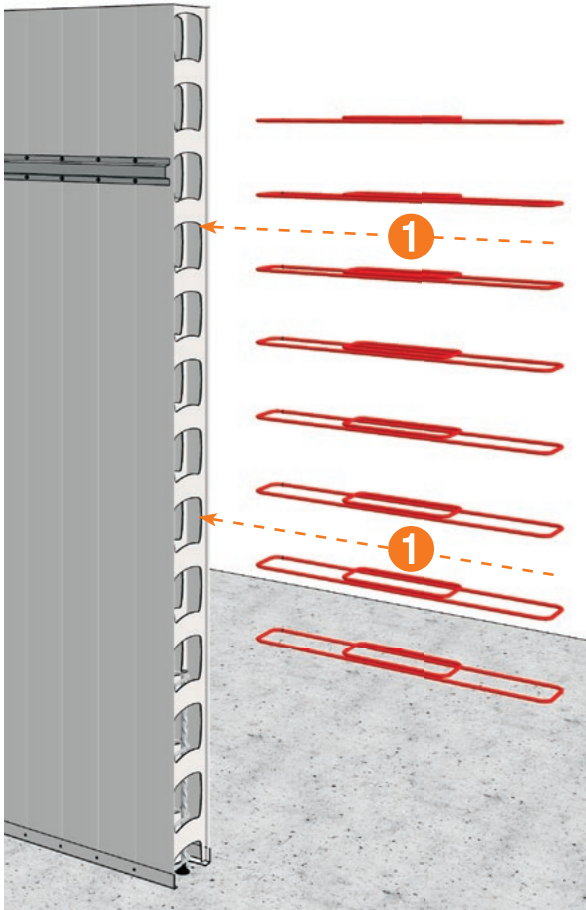

## Steel Reinforcement Installation – Hook Bars

### Installation of Horizontal Reinforcement with Hooks

**1** Slide the horizontal reinforcement bar into the Rediwall® panels ensuring that the hook bar face is in a vertical position and is placed on the outside of all the starter bars.

**2** When the horizontal bars are slid in their correct final location, rotate the hook so that the hook rests horizontally on the webs.

Repeat for both sides of the wall, turning the hook inwards and resting on the webs.

Install horizontal hook bars progressively above the starter bars as the wall is built. Note that horizontal hook bars shall be lapped as per the project engineer's details.

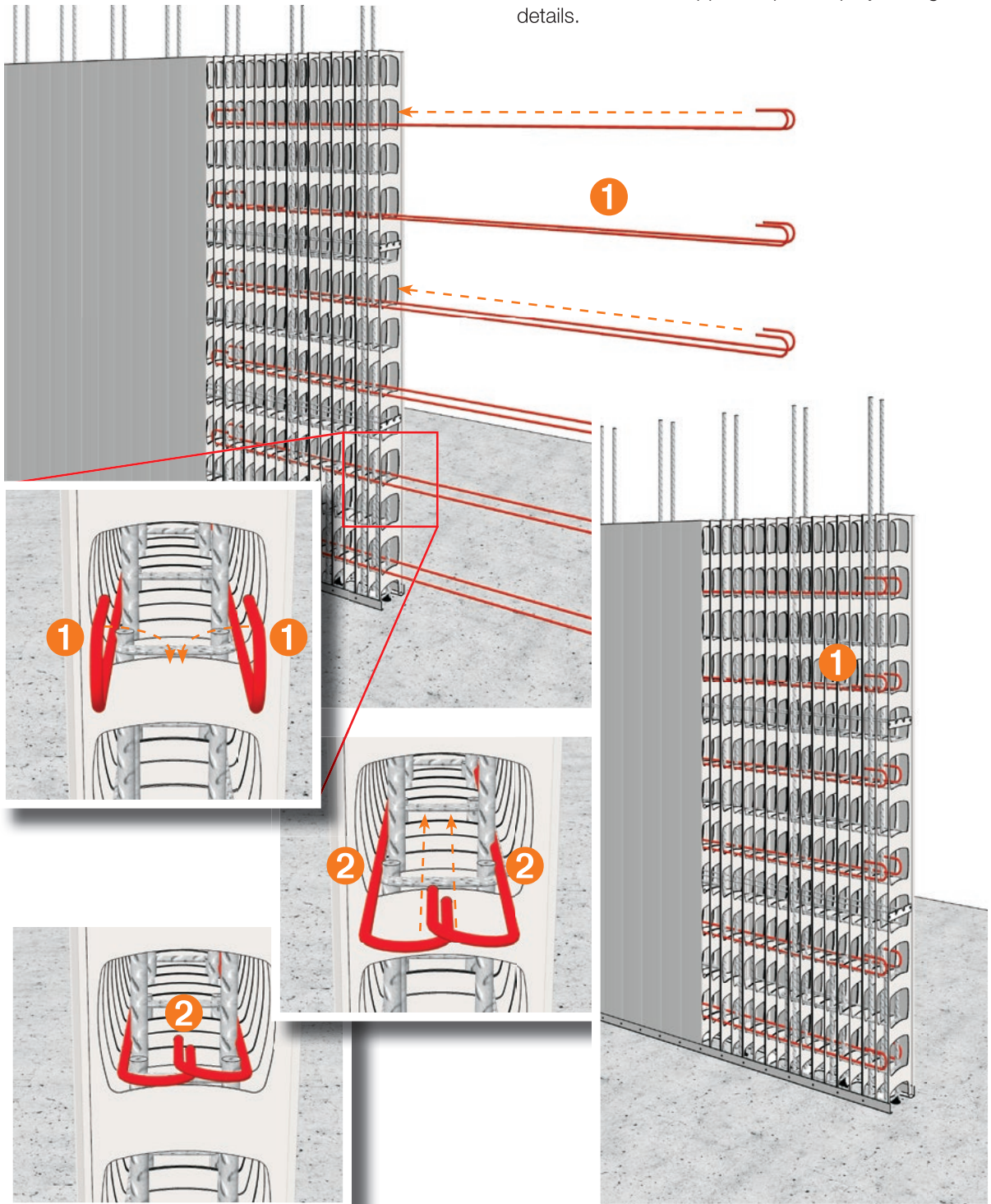

## Corner Installation – RW200C, Hooked U-Bars or Closed Ligatures

### Site Assembled Corner Panels

**1** Preassemble ligature/ hook bar reinforcement configuration and tie together (where required). Check reinforcement assembly against starter bar placement to ensure that the starter bars will fit in. Fix floor track and install the first layer of ligature/hookbar. The lowest ligatures should be placed/chaired to a maximum of 50mm above the slab top surface (where required).

**2** Assemble the corner with enough wall panels on each side so that it can fully accept the ligatures. Screw fix corner the corner brace (400mm x 400mm) to the inside of the corner assembly (top, middle and bottom of panels) this will secure the assembly. The corner cap may be fixed in an open position so that there is access to the lower ligatures.

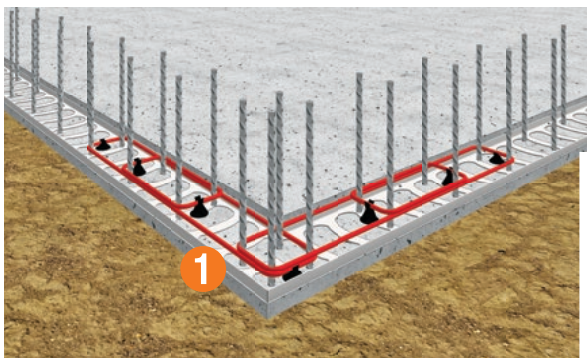
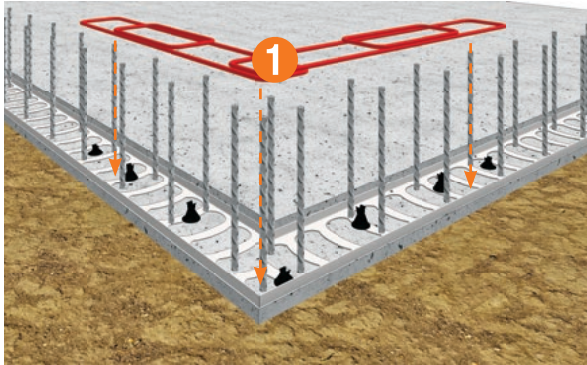

**3** Install the ligatures up to the level of the starter bars into the corner assembly. Locating as close as possible to their final position.

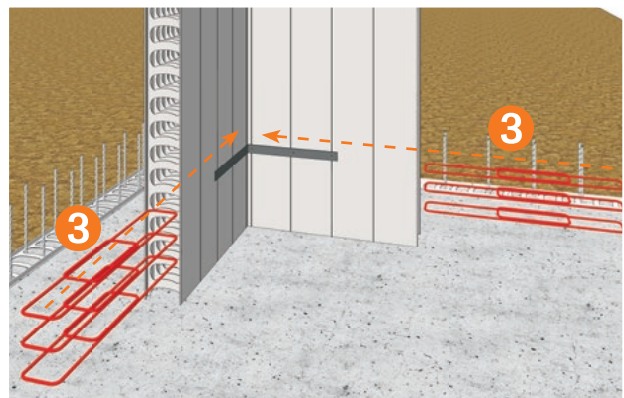
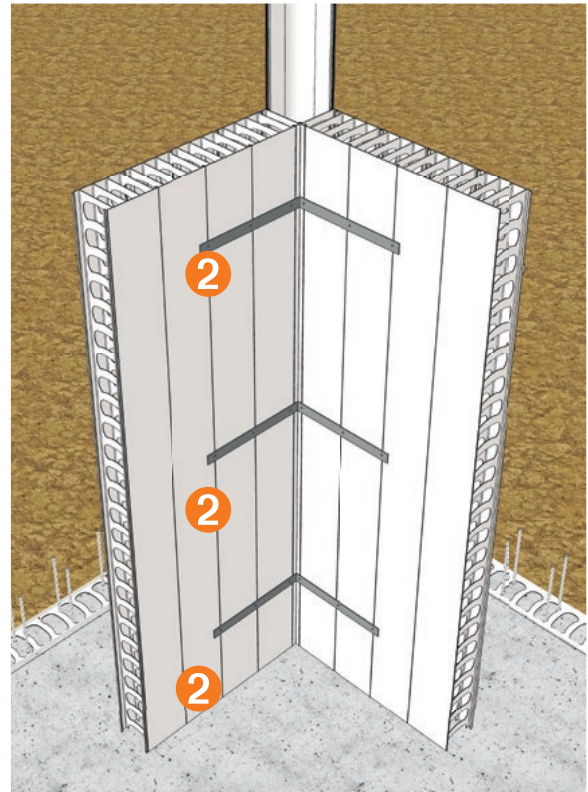

## Corner Installation –RW200C, Hooked U-Bars or Closed Ligatures

- 4 Insert two AFS approved N16 lifting bars (if lifting via crane) in accordance with AFS lifting bar procedure, with suitable lifting straps into the tops of the panels. Ensure the corner cap is installed so that access to the lower ligatures is maintained.
- 5 Fix a top hat whaler to either side of the outside face of the corner assembly and maintain the position of the corner cap (if needed).
- 6 With two people lift the corner assembly or using a crane, lift the corner assembly over the starter bars and slide the assembly into place, with a person adjusting the ligatures and starter bars as required as the assembly is lowered into position.

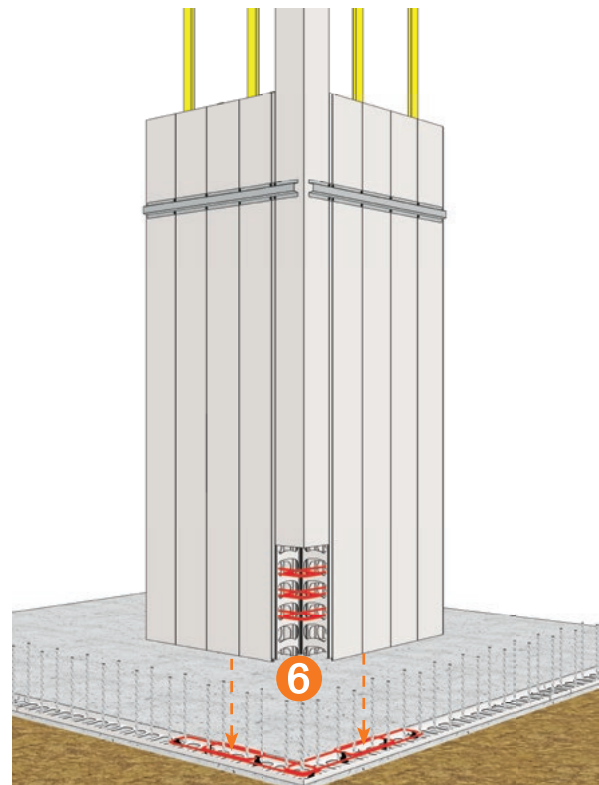
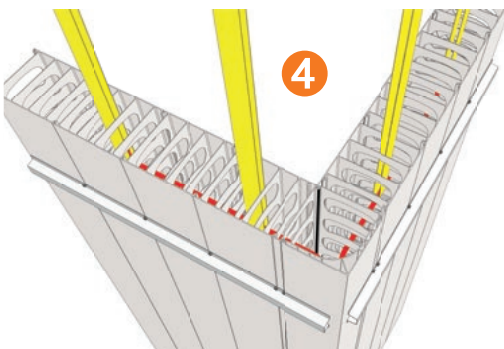
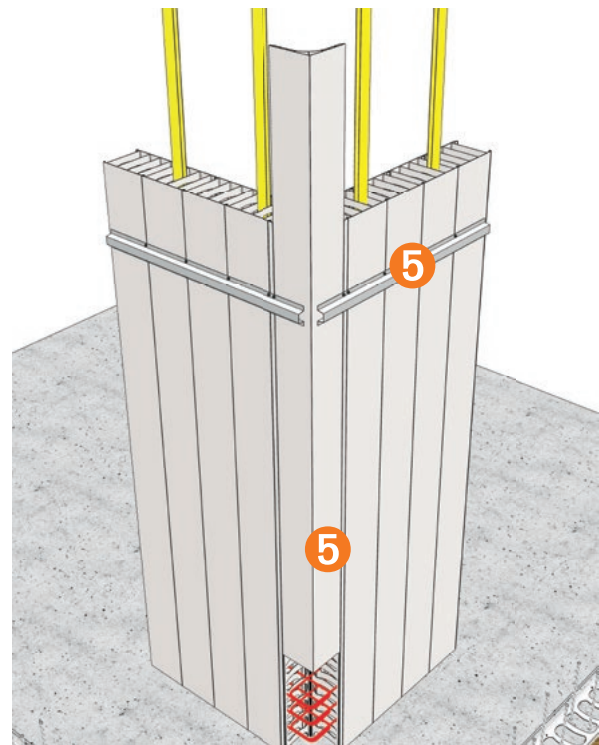
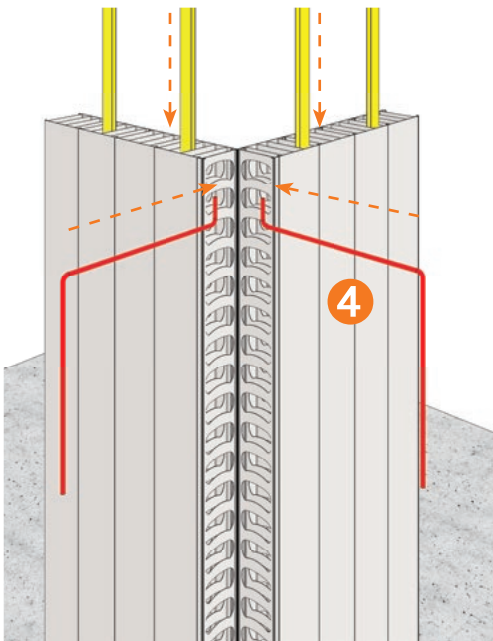

## Corner Installation –RW200C, Hooked U-Bars or Closed Ligatures

- 7** Slide the corner cap up and install remaining U-bar/preassembled ligature reinforcement into the corner above the starter bar level.
- 8** Install the vertical reinforcement and replace the corner cap. Plumb, square and brace the corner as per the standard bracing procedure. Remove corner braces.

Note: If tying of the vertical bars to the starter bars is required, insert the vertical bars before any Horizontal reinforcement is installed and lift the panels enough to allow access for tying.

If craning the corner assembly into place all ligatures may be installed prior to lifting.

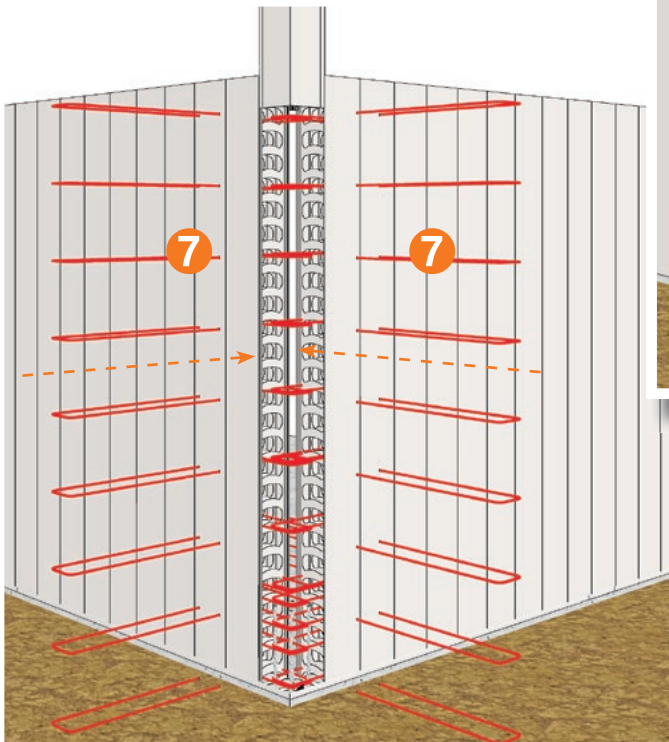
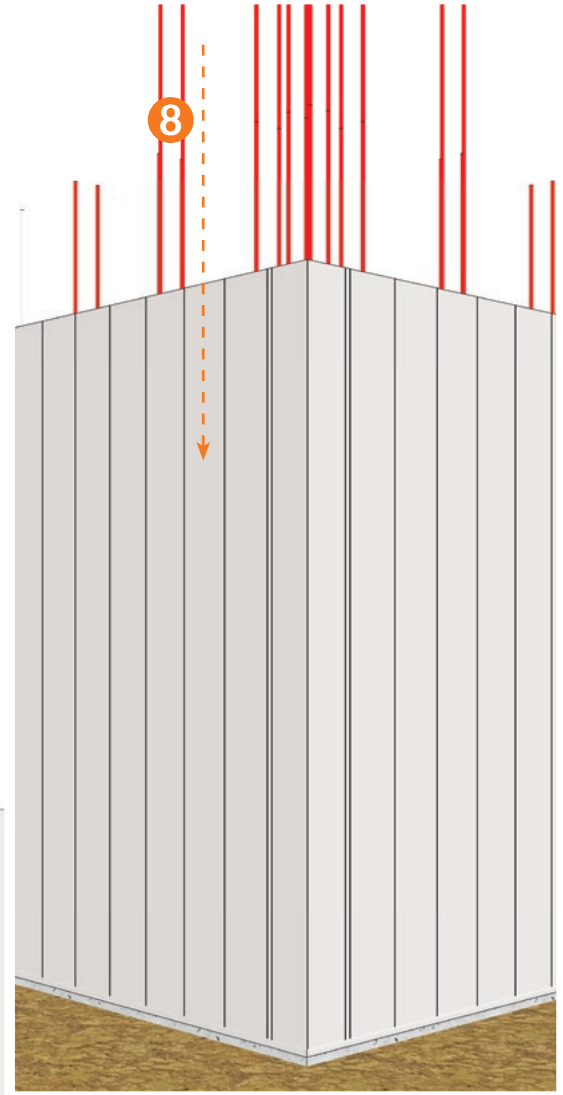
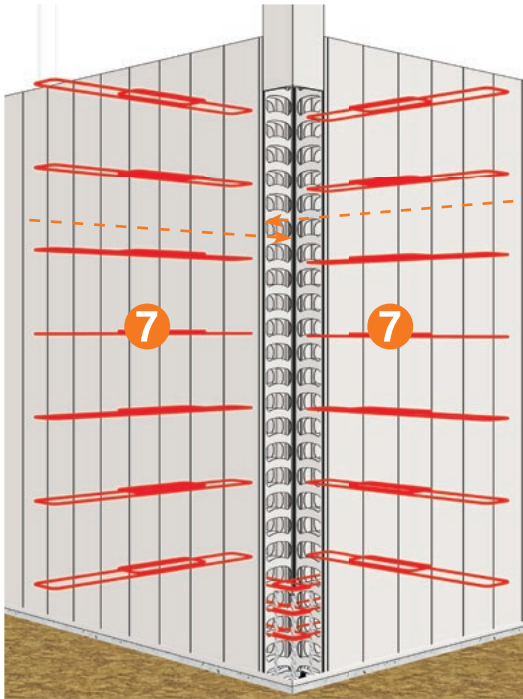



## Corner Installation – RW256S, RW275S, RW300S – Open Corner

### Site Assembled Corner Panels

**1** Fix floor angle (50x50mm) for RW275S or RW300S (or floor track for RW256S). Preassemble ligature/hook bar reinforcement configuration and tie together (where required). Check reinforcement assembly against starter bar placement to ensure that the starter bars will fit in. Install the first layer of ligature/hookbar. The lowest ligatures should be placed/chaired to a maximum of 50mm above the slab top surface (if required).

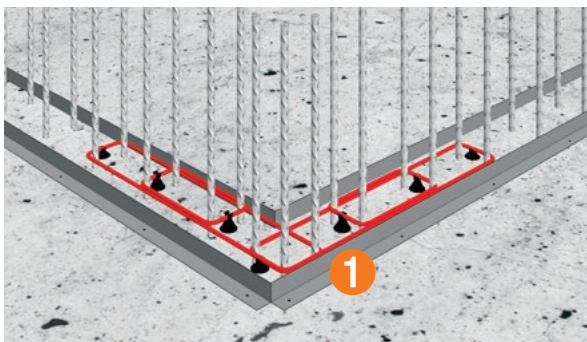
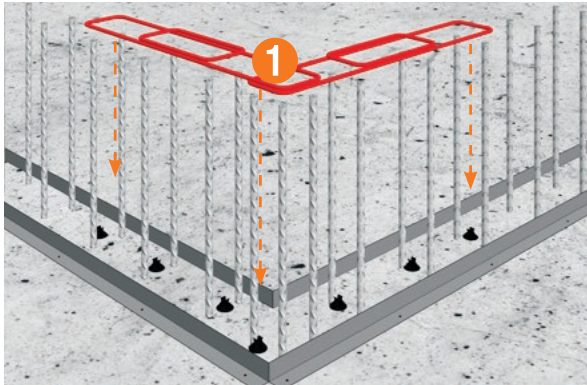

**2** Assemble the corner with 2-3 panels (or enough to fully accept the ligatures) for each leg of the corner and screw fix together at the joints. Install internal corner angle (standard 30x30mm angle) to one of the corner lags - fixing to the male end of the panel using tek-screws (type-17 metal) Panels should be ideally be laid down.

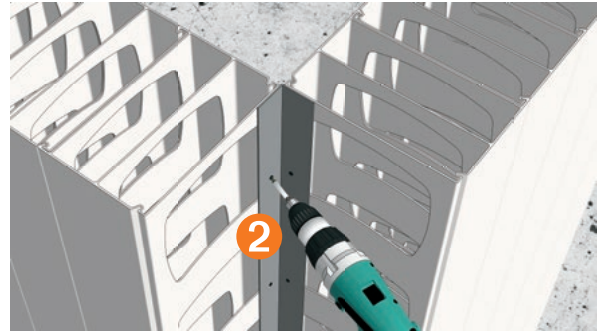

**3** Install the three corner angle brackets at the top, middle and bottom of the panels avoiding the location where final wall bracing will be fixed to the walls.

**4** Insert the preassembled ligatures to the height of the starter bars or full height of the panel locating as close as possible to their final position.

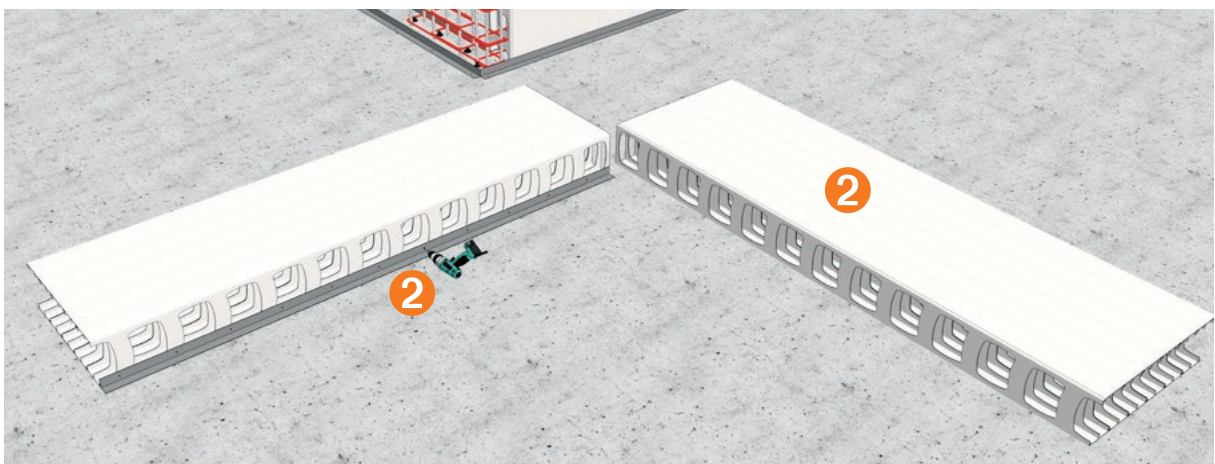
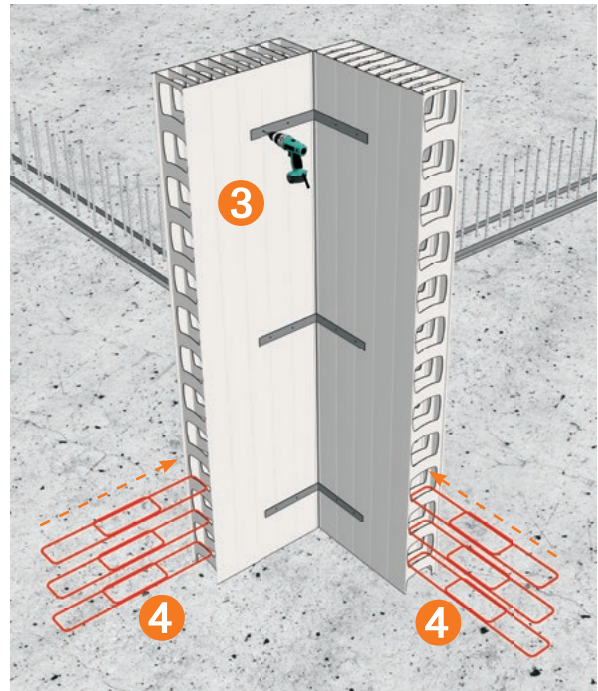

## Corner Installation – RW256S, RW275S, RW300S – Open Corner

- 5** Insert the AFS approved N16 lifting bars into each leg of the corner (total of 2 lifting bars) in accordance with AFS N16 lifting bar details/drawings with appropriate lifting straps and attached to crane (in accordance with on-site crane requirements) for the lift.
- 6** Lift the corner assembly over the starter bars and slide the assembly into place, adjustment of the ligatures and starter bars may be required as the assembly is lowered into position.

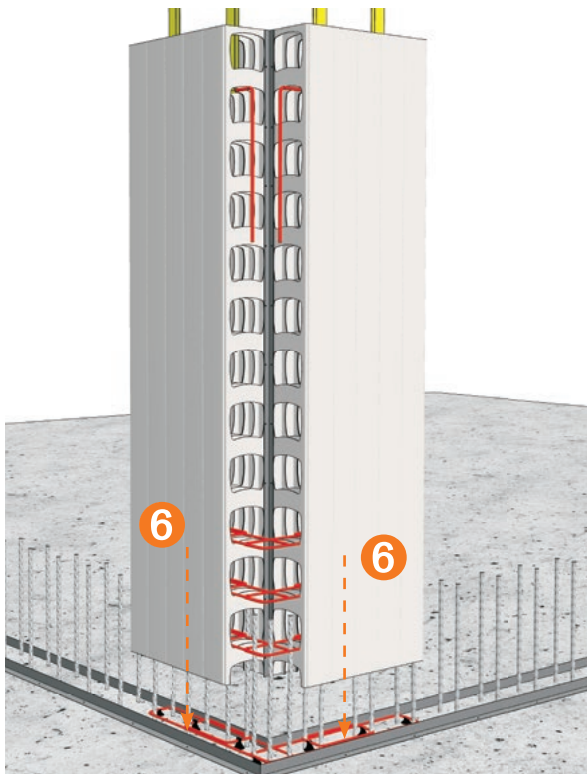
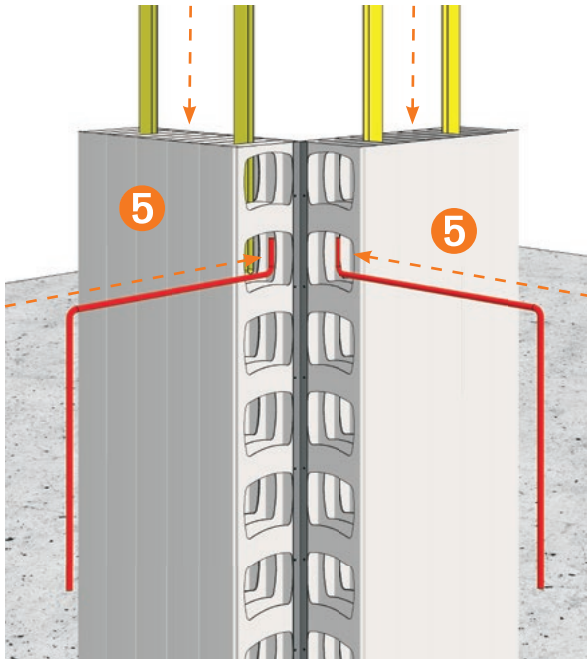

- 7** Install remaining ligatures as required into the corner assembly if not previously installed.

If tying vertical bars to the starter bars is required, install vertical reinforcement, lift the corner panel assembly up to allow access to the bottom of the vertical bars and starter bars, once tied lower the assembly back into place.

Plumb, square and brace the corner assembly. Refer to the AFS standard bracing section for details. Screw fix the panels to the floor angles (or track for RW256S) and remove the corner brace.

- 8** Once all reinforcement is installed screw fix the corner shutter (90° metal squint or form ply – supplied by others) to the outside of the corner assembly and brace.

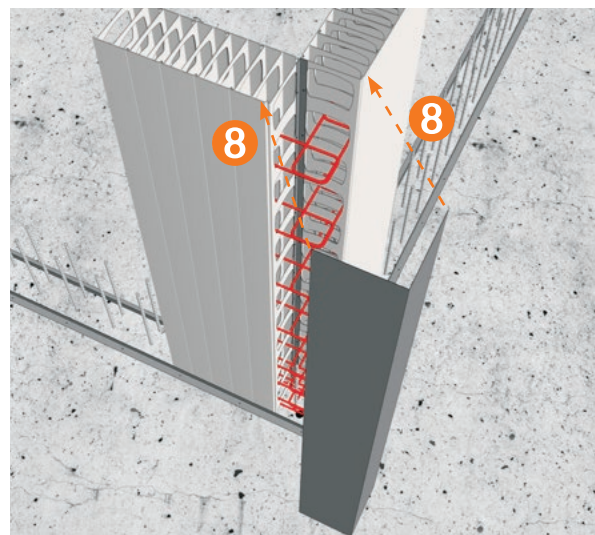
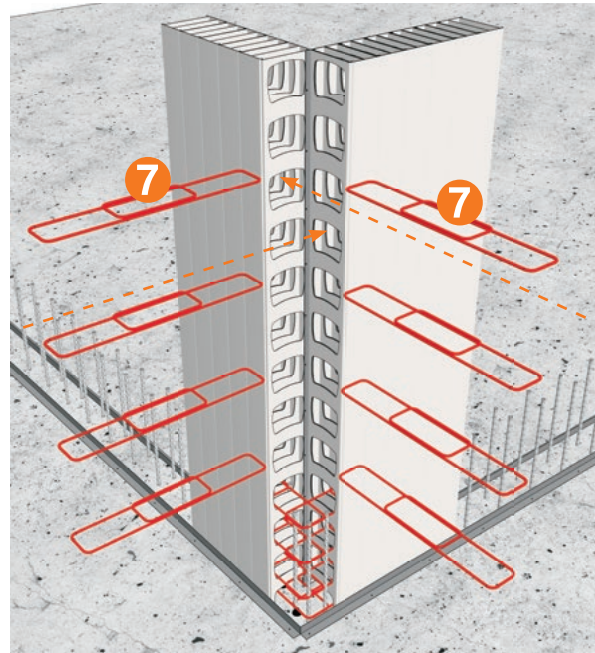

## Wall Construction

### Full Height Panels

- 1** Install additional rediwall® panels by clipping each panel into the previous one and sliding it down into the floor track. This procedure is repeated to form a complete wall.
- 2** Plumb the wall section vertically, install bracing and fix each panel to the floor track as construction proceeds.
- 3** Wall sections are formed using full rediwall® panels. If a space of less than 250mm is left, spacers and H Joiners installed vertically can be used to make up the required distance. H Joiners can be used vertically for a gap of 50mm (38mm for RW200) or less, screw fixed both sides at 150 centres to adjoining panels. Spacers are available in some systems, refer to the components page for availability.

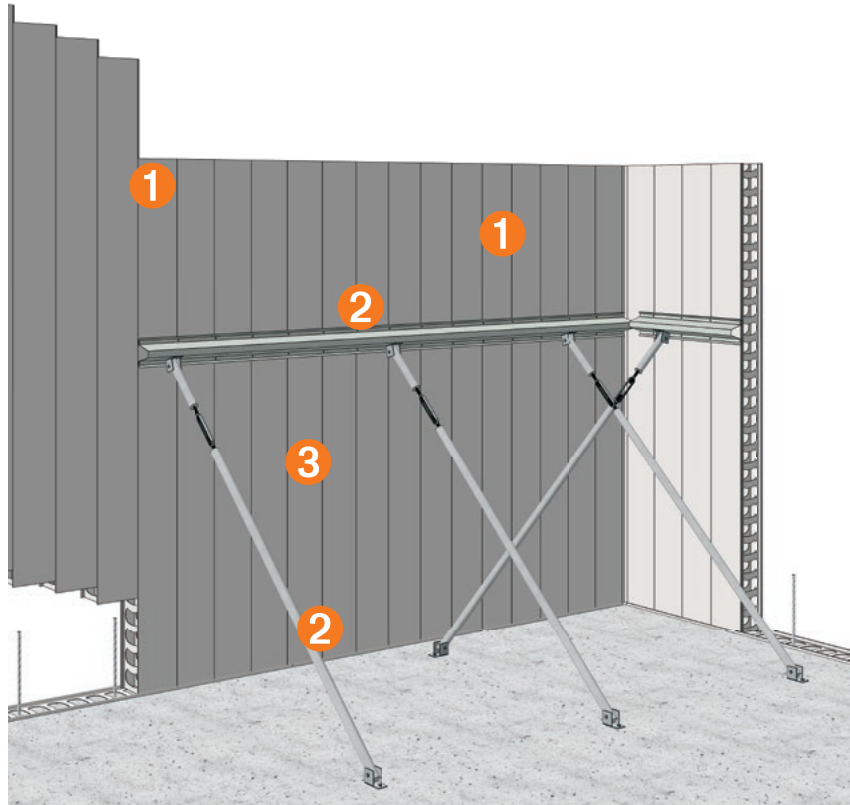

#### WARNING

Refer to the Bracing section for detailed requirements and methodology.

## Safety Rail/Balustrade Wall Installation

### Balustrade Wall

**WARNING:** Where rediwall® panels are to continue past a slab to form a balustrade, care shall to be taken when creating openings in the rediwall® panel face to ensure that the webs inside are not damaged causing the panels to be weakened.

- 1** Install the rediwall® panels as per the standard method.
- 2** Engagement of the wall and slab can be achieved by cutting holes in the rediwall® face to install reinforcing bars. Use a hole

saw as per Structural Engineer's details (100mm maximum diameter).

- 3** Insert the required reinforcement steel as per the Structural Engineer's details. When filling these safety rail/balustrade walls, fill initially to the bottom of slab level. Filling upper section shall be completed after the slab has been poured.

**IMPORTANT:** When being used as Safety Rail it is up to the Project Engineer to determine the required

specifications and ensure that all mandatory requirements are met.

**Note:** Care should be taken when core filling that no concrete loss occurs due to the opening of the panel face as this may create voids in the wall.

Extra bracing may be required to ensure panel stability during slab pour.

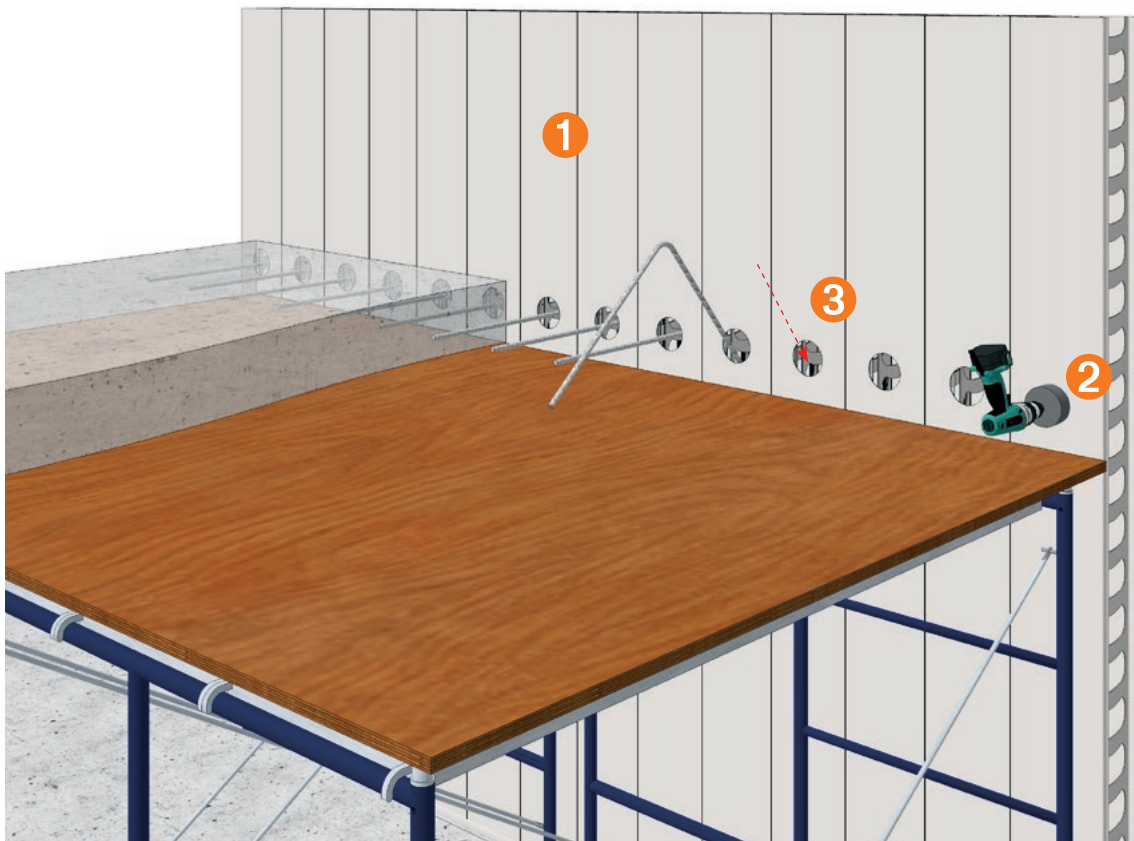

## T-Junction Construction

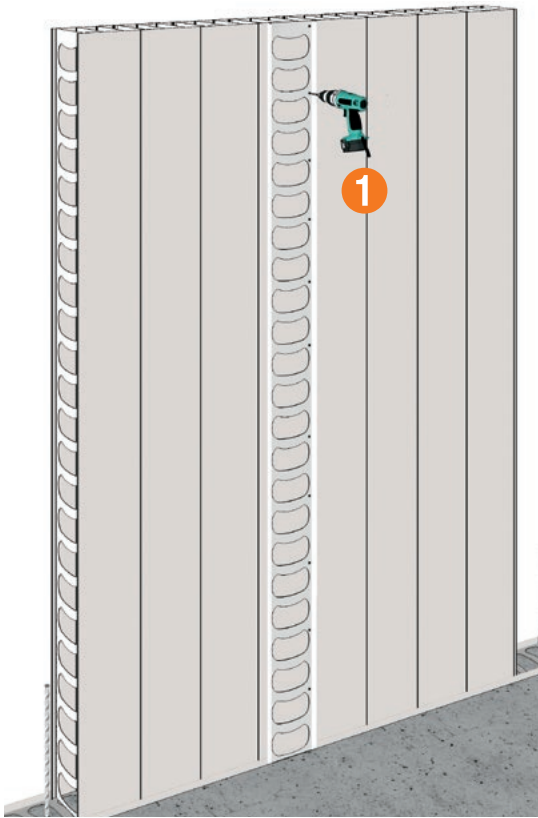

NOTE: Where a T-junction is to be formed, T-Joiner Track is to be used for vertical alignment. T-Joiner Track is used when core fill flow-through and reinforcement tie-in are required. If joining a male panel end at junction, use floor track in lieu of T-junction.

- 1 Place the T-Joiner Track vertically up the wall and fix the T-Joiner Track to the existing rediwall® panels with screws each side at 150mm vertical centres.

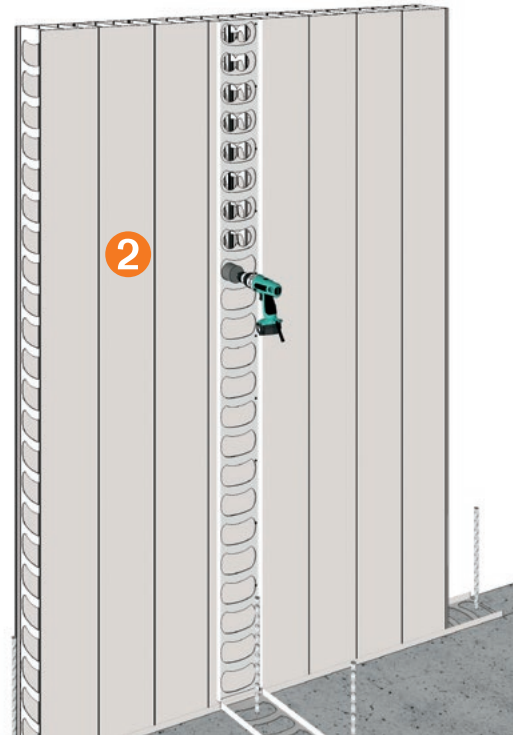

- 2 Use a hole saw to cut the rediwall® panels to allow for concrete core fill flow and steel reinforcement installation where appropriate. Refer to the Project Engineer's specifications.

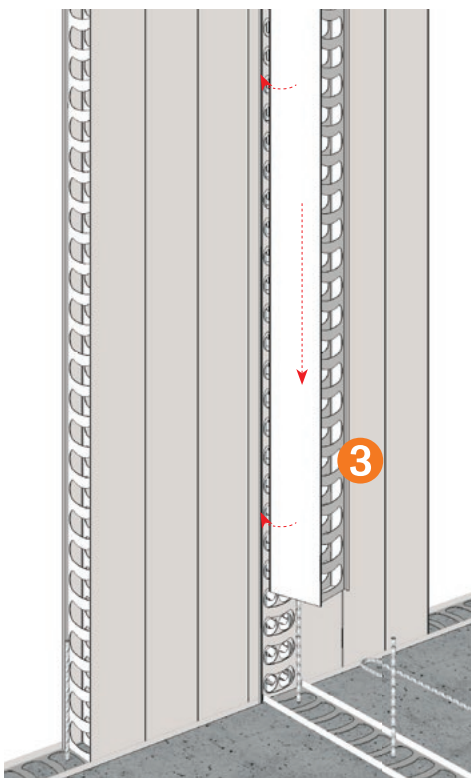

- 3 Install the first rediwall® panel to the vertical T-Joiner Track and ensure the clip edges lock securely each side of the wall.

- 4 Once a suitable number of panels have been installed, slide the hook bars through the tee wall and into the primary wall, as per engineer's details.

- 5 Ensure hook bars are aligned and slide a vertical dropper bar into the primary wall and through the hooked bars.

Bracing for T-junctions not shown for clarity. Refer to the Bracing section in this guide for details.

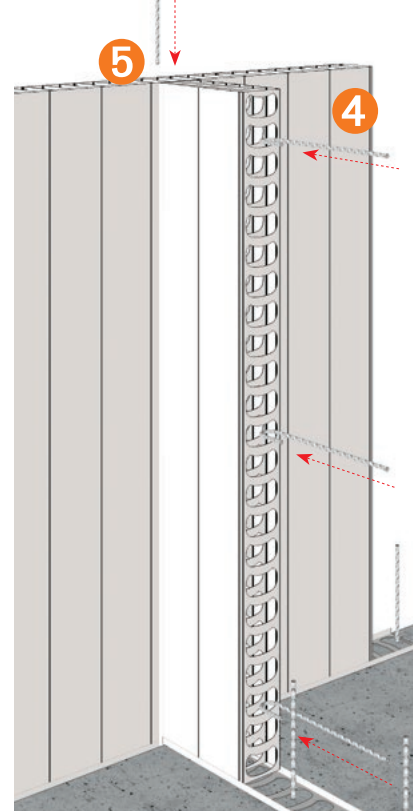

## Obtuse Corner Construction

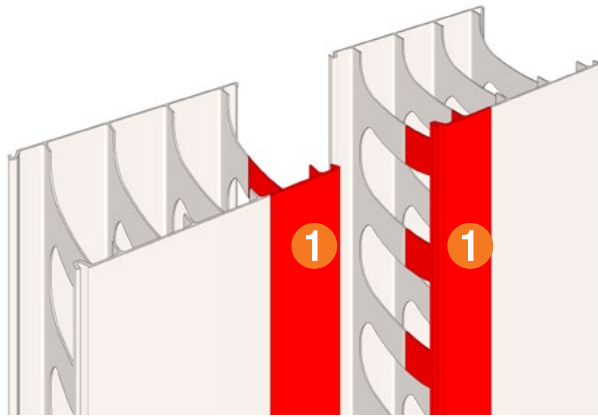

- 1 Cut the required angles from two standard panels.
- 2 Prepare floor track to accept obtuse angle panels. Mitre cut the floor track to make the required angle. Fix the floor track as per earlier instructions in this guide.
- 3 Install wall section up to the corner panels. Fix and brace.
- 4 Install the two cut panel pieces and screw fix to bottom track.

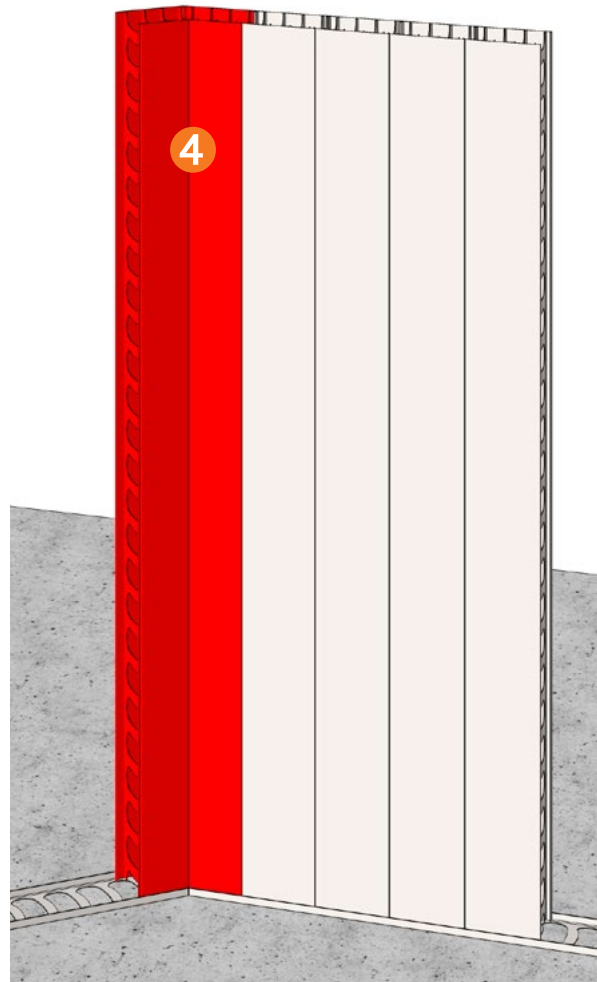
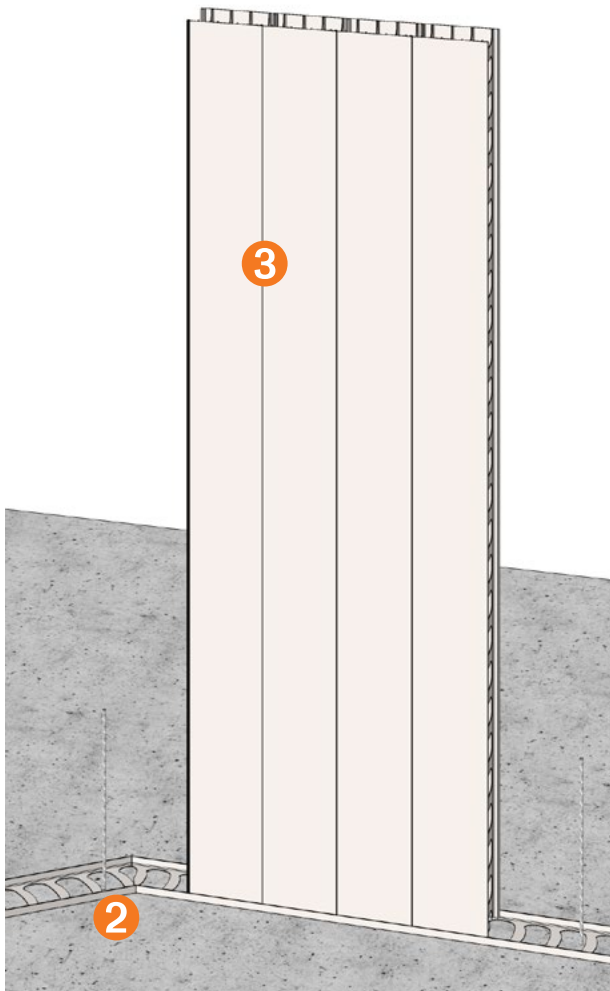

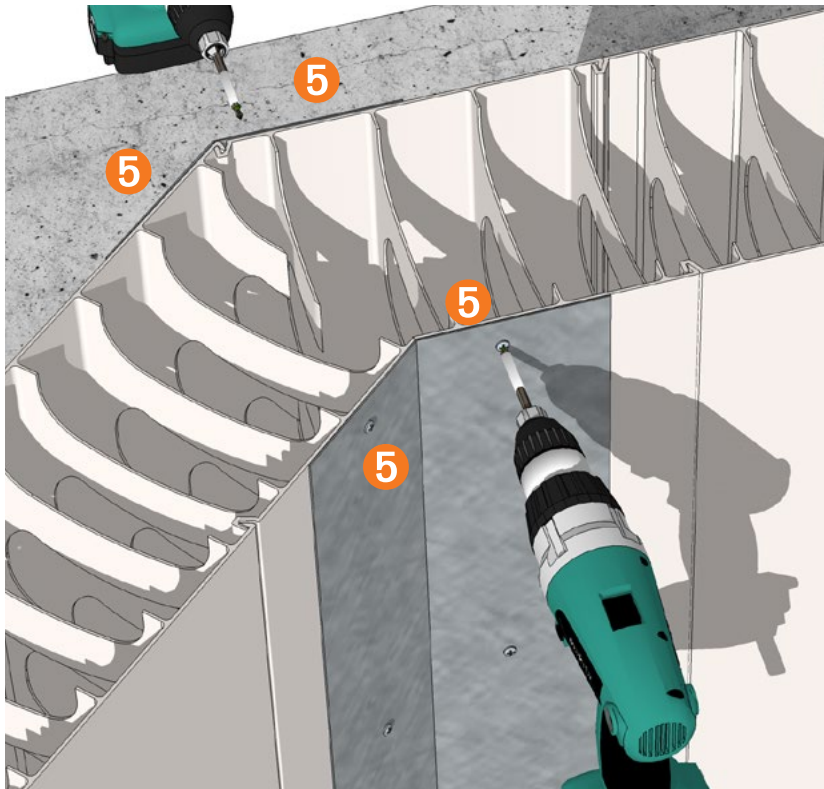

**5** Screw fix appropriate colorbond steel angle squints at maximum 150mm centres to both sides of the internal and external corner junctions.

**6** Continue with standard wall installation and wall bracing.

NOTE: Additional treatment may be required for a waterproof solution. Refer to the Project Engineer for details. Galvanised squints angles are available for 45° corners only.

**7** For angles other than 45° the corner joint must be fully braced with PLY and LVL timber.

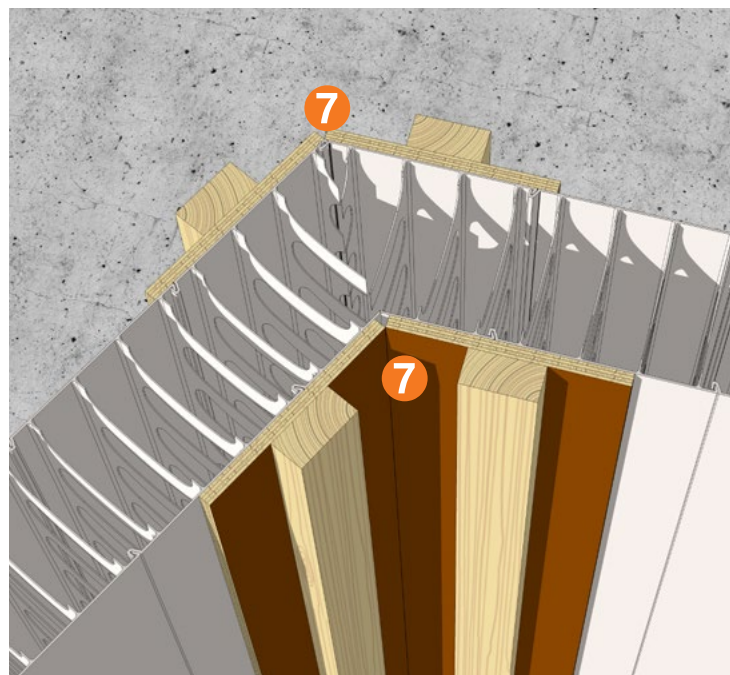
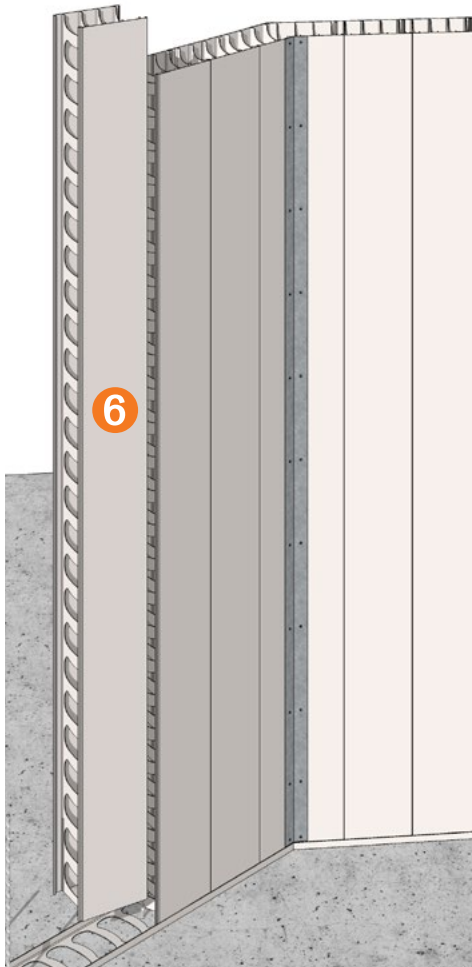

## H-Joiner Installation

### Joining Walls with an H-Joiner

During the course of a rediwall® installation, it is likely that you will be required to join two male or female wall profiles or cut panels or will need to close a small gap in the wall panels.

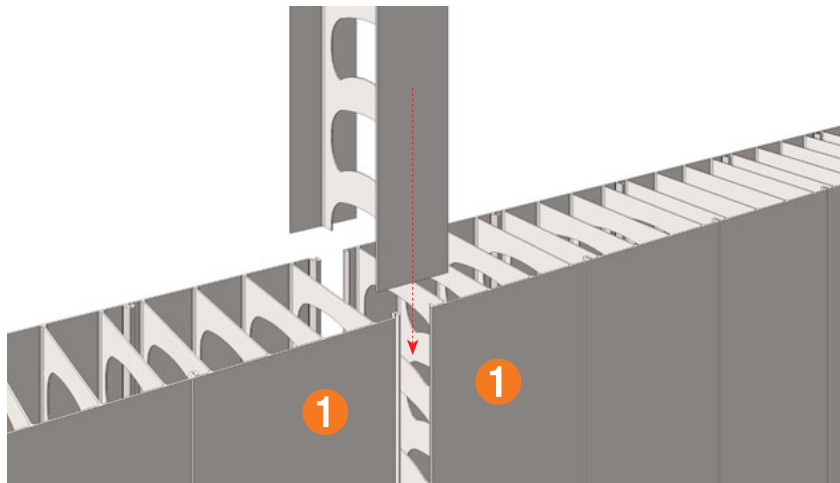

**1** Align the panel ends correctly and ensure the gap is suitable for the use of an H joiner.

**2** Run a bead of silicone down the inside of all four flanges of the H-Joiner. This will help seal and hold the H-Joiner in place.

**3** Screw fix each H-Joiner flange with screws, at 150mm centres. Repeat on both sides of the wall.

**4** Brace as per a standard wall section.

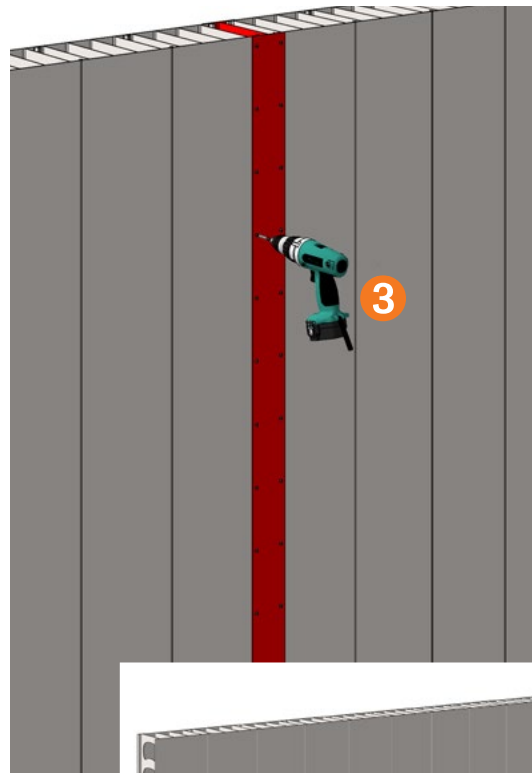
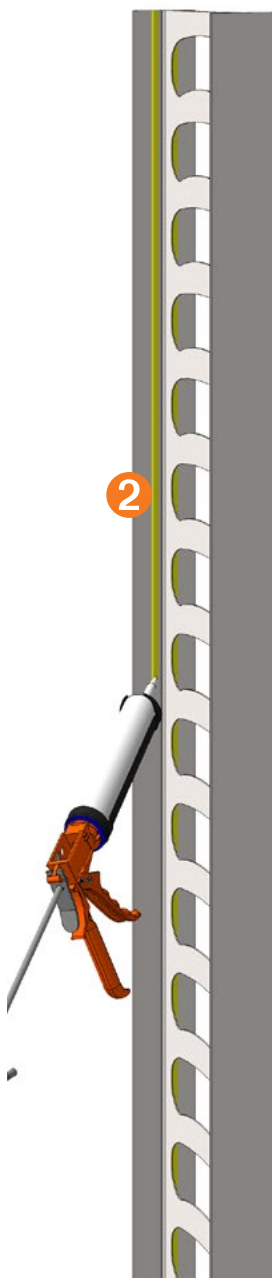



## H-Joiner Installation (Limited Site Access)

### Joining Walls with One Side Access

When site access is limited and an H-Joiner is required, pre-assembly of the wall section to be install may be required.

**1** Install the H-Joiner and the adjacent panels. Cut the panels if required to ensure the wall sections fit together. Allow an overlap of the H-Joiner and the

panel for screw fixing. Mark the panel fixing locations and remove the panels.

**2** Apply sealant to the H-Joiner then assemble to the adjacent panels and screw fix both sides at 150mm centres. (See previous page for details).

**3** Slide the panel assembly down into place and fix as per the standard method.

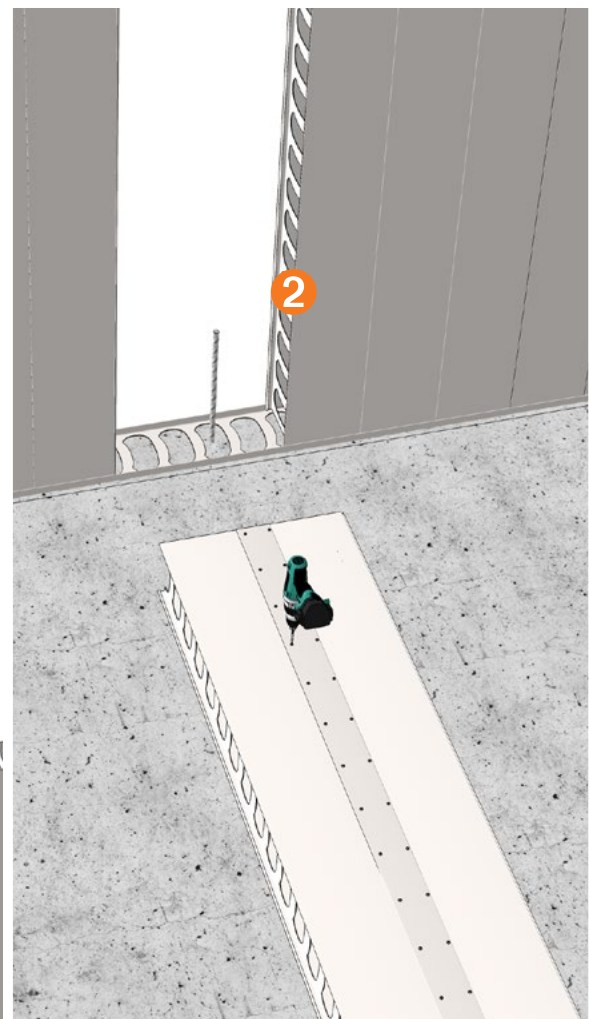
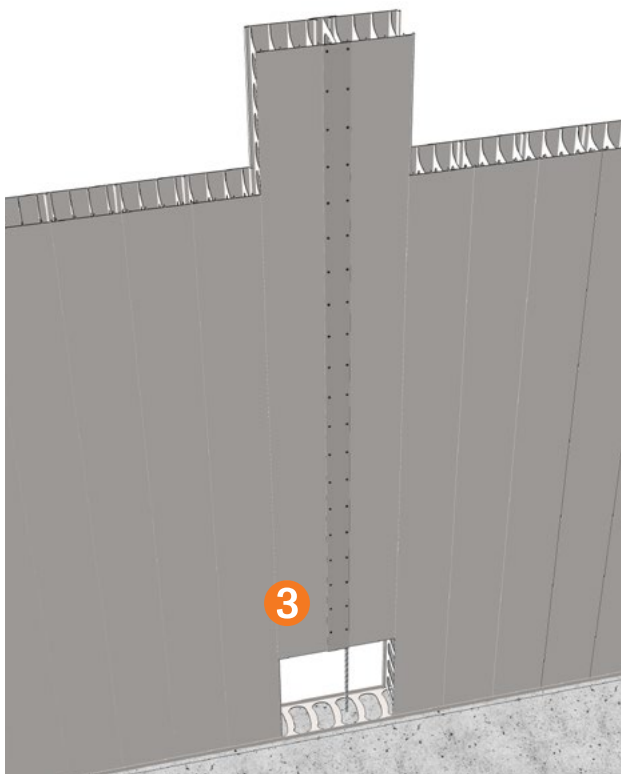
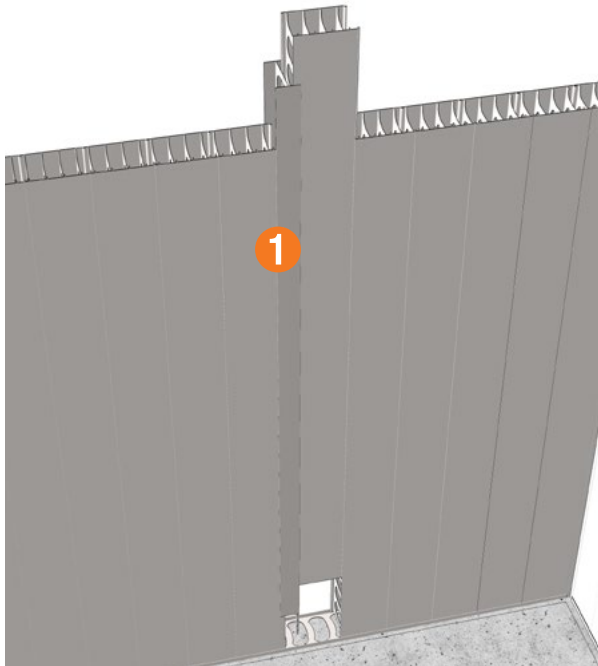

## Accessory Extensions

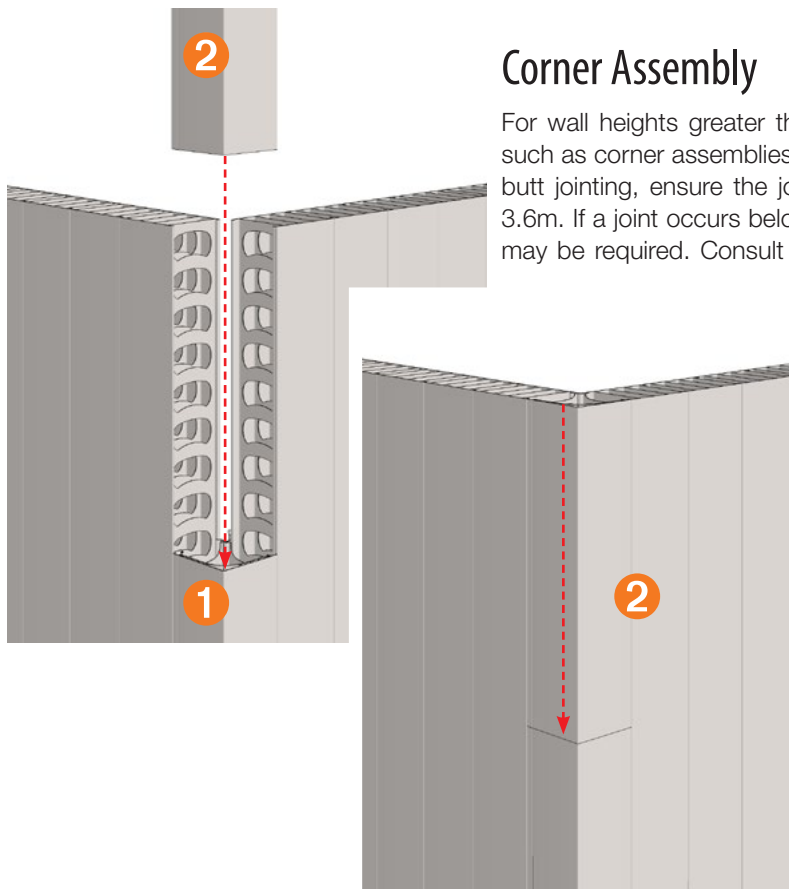

### Corner Assembly

For wall heights greater than 3.6m, butt jointing of components such as corner assemblies and H-Joiners may be required. When butt jointing, ensure the joint occurs as high as possible, i.e. at 3.6m. If a joint occurs below the water table, additional treatment may be required. Consult the Project Engineer for waterproofing details.

- 1 Install the first corner assembly to a height of 3.6m.
- 2 Trim the additional corner assembly to the required height and slide into place. Fix as per standard corner details.

Note: Care should be taken when cutting to ensure the holes align for reinforcement placement.

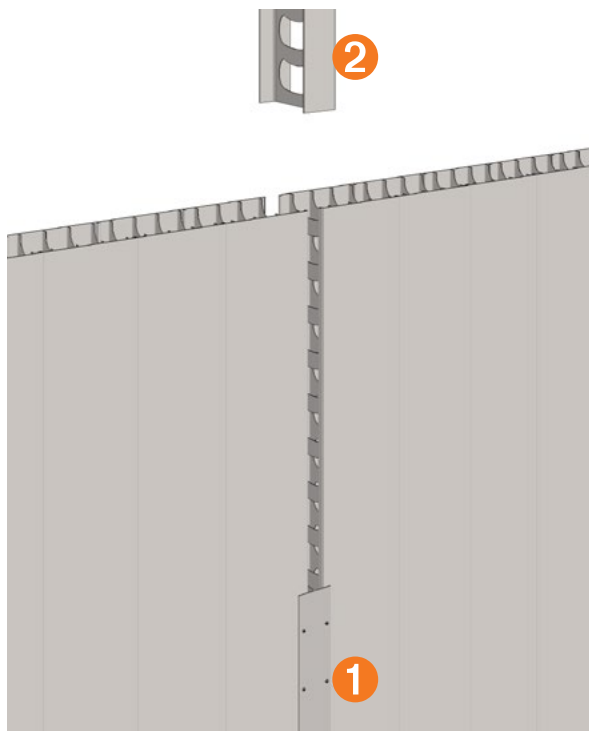

### H-Joiner

- 1 Install the first H-Joiner to a height of 3.6m as per the standard installation details.
- 2 Trim the additional H-joiner to the required height and slide into place. Screw fix as per the standard installation method.

Note: Care should be taken when cutting to ensure the holes align for reinforcement placement.

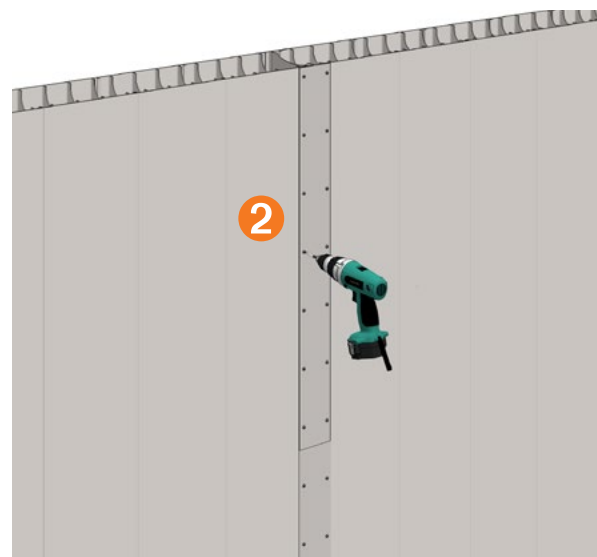

## End Cap Installation



### PVC End Cap

**1** Wall ends or openings can be capped using the rediwall® PVC end cap. Trim the end cap to the required length and slide it onto the wall end being capped.

**2** Screw fix each side with screws, at 150mm centres.

**WARNING:** End caps are to be braced for the full height. Refer to "Bracing End Caps" for details.

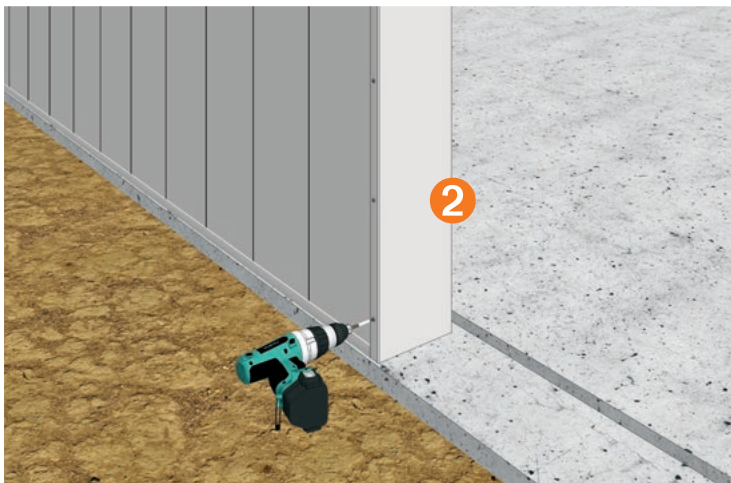

### Fibre Cement Strip

Alternatively, 9mm and 12mm thick fibre cement strip can be used in lieu of the PVC end cap. Fibre cement strips are available from AFS.

**3** A female/female joiner can be used to convert one panel end to female. The female/female joiner should be installed at least one panel in along the wall..

**4** Cut the fibre cement to length and slide into place behind the clips, of the end panels, as shown.

**WARNING:** The wall end must be braced for the full height.

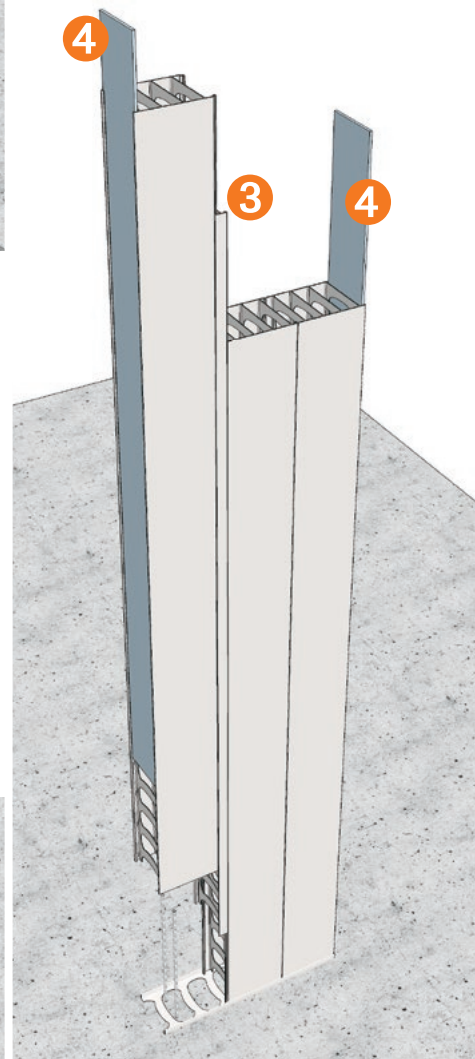
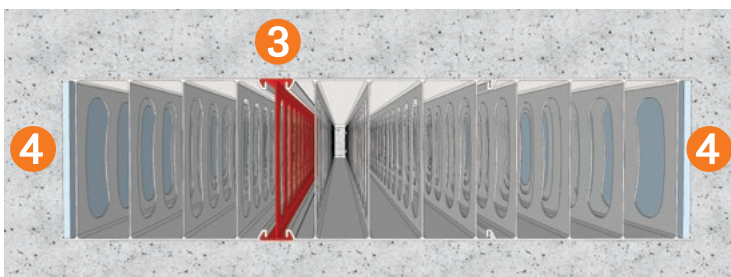

## RW256S, RW275S and RW300S Blade Walls

### Blade Walls

**1** When installing an RW256S RW275S or RW300S blade wall, a floor track (RW256S only), 50x50mm angle or other is used. Fix the base to the slab at 450mm maximum centres. Place the first panel at the end of the floor track and screw fix to the track.

**2** Slide additional panels together until the blade wall

is complete. Screw fix all panels to the floor track at the panel joins. Any reinforcement bars required should be slid into place before installing the end caps.

**3** A female/female joiner is required to reverse the panel end in order to install a QuickCap or fibre cement strip. The female/female joiner should be installed at least one full panel in from the end of the wall.

**4** Finish the end of the blade wall with a fibre cement strip (as shown) or alternatively End Cap (RW256S only), Quick Cap (RW256S only).

**WARNING:** End caps are to be braced for the full height.

Note: A timber kicker can also be used for alignment and containment of the base of the blade wall.

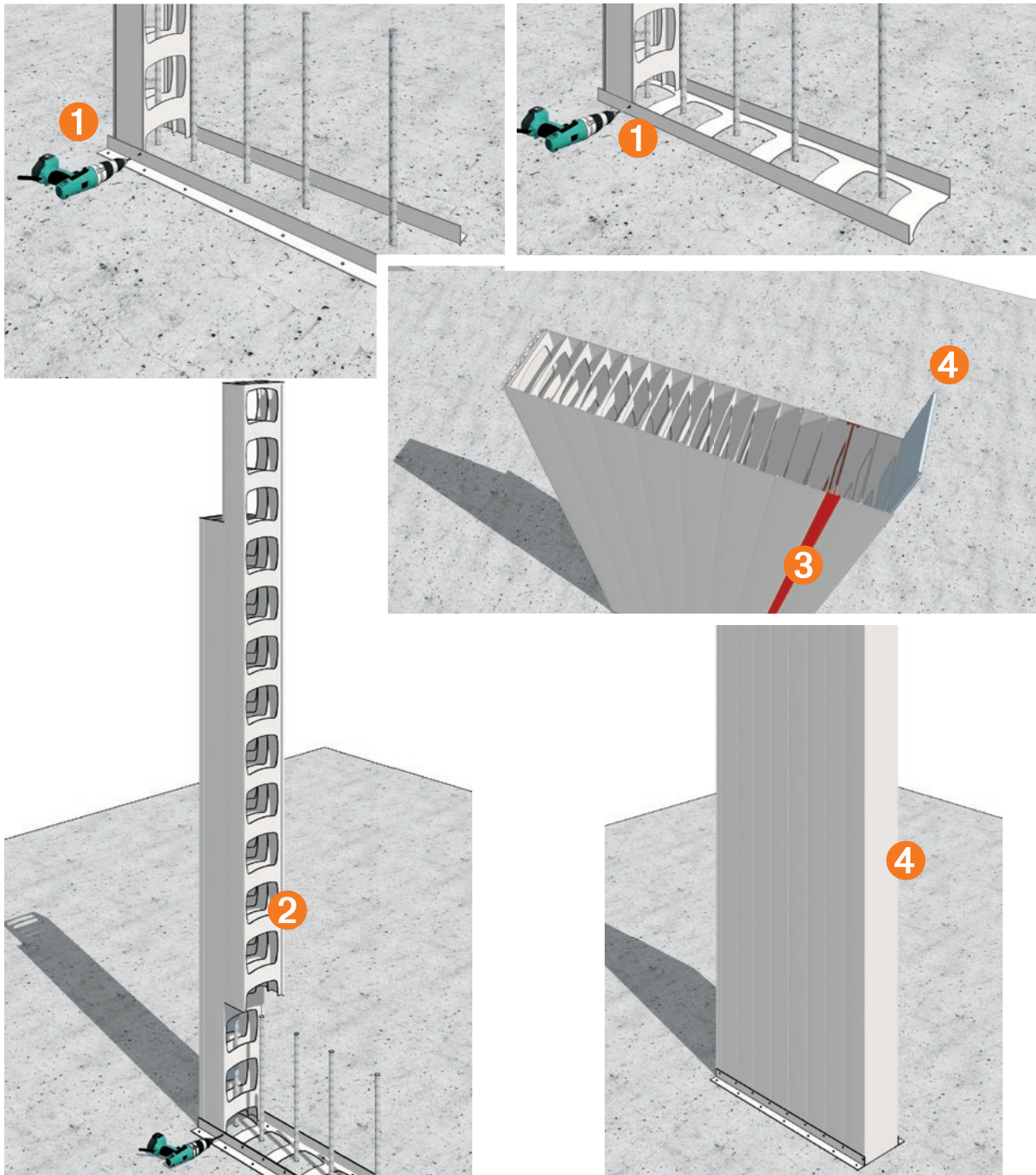

## Column Construction

### Rediwall® Floor Track and Panel Fixing

- 1 Position the Rediwall® floor track or angles at the correct column location and fix the track to the slab.
- 2 Screw fix each Rediwall® panel to the floor track on both sides of the panel.
- 3 Vertical bar locators (VBL) and alignment bars can be used to assist with location and installation of the vertical reinforcement. Once sufficient number of Rediwall® panels are fixed in place, fix the VBL to the inside web face of the afs rediwall® panel at the desired locations of the vertical bar alignment guides.

4 If using the RW200C FF Column Panel, it is recommended that it be used at least 1 full panel from the end of the column. The RW200C FF Column Panel **CANNOT** be used as the end panel.

5 If VBL are used, slide the alignment bar (R10) through the VBL.

**Note:** These guide bars are **NOT** to be considered as part of the wall structural reinforcement.

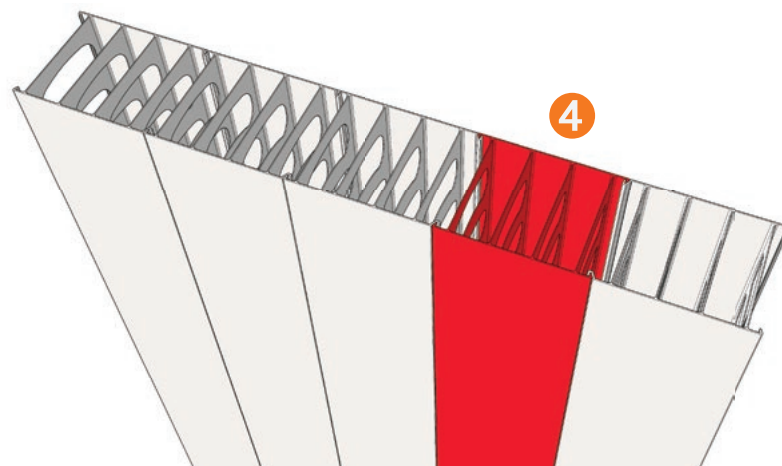
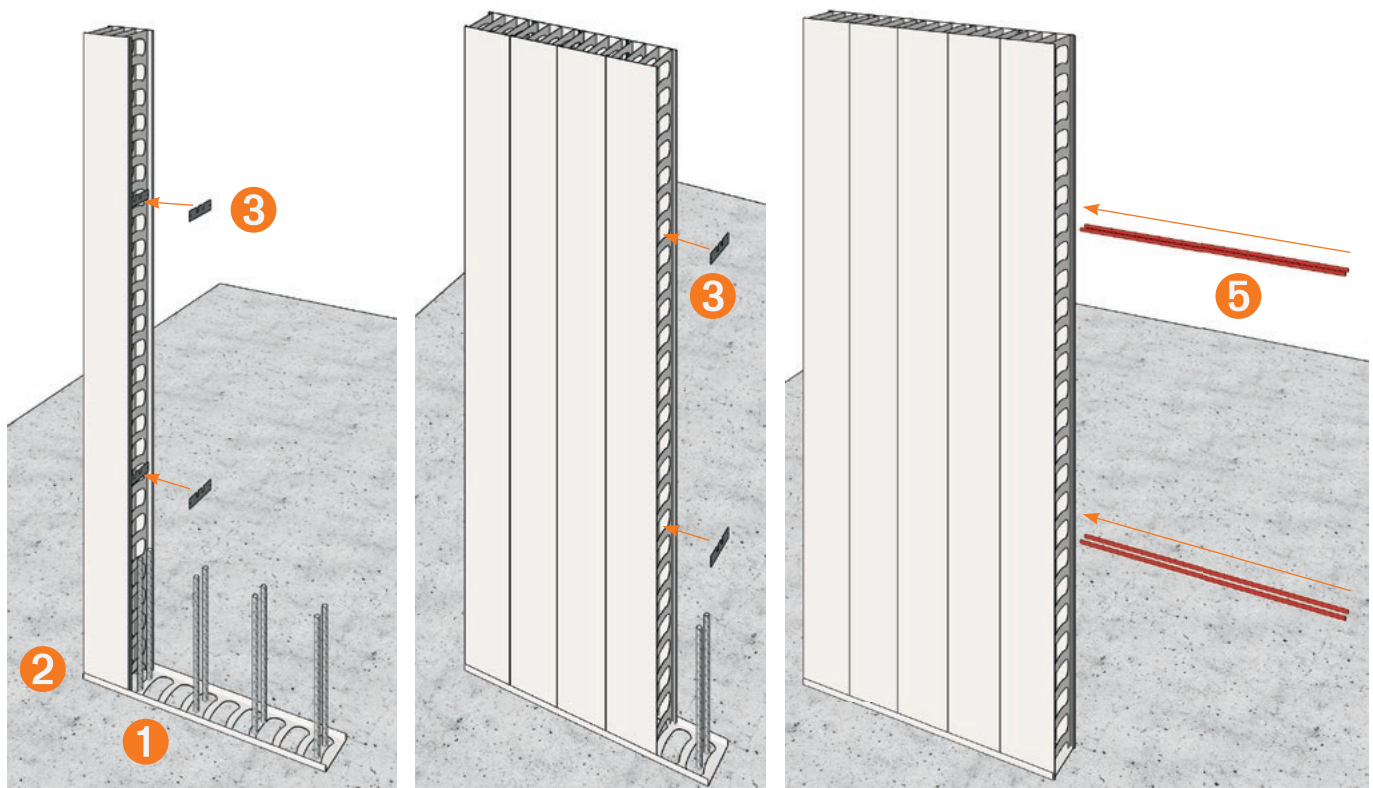

## U-bar Installation

### U-Bar Installation

- 1 Insert the U-Bars into the Column at the required spacings. Refer to engineers details.
- 2 The vertical reinforcement bars are then lowered into the Rediwall® panel, at the correct locations. Ensure that the vertical bars are on the internal side horizontal U-bars, and on the outer side of the alignment bars.

**Note:** A small 20mm bend at the base of the vertical bar can be used to “joggle” the bar past the horizontal bars.

The offset makes it easy when lowering the vertical reinforcing bars into the wall to weave it in between the locator bars and the outer horizontal reinforcing bars.

A mark on the vertical joggle bars can facilitate locating the alignment bars so that the joggle bars can be paused just above the horizontal locator bar can speed up reinforcement installation.

- 3 Insert the two fibre cement end caps into the Rediwall® panel clips. Ensure that the column is fully braced.

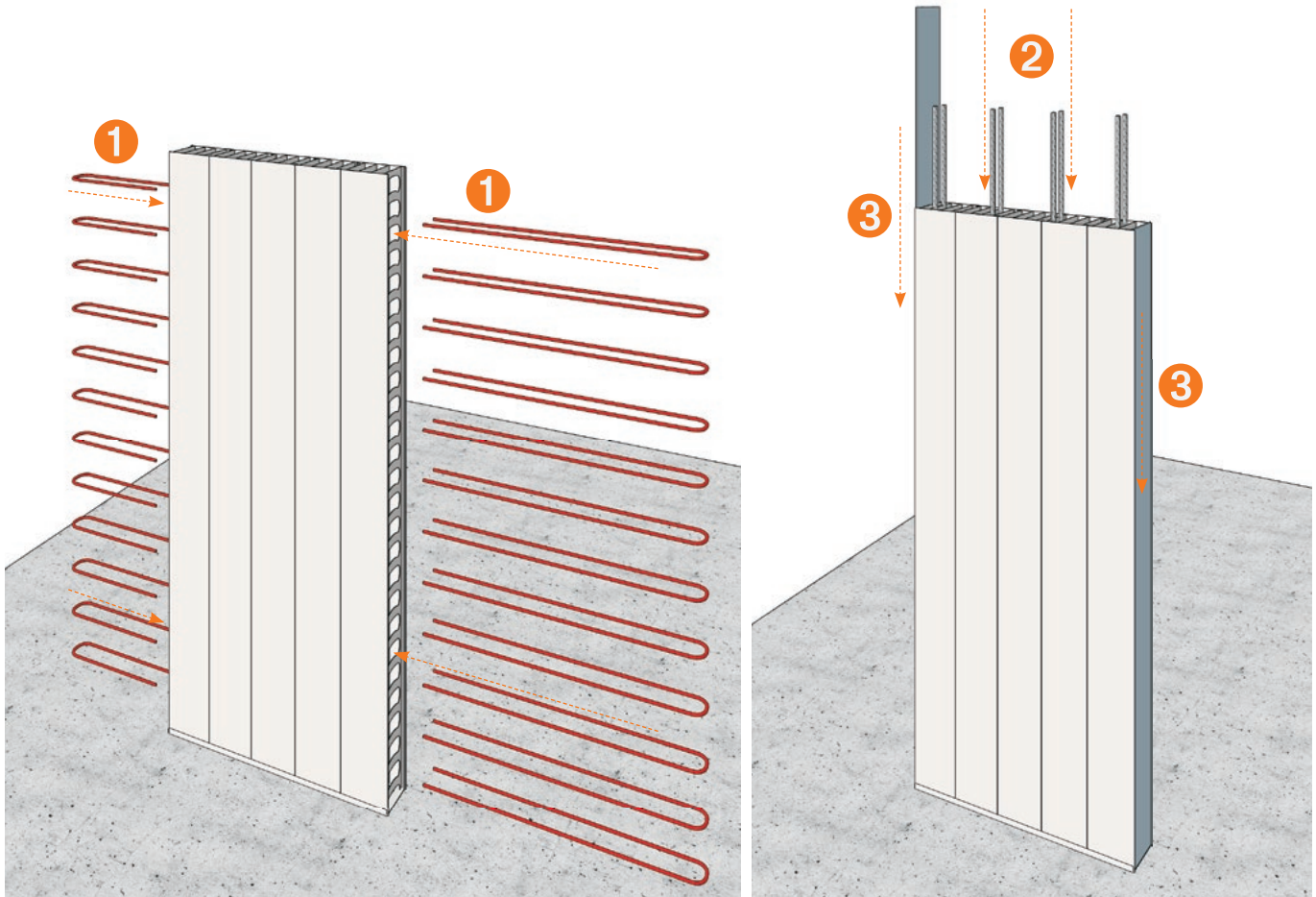

## Rediwall® Edge Form

### Rediwall® Edge Form

**1** Once the wall has been installed and the formwork deck is in place, use a grinder to cut out the top edge section of the rediwall® panels.

**2** Additional bracing is required along the edge form section. See edge form bracing in this manual.

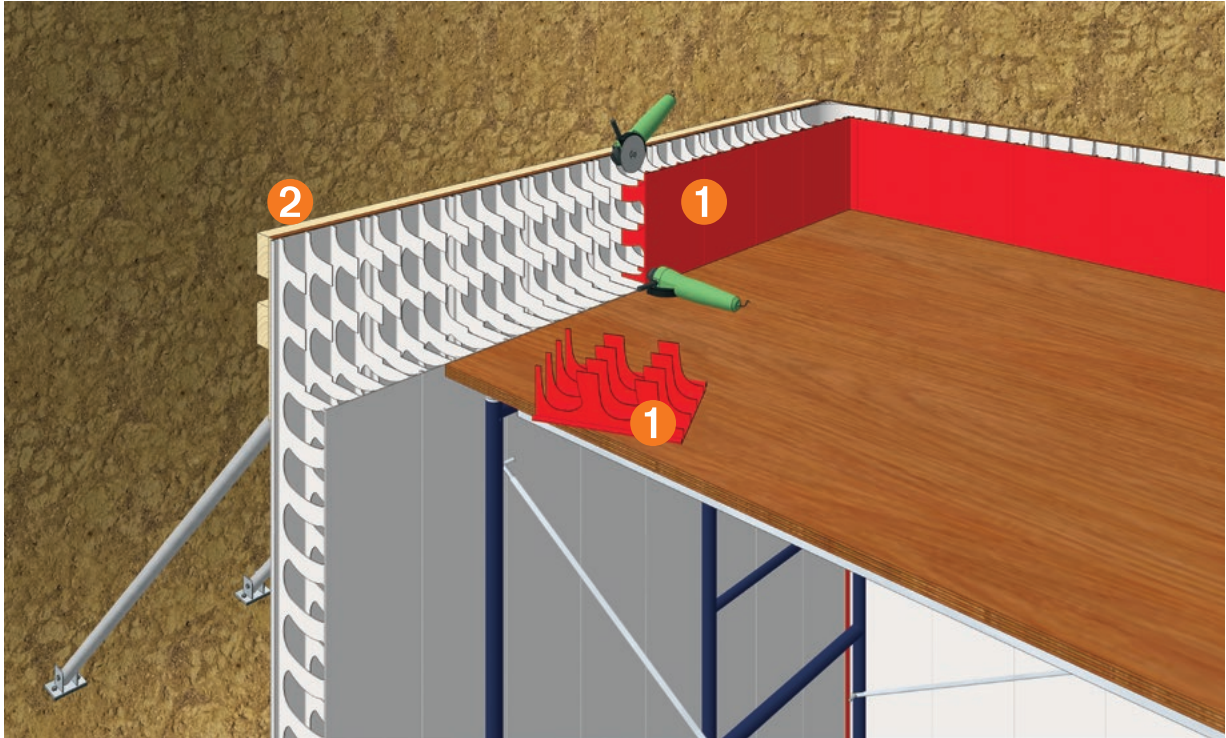

## Rediwall® J-Track Installation

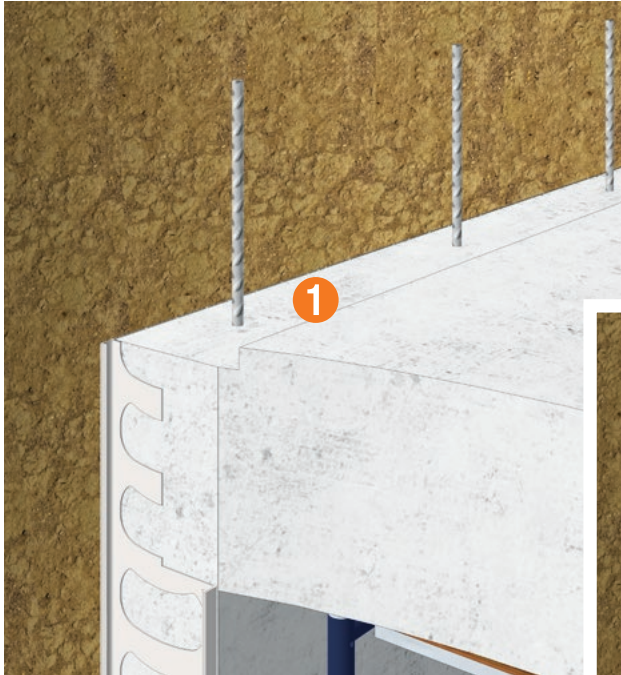

- 1** Ensure that the suspended slab surface is free from debris and the level is checked and corrected as required. The Project Engineer should be consulted in relation to correct starter bar placement.

### J-Track

When continuing a wall to another storey, J-Tracks are used as floor track at the junction of the upper wall and suspended slab (e.g. stair shafts, lift shafts and external walls). For external walls, waterproofing details for this junction are to be determined by the Project Engineer.

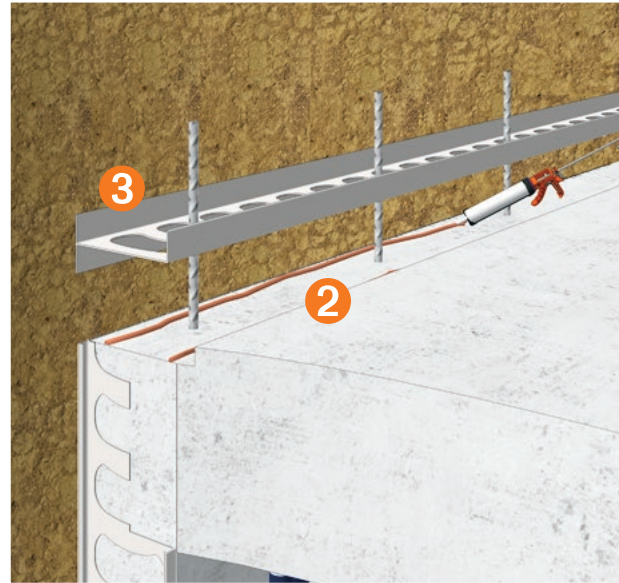

- 2** Two beads of polyurethane sealant or as per waterproofer's details, must be applied in accordance with the manufacturer's instructions under the rediwall® floor track (one on each side of the track) on all external walls.

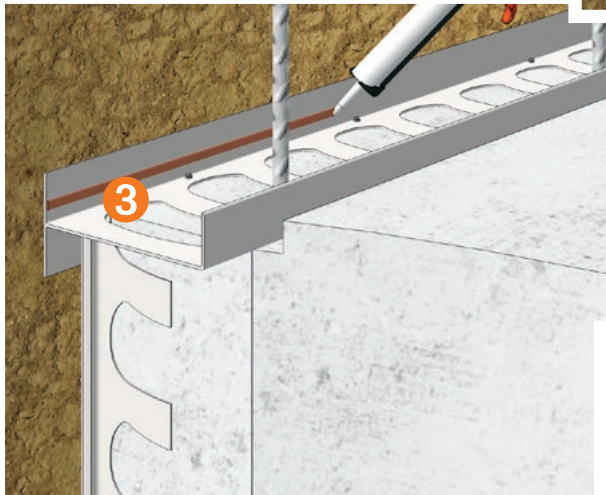

- 3** Rediwall® J Track is then placed in the required location and fixed to the concrete slab using a masonry fixing gun or drill and anchor masonry fixing system. Fix with fasteners each side of the track at 500mm centres for walls up to 5m height, or at 250mm maximum centres for walls over 5m height.

- 4** Start the new wall as per the standard wall construction method in this manual. Ensure any bracing is adequate for multilevel construction, refer to the Project Engineer for details.

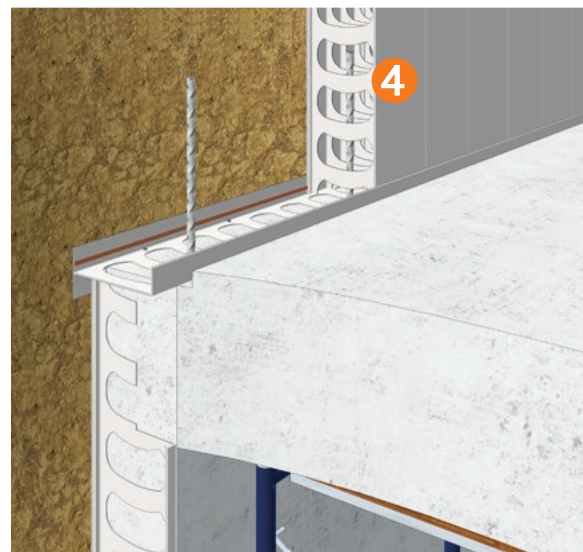



## Window Openings

### Sills and Lintels

Rediwall® PVC End Cap is used for closing off at the underside of lintels and at the sides of openings. Lintels can be built into the wall or cut out of the installed panels.

#### WARNING

It is imperative that all lintels and openings are provided with sufficient support to withstand the weight of concrete prior to core filling. Refer to the Bracing section on for details.

- 1 Install sill panels as per site plan. AFS recommends installing 2 or 3 additional panels on the side of the sill as per normal panel installation.
- 2 Install End Cap to the sides of the opening to the required height and screw fix at 150mm centres each side of the wall.

Alternatively, panels can be cut to suit opening width.

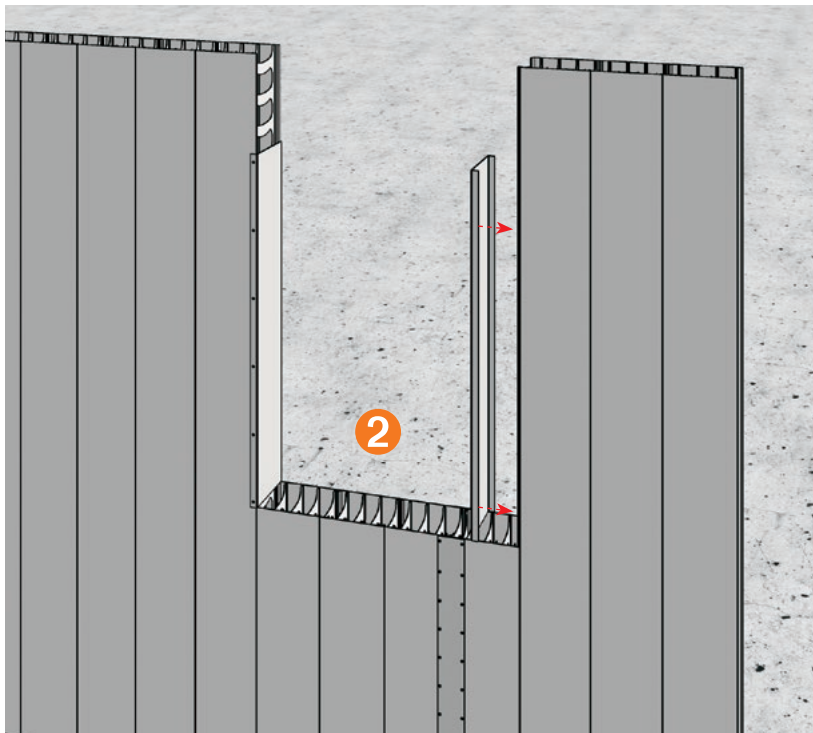
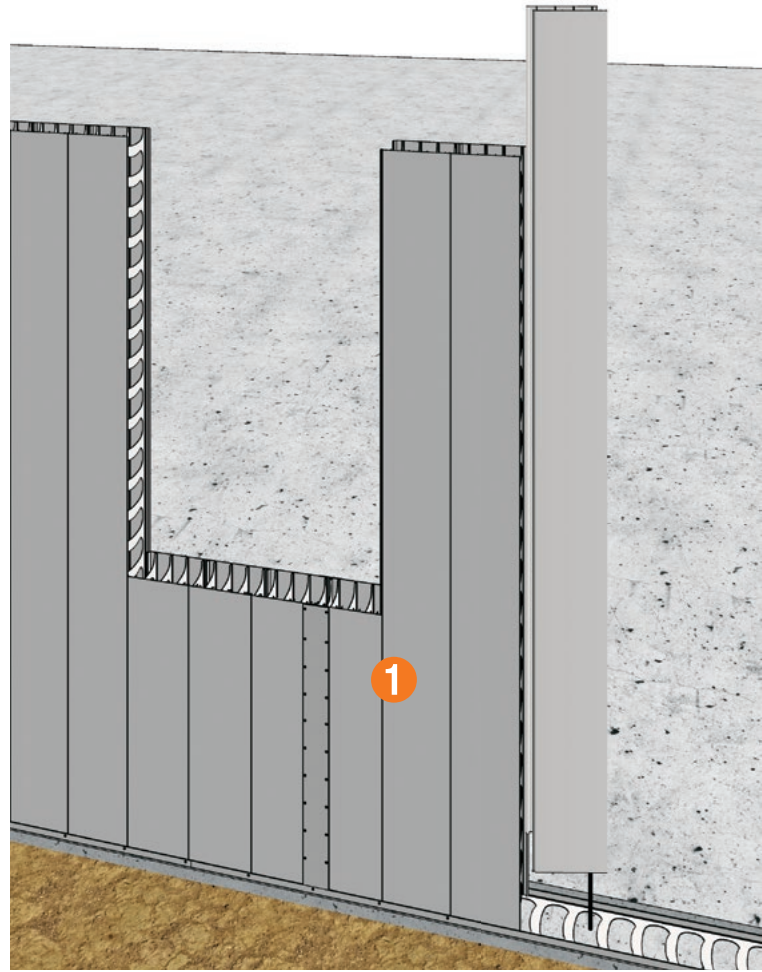

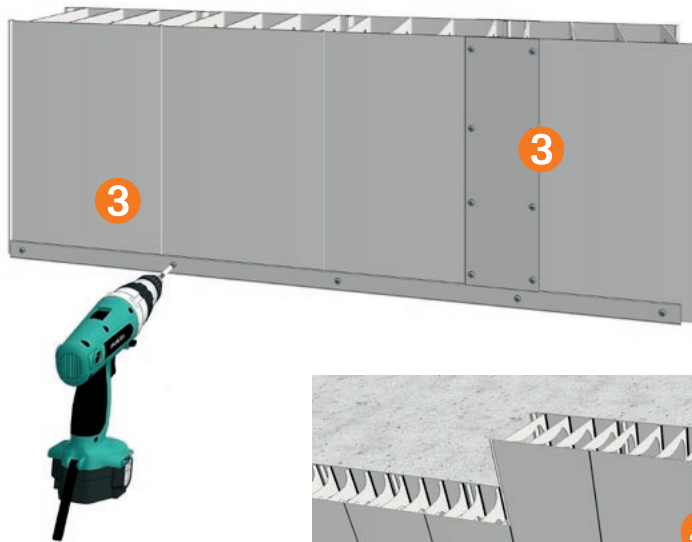

**3** Assemble the lintel section separately. Fit End Cap to the bottom of the lintel panels and screw fix on each side of the wall at 150mm centres. Cut End Cap to allow for interlocking with adjoining panels on both ends. H-Joiners may be inserted to make up the correct distance and screw fixed at 150mm centres to both adjoining panels.

**4** Slide the lintel assembly into position and screw fix in place at each end of the lintel and on both sides of the wall at 150mm centres.

**5** Trim the sill panels to create a 5° fall to the outside face of the wall.

**6** After core filling, remove end caps as per architectural details.

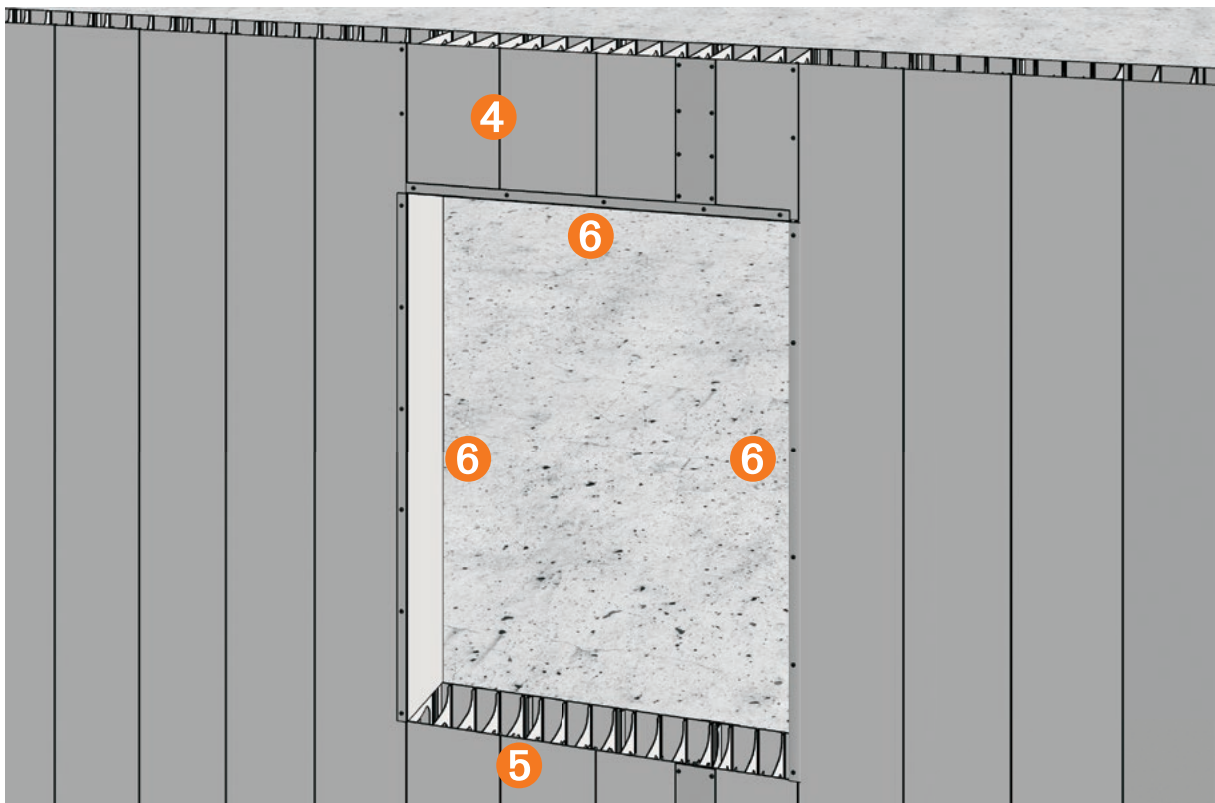
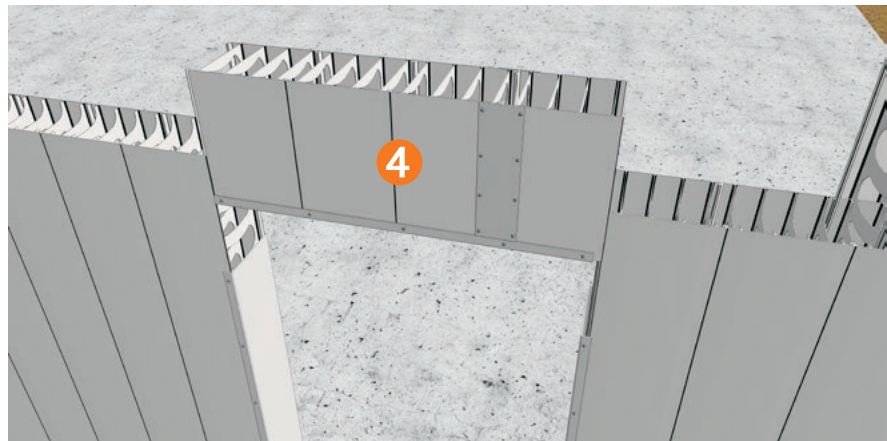

## Doorway & Lintel Installation

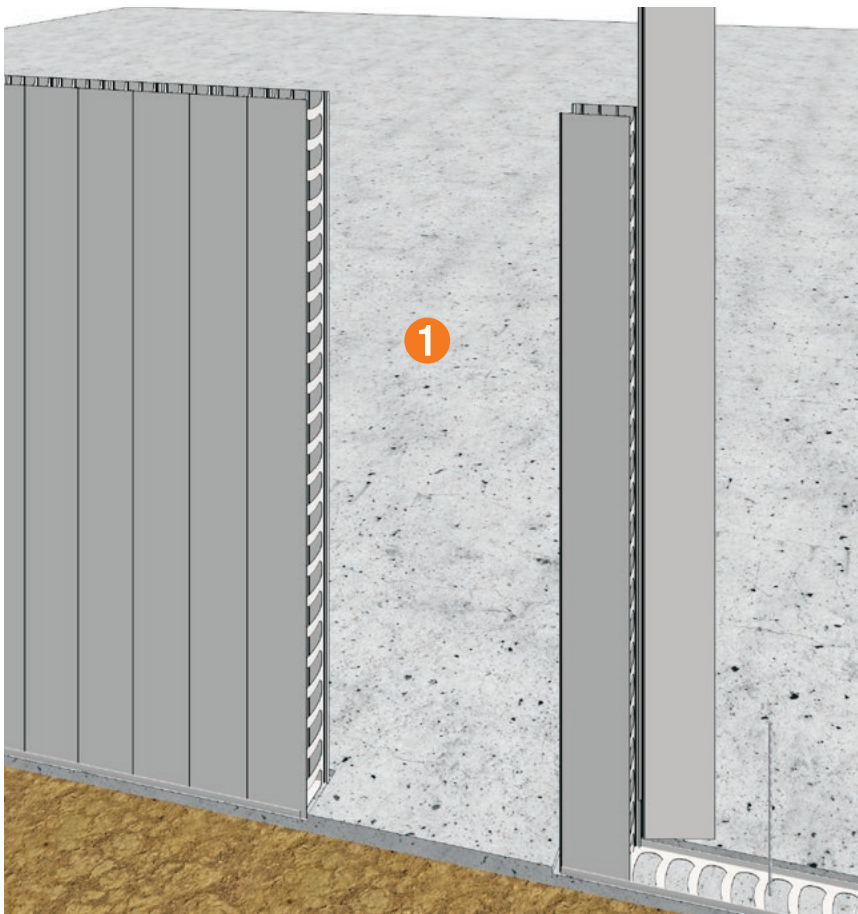

### Doorway with PVC Capping

Rediwall® PVC end cap is used for closing off at the base of lintels and at the sides of openings. Doorways can be built into the wall or cut out of the installed panels.

It is imperative that all lintels and openings are provided with sufficient support to withstand the weight of concrete prior to core filling.

**WARNING:** All openings are to be braced. Refer to the bracing section for details.

**1** Install wall panels as per site plan. AFS recommends installing at least three panels on each side of the opening as per normal panel installation.

**2** Install End Cap to the sides of the opening to the required height and screw fix to both sides of the wall at 150mm centres.

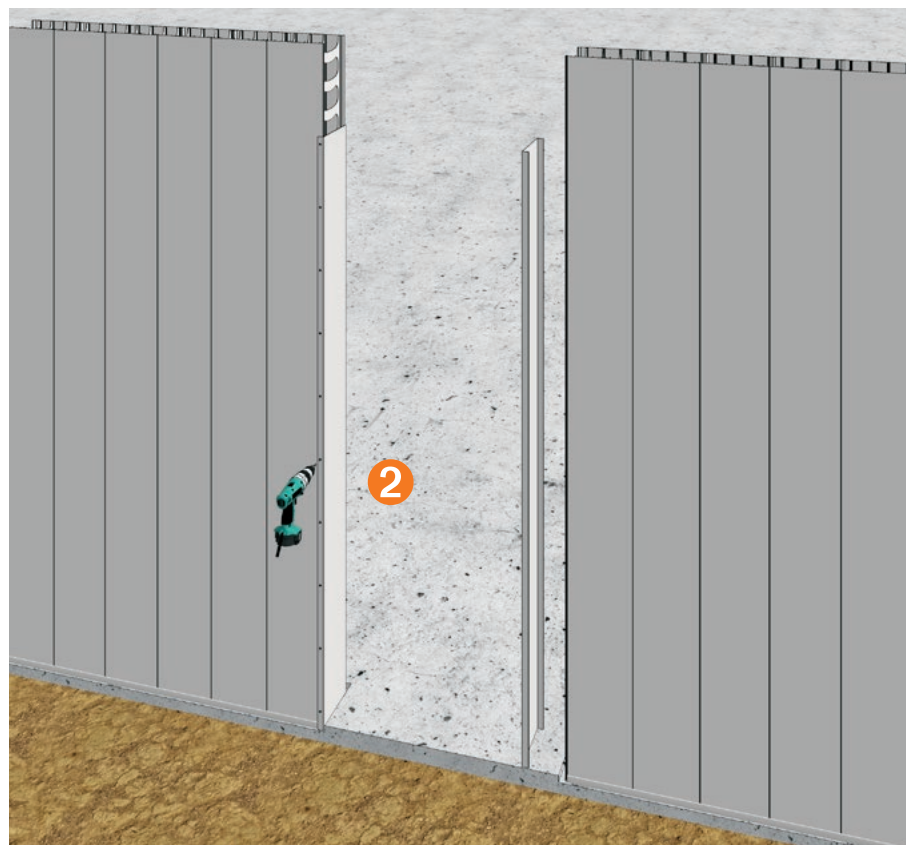

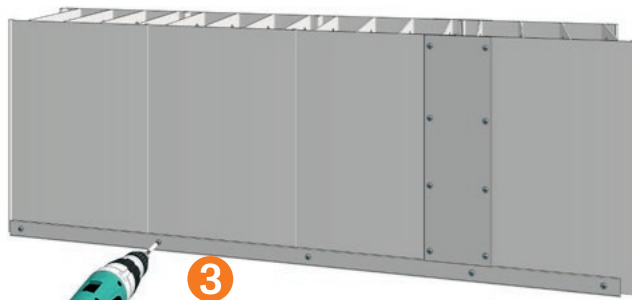

**3** Assemble the lintel section separately. Fit End Cap to the bottom of the lintel panels and screw fix on each side of the wall at 150mm centres. Cut End Cap to allow for interlocking with adjoining panels on both ends. H-Joiners may be inserted to make up the correct distance and screw fixed at 150mm centres to both adjoining panels.

**4** Slide the lintel assembly into position and screw fix in place on both sides of the wall and at each end of the lintel at 150mm centres.

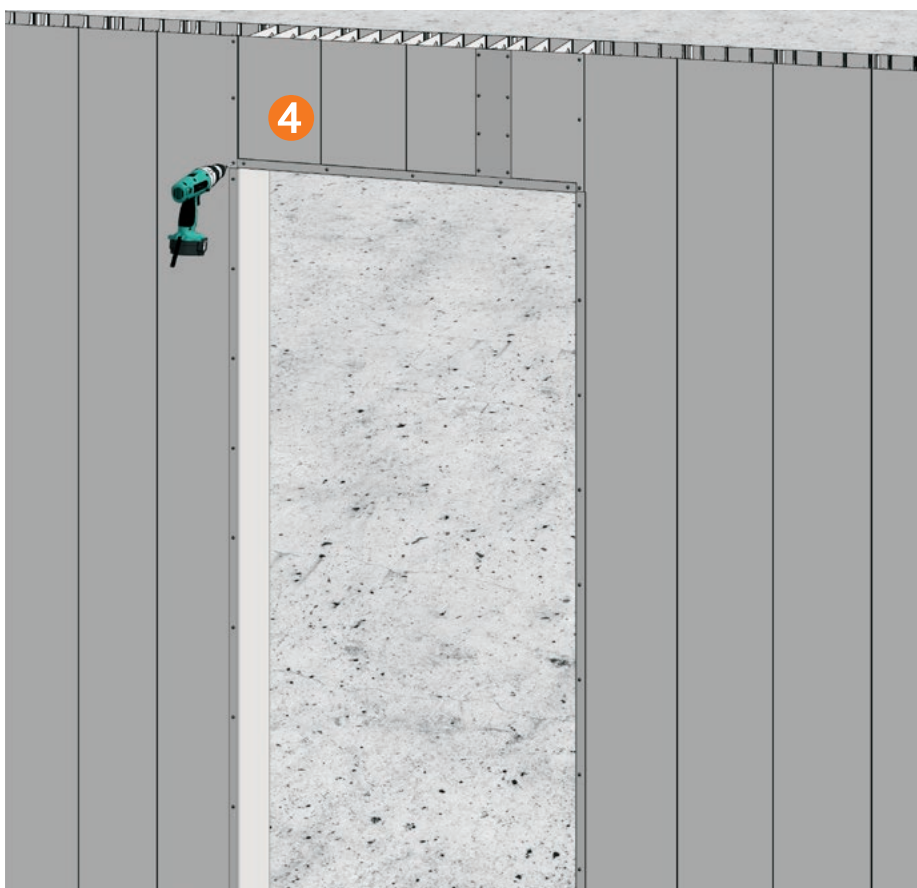
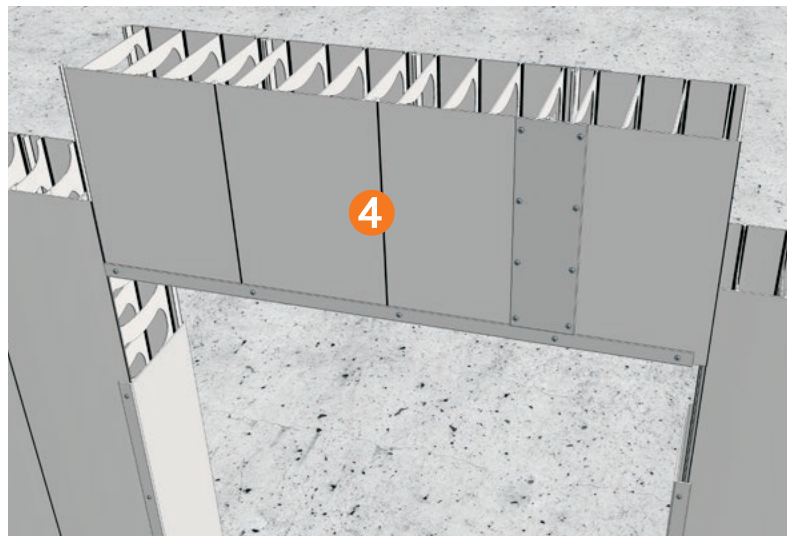

## Doorway with Steel Frame (Internal Fit Jamb)

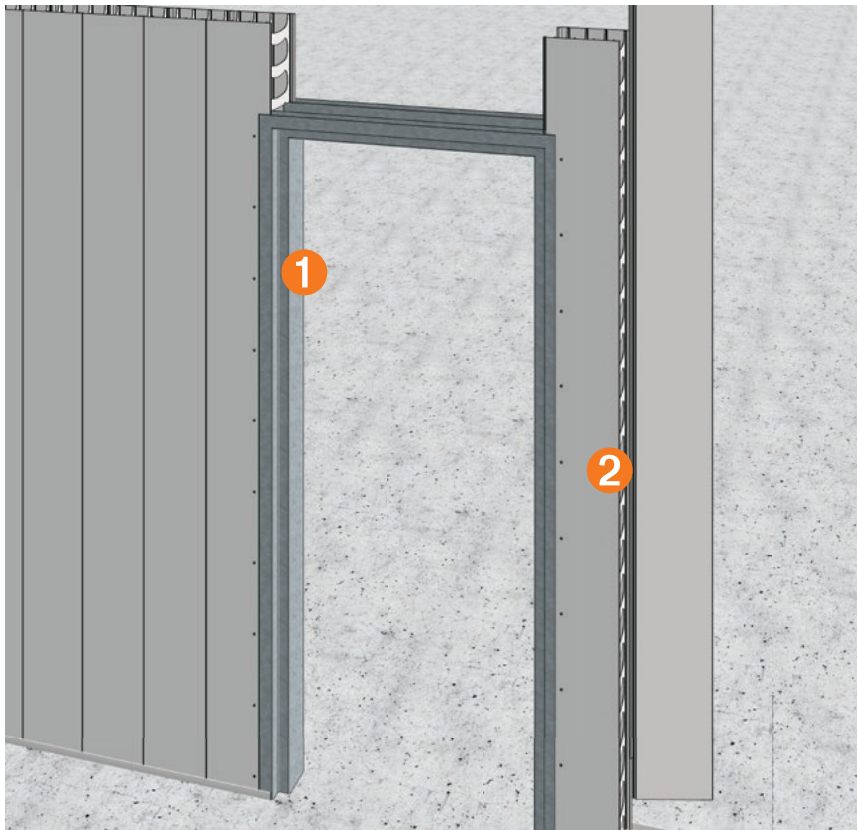

**WARNING:** All openings are to be braced. Refer to the Bracing section on for details.

**1** Where a metal door frame is to be fitted, the frame is slid into position with the door jamb member inside the rediwall® panel flange. Removal of some of the PVC clip profile may be required to ensure a proper fit. Screw fix at 150mm centres on both sides of the wall.

**2** The next full size rediwall® panel is then placed and engaged in the door jamb member. Screw fix at 150mm centres on both sides of the wall.

**3** Lintel sections are then slid into place above the door frame. Fix in place on both sides of the wall and at each end of the lintel using screws at 150mm centres. Removal

or slitting of the panel webs may be required to ensure correct fit.

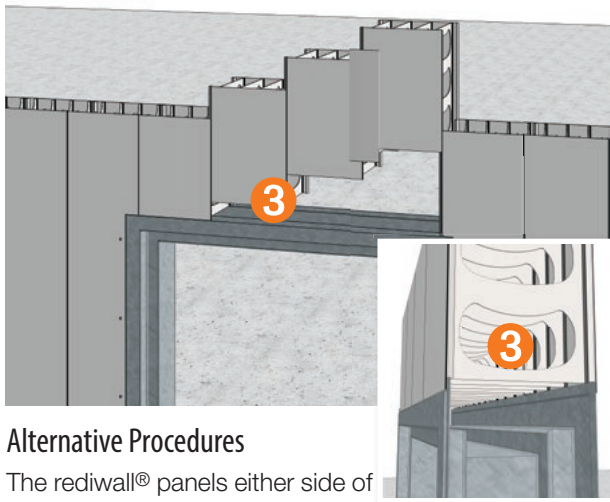

### Alternative Procedures

The rediwall® panels either side of the doorway are fixed into position, plumbed and braced (ensuring the opening between them is accurate for the frame). The frame can then be lowered between the panels. The lintel panel is pre-assembled on-site and lowered into position, engaging into the panels on both ends and dropping down into the head of the door frame.

### Retro-fitted Doors

Where a doorway is to be retro-fitted with a door frame, the opening is constructed, capped and braced as for a window opening but without any sill panel.

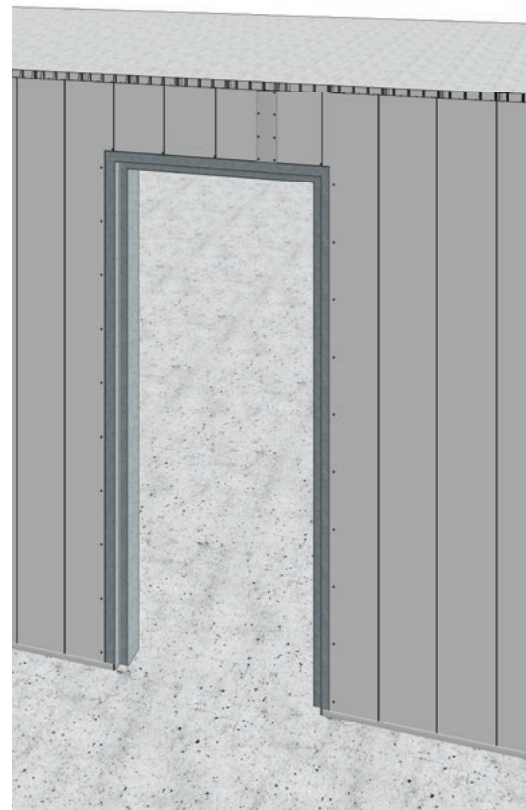

## RW200C 15° Panel – Curved Wall Installation

### Curved walls

- 1 Mark inner radius of the curved wall on the slab or footing.
- 2 Cut the floor track down the middle and bend the track to suit both the inner and outer radius of the curve. Secure in place using a masonry fixing gun or drill and anchor masonry fixing system each side of the track.
- 3 Lower the curved panels into position. Fix each panel to the floor track.
- 4 Install pre-curved reinforcement bars into the curved wall and locate the bars to allow standard lapping of horizontal reinforcement with any adjoining walls. It may be necessary to install further wall panels before installing the curved reinforcement due to reinforcement/panel interference.

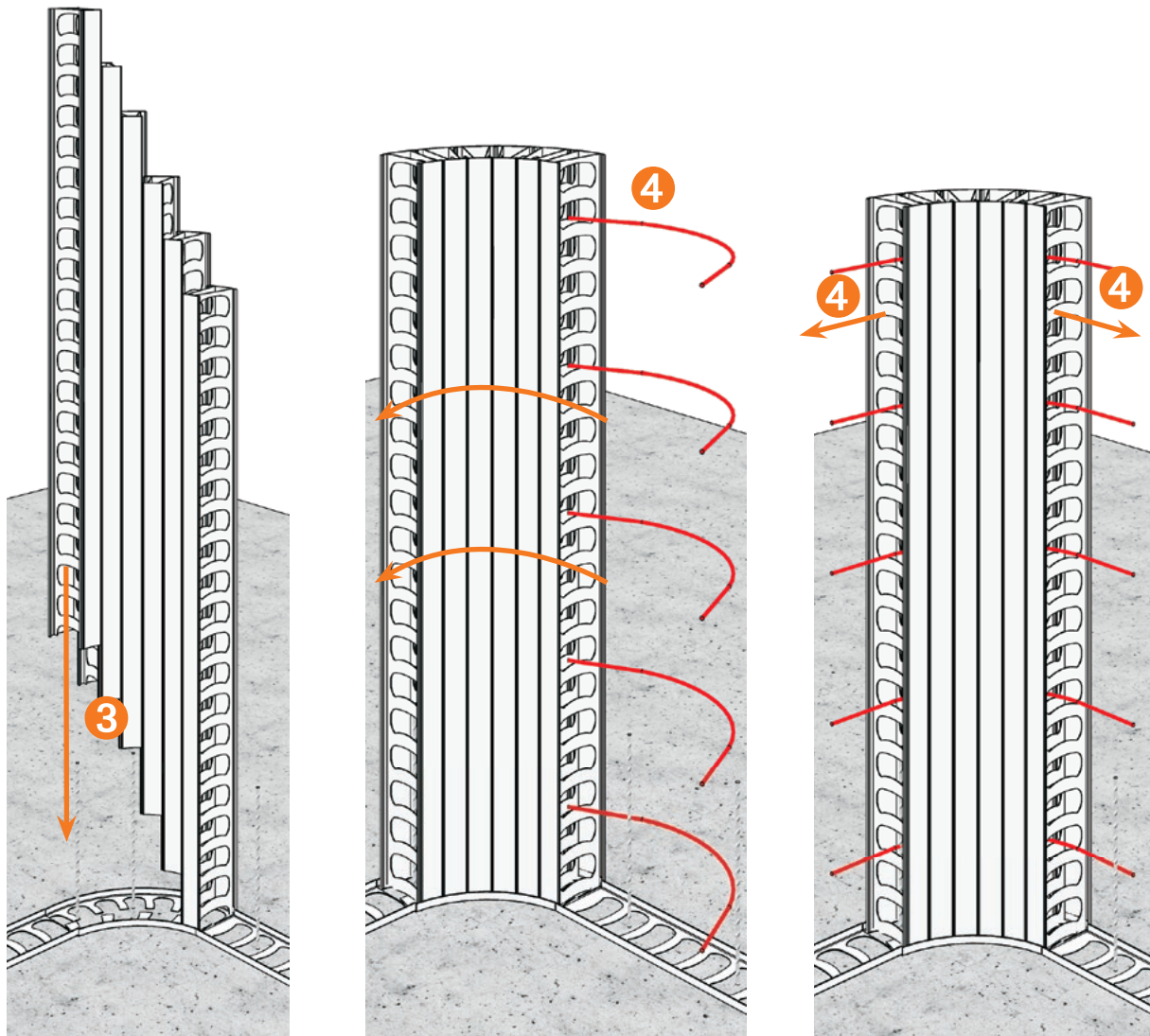

## Wide Radius Curved Wall Installation

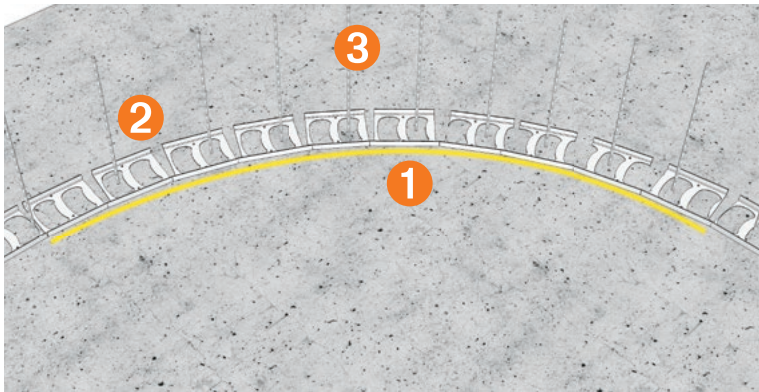

### Curved walls

- 1 Mark inner radius of the curved wall on the slab or footing.
- 2 Slit the floor track on one side only (the convex side of the curve) to allow the floor track to be bent to the shape of the curve.
- 3 Lower the floor track over the starter bars and place into position to the radius required. Fix each track section to the concrete footing or slab using a masonry fixing gun or drill and anchor masonry fixing system each side of the track.

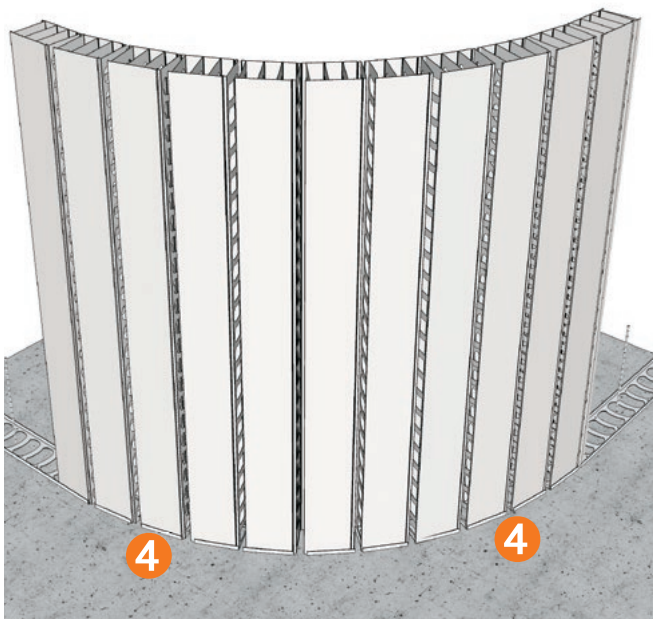

- 4 Begin by installing standard panels into the floor track and screw fix both sides of the bottom of the panel to the floor track at 150mm centres.

- 5 Using H-Joiners as spacers, slide them in between the joins and screw fix them both sides to each panel at 150mm centres to cover a maximum opening of 50mm (38mm for RW200) per joint.

### Alternative Procedures

For walls with a large radius (radius greater than 5m), the panels may be installed to follow the floor track curve without panel modification or any additional components.

After installing the curved floor track, continue the wall by erecting panels in place allowing a small direction change in each wall segment. Screw fix panels to the floor track as erection proceeds.

**WARNING:** Refer to the Bracing section for details.

Additional treatment may be required for a waterproof solution refer to the project engineers for details.

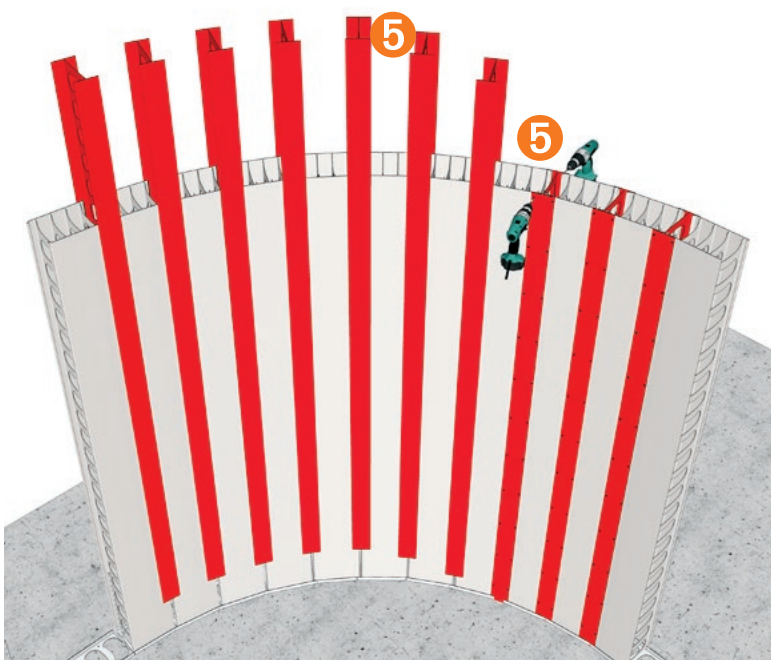

## Curved Wall Reinforcement Bar Installation

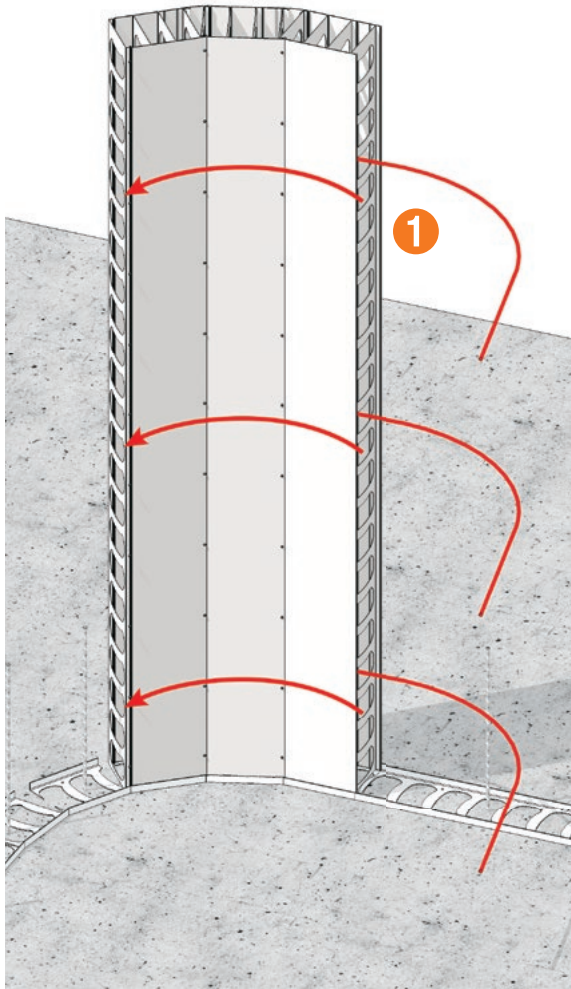

### Installing Pre-curved Bars

If reinforcing bar is to be installed it can be pre-ordered bent to the required radius.

- 1** For wide radius curves – pre-bent reinforcing can be installed from one end of the wall as the panels are being installed.
- 2** Install 1 or 2 more panels on the curve and feed the pre-bent reinforcing into the last installed panel. Continue this procedure until the curve is complete.

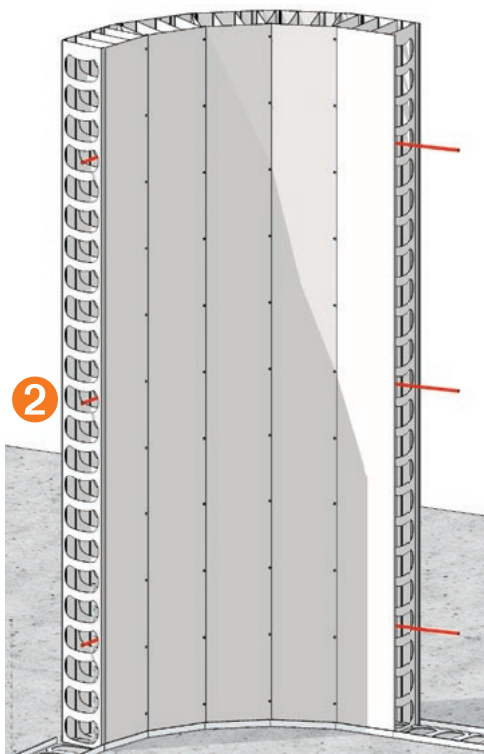
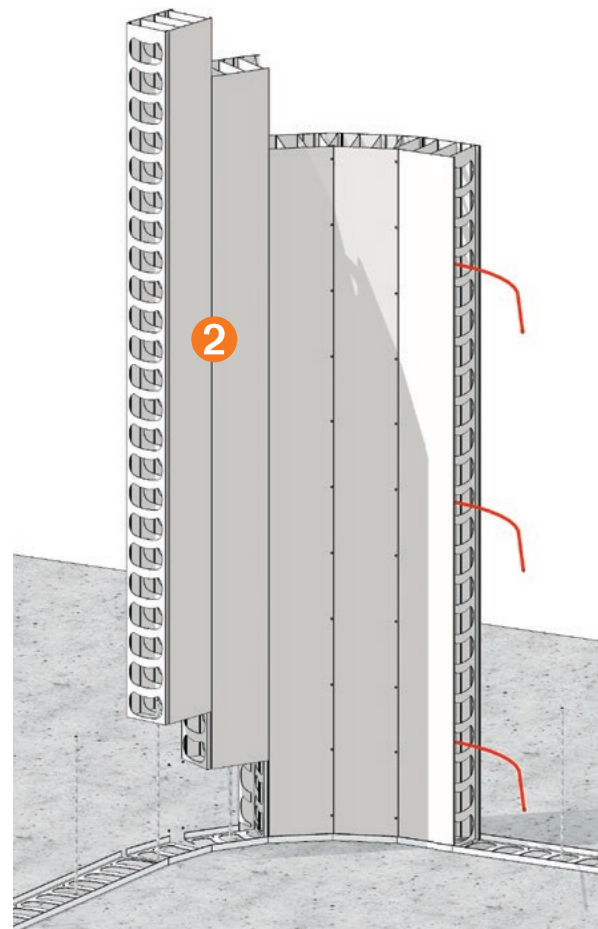

### Alternative Installation

On long curves and tight radius curves where it not possible to insert one long length of reinforcing bar, the bar can be installed in shorter lengths as the panels are being installed.

At junctions with straight walls and where more than one length of reinforcing is being used in curved wall sections, it is important to ensure appropriate lapping of the bars is being achieved, in accordance with Project Engineer's specifications.



## Stairway Landing Construction

### Stairs

**WARNING:** Where rediwall® panels are to be engaged with a landing or stairs, care is to be taken when creating openings in the rediwall® panel face to ensure that the web inside is not damaged causing the panels to be weakened.

Additional bracing support should be provided as per details in the Bracing section of this guide

**1** Engagement of the wall and adjoining structure can be achieved by cutting holes in the rediwall® face to install reinforcing bars. Use a hole saw as per Structural Engineer's details (100mm maximum diameter).

**2** Insert the required reinforcement steel as per the Structural Engineer's details.

**NOTE:** Formwork and bracing for stairs and landings is the responsibility of the site builder and engineer. Additional bracing may be required where suspended slab is tied in.

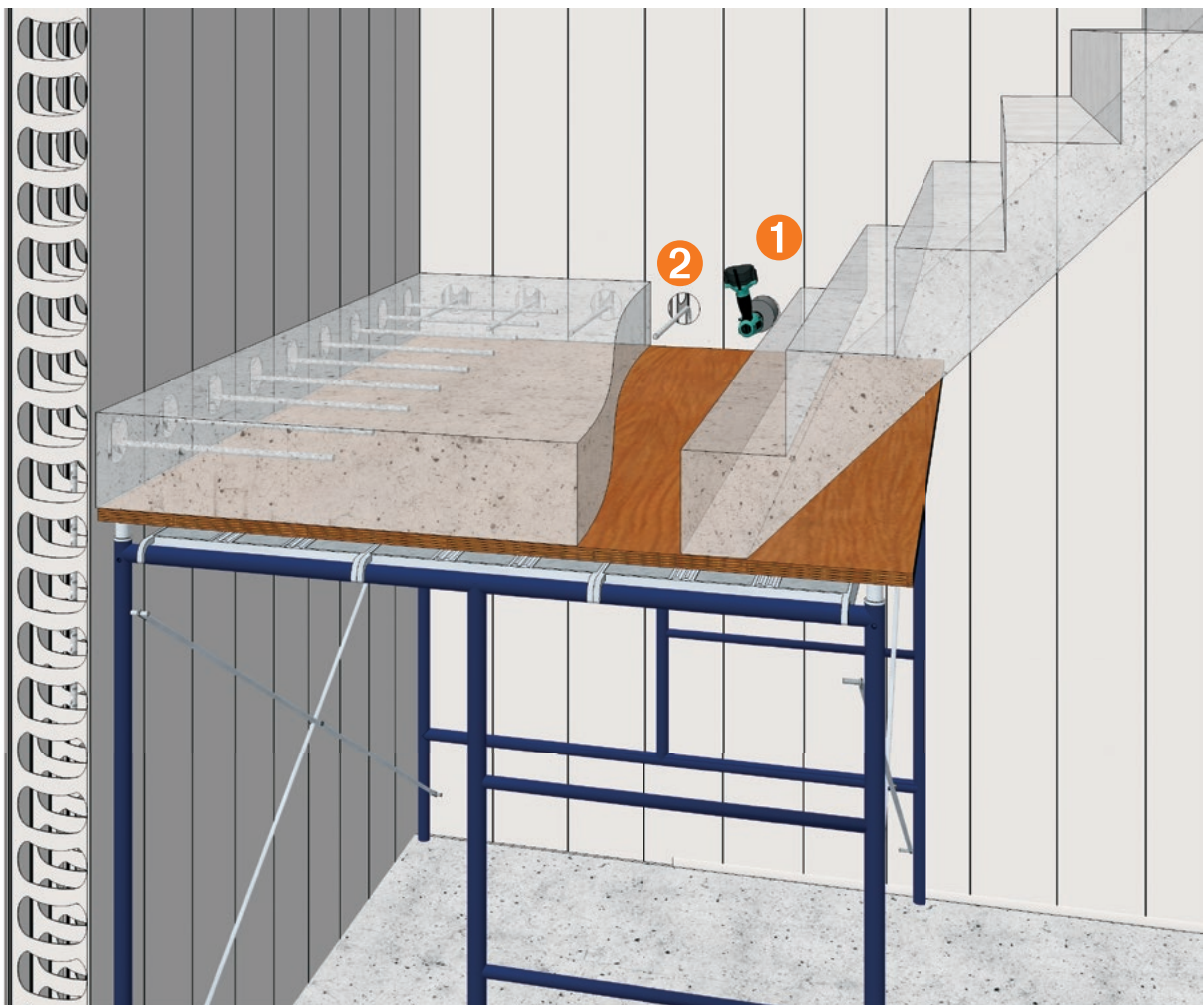

## Retention Tank Construction & Tanking

All waterproofing details are to be completed by the Project Builder and Waterproofing Contractor, in conjunction with the project engineer's details. When filled with concrete, rediwall® is a water resistant wall system. However specific areas requiring waterproofing details include horizontal concrete cold joints, and where water can track down along panel joints.

Any required waterproofing products must be installed strictly in accordance with the particular manufacturer's instructions.

**1** Determine the line of the rediwall® panels on the slab and install PVC floor track with centre cut out to accommodate waterstop. Mechanically fix the angle to the slab at 450mm centres.

**2** Install Waterstop to manufacturer's instructions, maintaining a continuous seal. Refer to the project building designer for details on Waterstop performance and installation requirements. Ensure that the water stop remains unobstructed through the rediwall® profiles and that it is not cut by the internal webs.

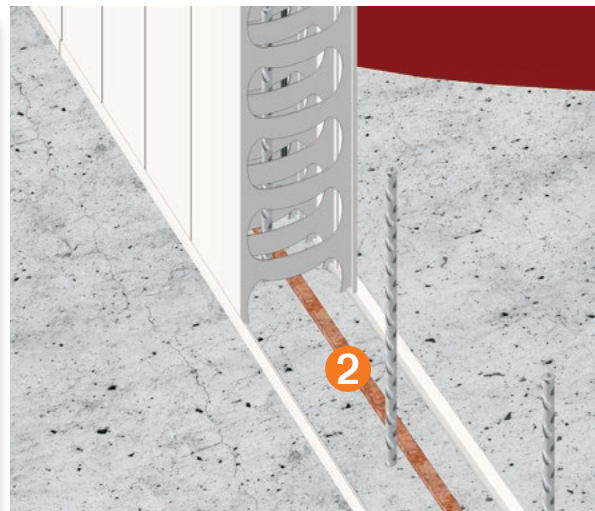

**3** Install the remaining rediwall® panels as per the standard installation method. Complete the tank with the required steel reinforcing as per Engineer's details.

**4** Core fill with concrete following the AFS recommended guidelines.

**5** A waterproof tanking finish is required. Apply tanking (supplied by others) as per the Engineer's details.

Note: The structure must be fully braced on both faces before concrete filling. Refer to the Bracing section for details.

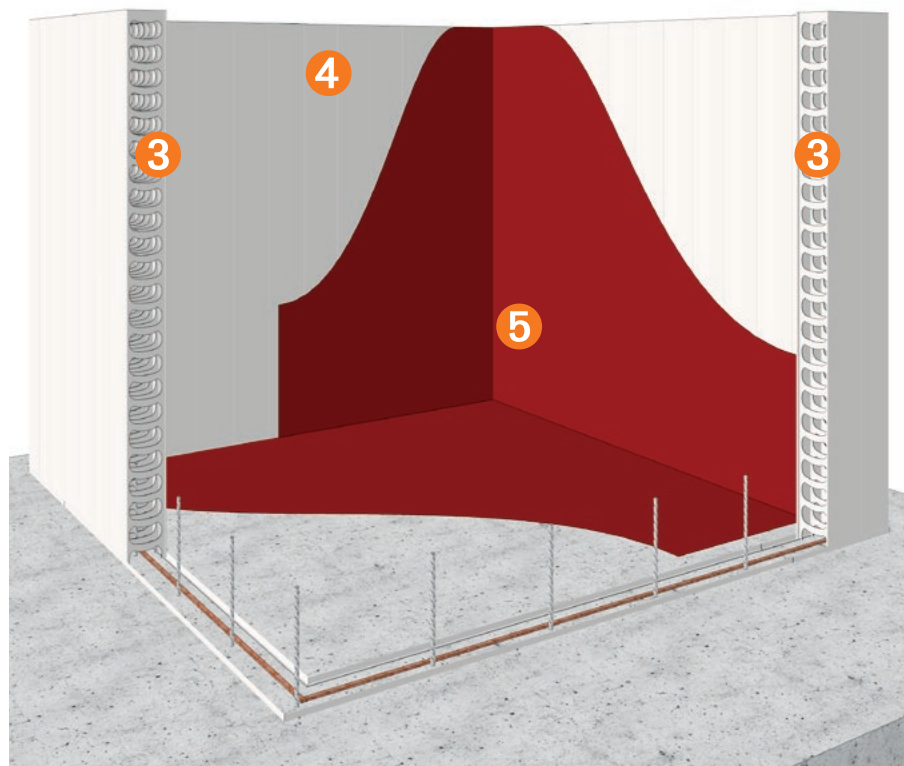

## Lift Pit

All waterproofing details are to be completed by the Project Builder and Waterproofing Contractor in conjunction with the project engineer's details. When filled with concrete, rediwall® is a water resistant wall system. However specific areas requiring waterproofing details include horizontal concrete cold joints, and where water can track down along panel joints. Any required waterproofing products must be installed strictly in accordance with the particular manufacturer's instructions.

**1** A waterproof tanking finish is required. Apply tanking

(supplied by others) as per the Engineer's details.

**2** Determine the line of the rediwall® panels on the slab and install PVC floor track with centre cut out to accommodate waterstop. Mechanically fix the angle to the slab at 500 – 600mm centres.

**3** Install Waterstop to manufacturer's instructions, maintaining a continuous seal. Refer to the project building designer for details on Waterstop performance and installation requirements. Ensure that the water stop remains unobstructed through the rediwall®

profiles and that it is not cut by the internal webs.

**4** Install the remaining rediwall® panels as per the standard installation method. Core fill with concrete following the AFS recommended guidelines.

**5** Complete the waterproof tanking as required (supplied by others) as per the Engineer's details.

Note: The structure must be fully braced on both faces before concrete filling. Refer to the Bracing section for details.

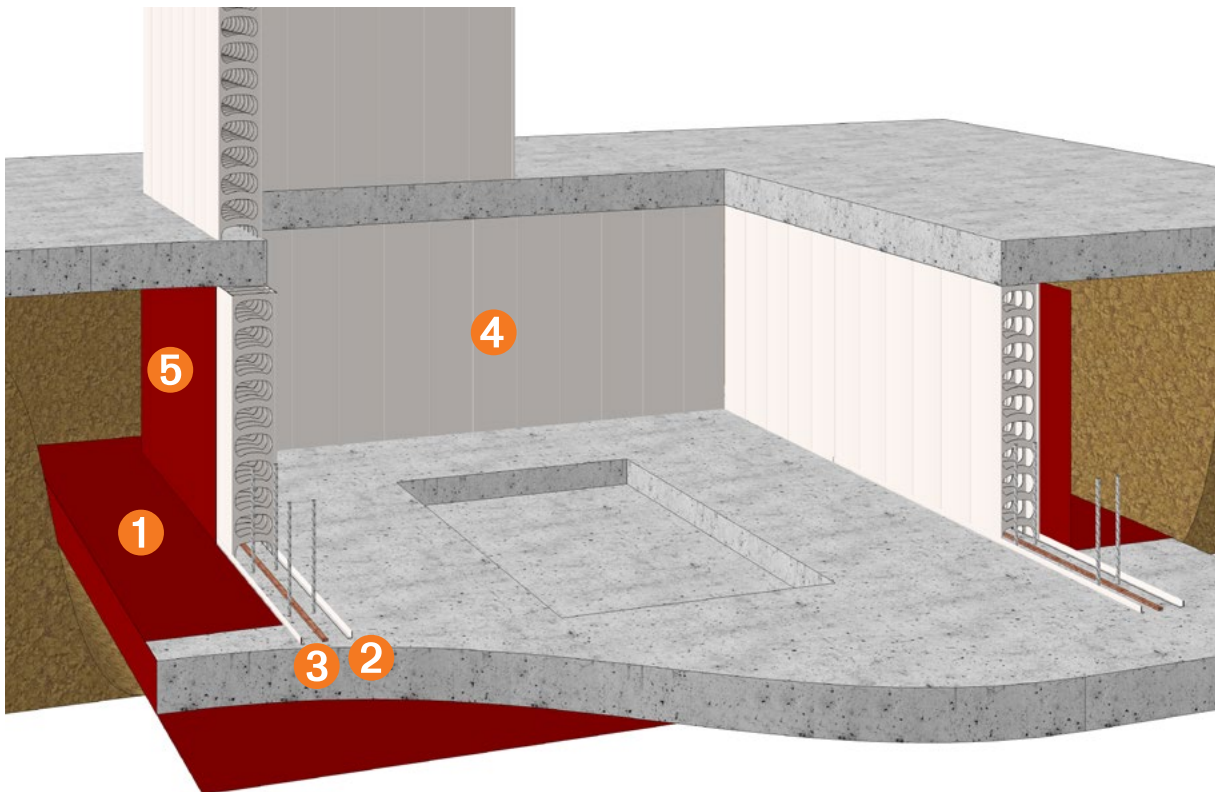

## Installation of Services

### Services Within Walls

Placement of electrical and data services within the afs rediwall® panel must take place between installation of wall panels and prior to concrete core filling. AFS does not recommend placement of high pressure services such as water or gas lines inside the wall panels.

Consideration should be made for the impact to acoustic performance of the wall due to service cast ins.

**1** Cut a hole at the required location for the service box.

**2** Insert the pre assembled conduit and service box.

**3** Screw fix the service box in place using a plaster bracket or similar. A screw is to be placed through the conduit to ensure that it does not dislodge from the wall box.

Note: Ensure service box locations do not interfere with the reinforcement, consult with the project engineer.

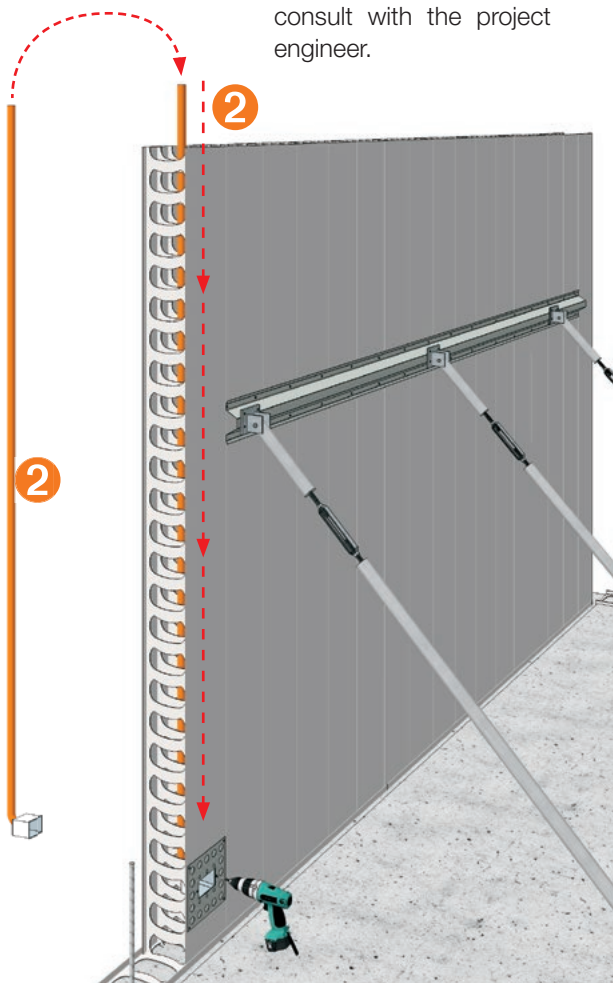

## Penetrations

### Non Fire Rated Service Penetrations

Penetrations for services and mechanical requirements may be cut on-site prior to core filling.

Alternatively, services penetrations may be cut/core drilled after core filling.

Refer to project specifications for details.

#### Rectangular Openings

- 1** Neatly cut out the required section from the assembled rediwall® panels.
- 2** Install End Cap to the reveals of the opening, and screw fix at 150mm centres on each side of the wall.

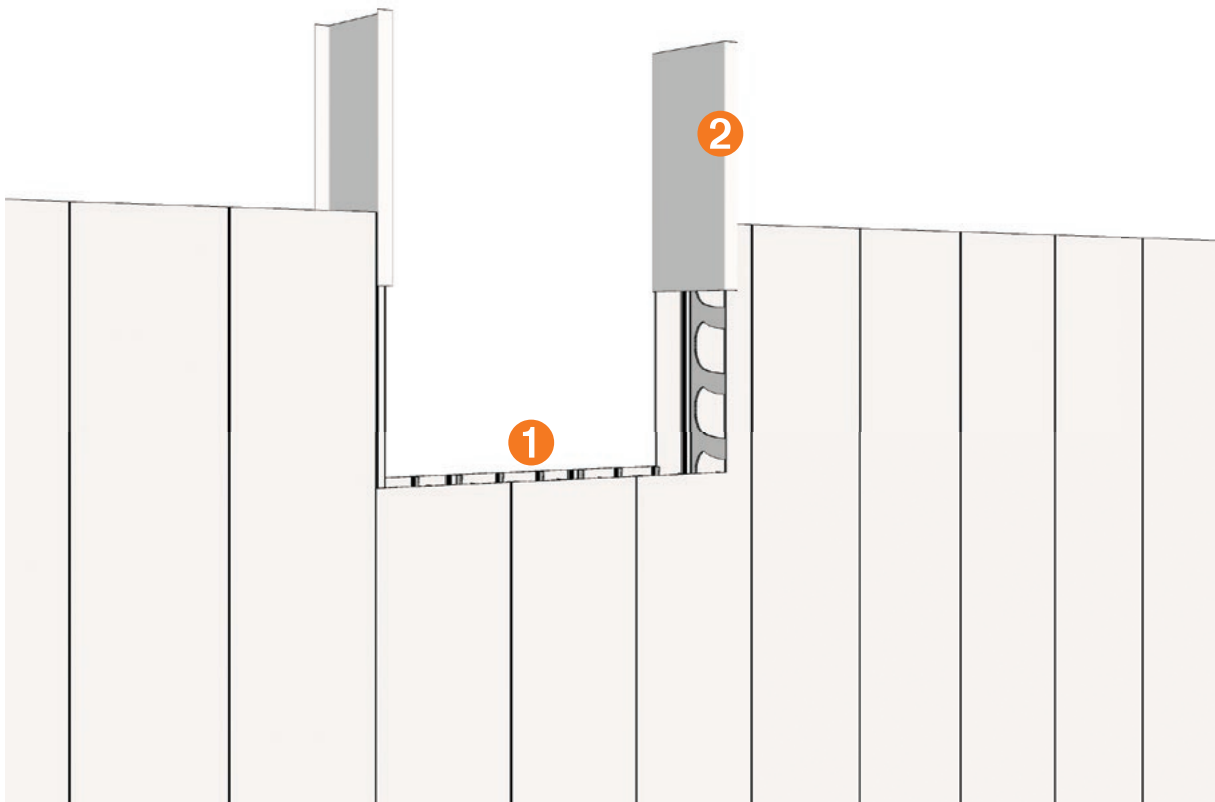

## Fire Rated Service Penetrations

Installation of a fire rated service penetrations into rediwall® can be performed without the removal of the PVC facing beyond the extent of the penetration opening. The installation of fire collars, or use of fire rated sealants, or fire dampers or brick infills can be used. AFS Rediwall® has been fire tested and assessed by CSIRO to AS1530.4 with various service penetration types through the rediwall® walls and shown to achieve FRL's up to:

- Cable tray: FRL –/120/120
- PVC piping, –/120/120
- Electrical cables (single or bundled): FRL –/120/120
- Copper and metal piping: FRL –/120/120
- Clay brick infill: FRL –/120/120
- Fire damper: FRL –/120/– (integrity)

For details of the above service penetration arrangements, installation and compliance requirements to CSIRO AS1530.4 testing of assessment , Refer to Volume 1 – Design, Performance and Compliance Guide service penetrations, as well as compatible fire protection system manufacturer's specification and installation requirements.

# Rediwall® Temporary Construction Bracing

## Introduction

Rediwall® requires temporary bracing for lateral stability during installation and core filling. The temporary bracing must withstand wind and other temporary construction loads that may occur during erection of the components, during placement of the concrete and until installation of the permanent floor and/or roof members that provide a lateral load resisting diaphragm.

The bracing requirements for rediwall® are to be determined based on the wall thickness, the wall height, the wall layout, the presence of permanent or temporary framing (girts, columns, roof, etc.), and the wall erection method, which is either by installing off a formwork deck or from scaffolding, or off slab or footing.

Also, the wall bracing scheme and technique depend on the specific site climatic conditions, soil and foundation conditions, material availability, location wind loads, BCA and site specific requirements.

It is highly recommended that the Project Engineer or Contractor be contacted to perform the bracing calculations and drawings based on the specific site conditions and wall layouts.

AFS has certified standard bracing available for use, please refer to Volume 1 – "Design Performance & Compliance Guide" temporary works section for more details of the AFS standard bracing system and certification. Alternative details can be prepared by an Engineer or Contractor.

The wind loadings are to be calculated in accordance with relevant applicable Building Codes, and with the appropriate reduction factor for temporary bracing.

The rediwall® components provide permanent formwork for both faces of a wall and include integral internal webs to hold the two faces together during concrete placement.

Rediwall® requires a horizontal whaler between braces to ensure straightness of rediwall® elements.

Bracing is also required for areas that are subject to unbalanced hydrostatic pressure during concrete placement. Typically, these areas include openings, corners, T-junctions and wall ends.

The bracing should be re-checked immediately prior to the placement of concrete to ensure that all members are properly installed and that the rediwall® components are correctly located, aligned plumbed and braced.

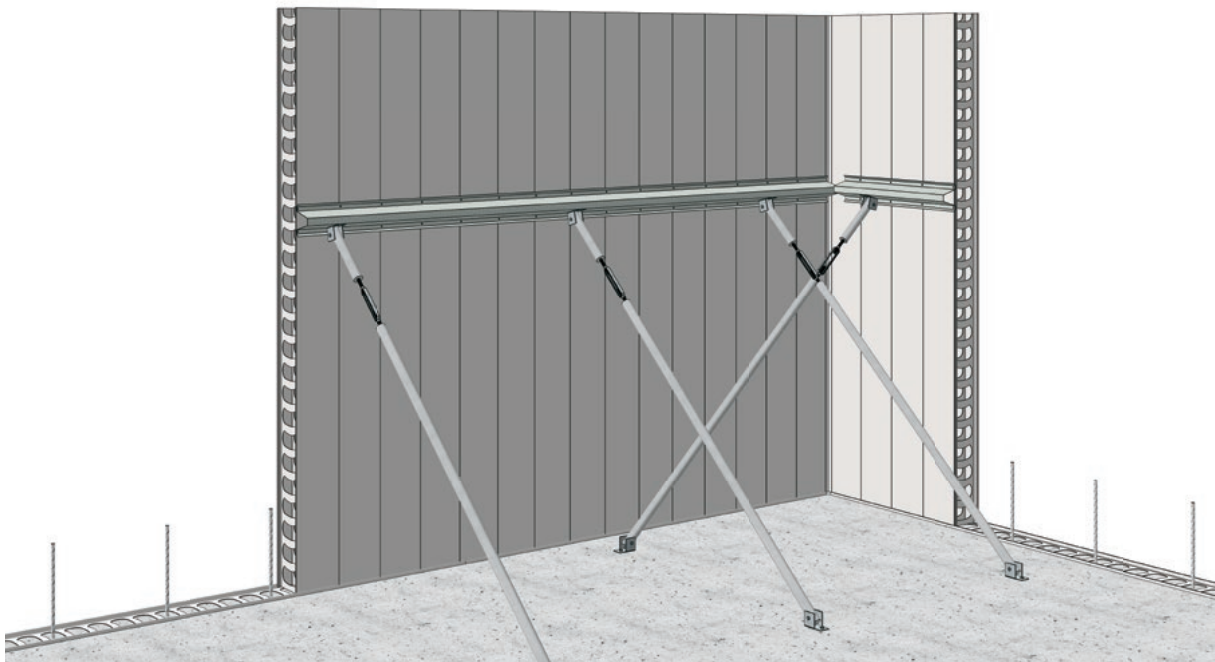

## Bracing of Walls to 3.3m Height

All rediwall® walls require horizontal bracing for lateral support prior to concrete pouring. This can be by attachment to a completed formwork deck or bracing struts secured to the panels and anchored to the slab.

For walls up to 3.3m height a continuous horizontal bracing member is required on one or both sides. The AFS standard bracing system has been designed and certified to cater for this configuration.

Site conditions such as high wind areas and work safety should be considered when bracing. Consult the Project Engineer for specific bracing requirements.

**1** AFS recommends that the horizontal brace Top Hat be attached in the top one third of the panel height or at the top of the panels. As a minimum, the bracing Top Hats should be screw fixed to each rediwall® panel with two screws at the panel joint location.

**2** The horizontal brace plate is to be connected to angled adjustable braces that are anchored to the slab or deadmen 1100mm apart. For walls over 3.3m contact the project manager or site engineer for details on bracing requirements.

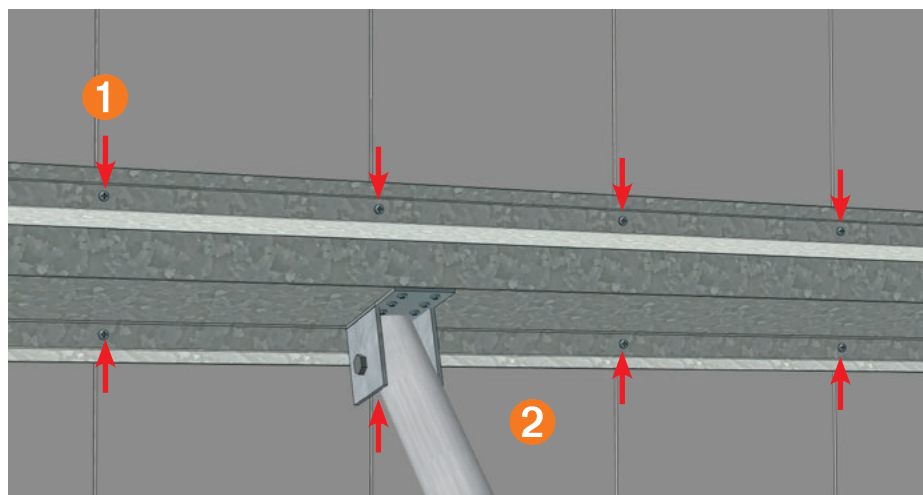
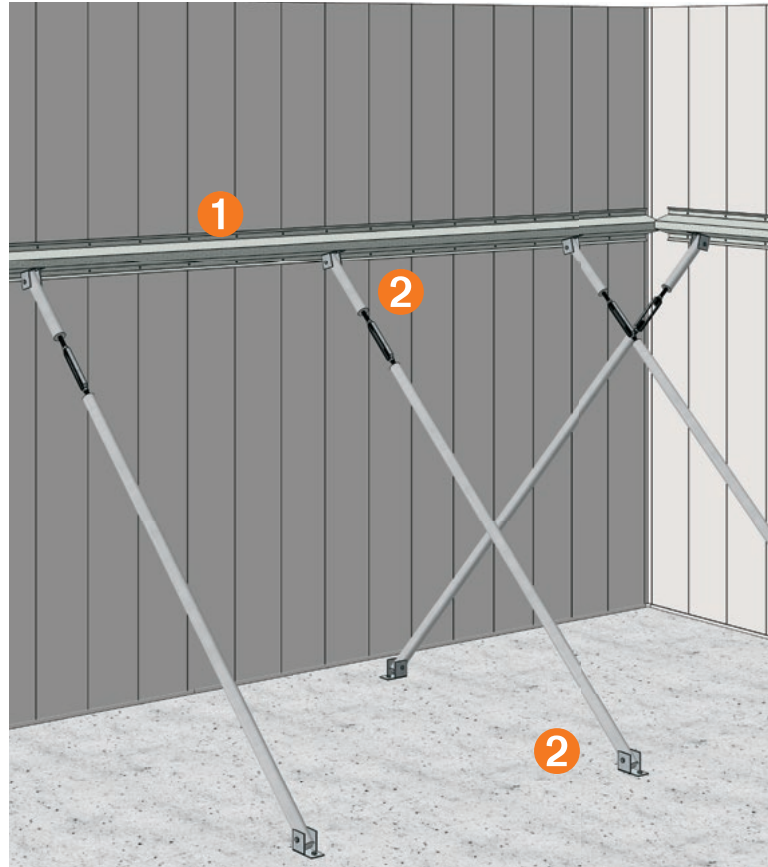



## Bracing from Formwork Deck

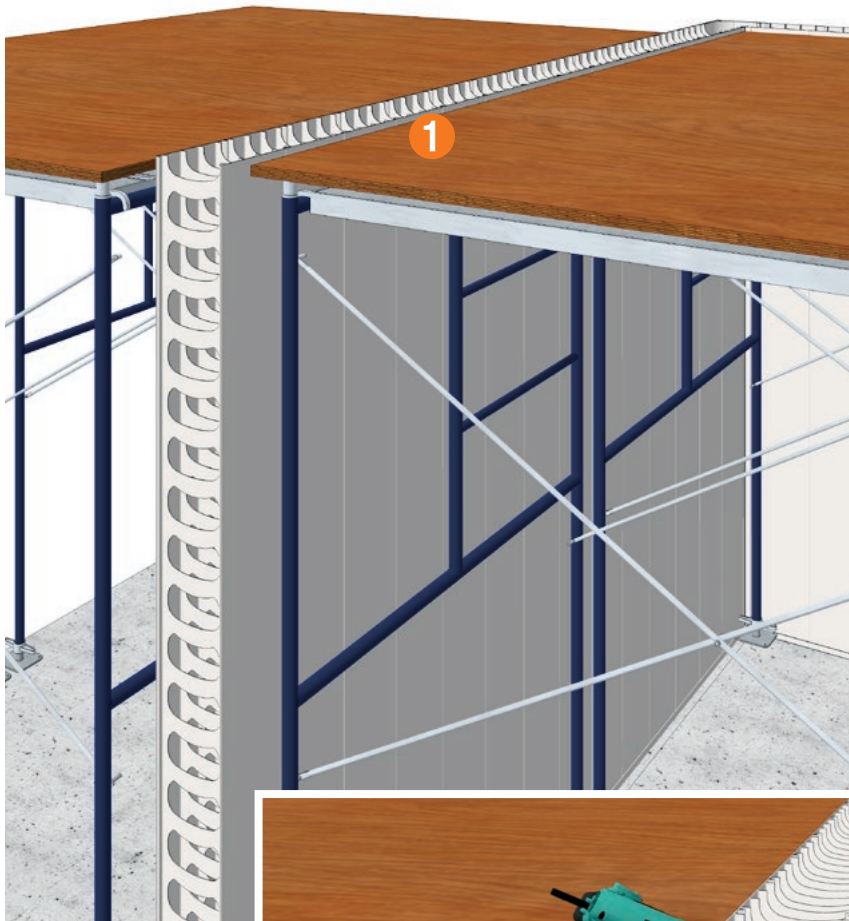

Rediwall® systems 3.3m or less in height that are being installed in conjunction with a formwork deck can be braced by being fixed directly into the form ply deck.

**1** Formwork decking should be constructed and independently braced before erection of the rediwall® panels. Ensure deck is secure and at the appropriate height.

**2** Fix rediwall® panels to the formwork deck using appropriate fixings at each panel.

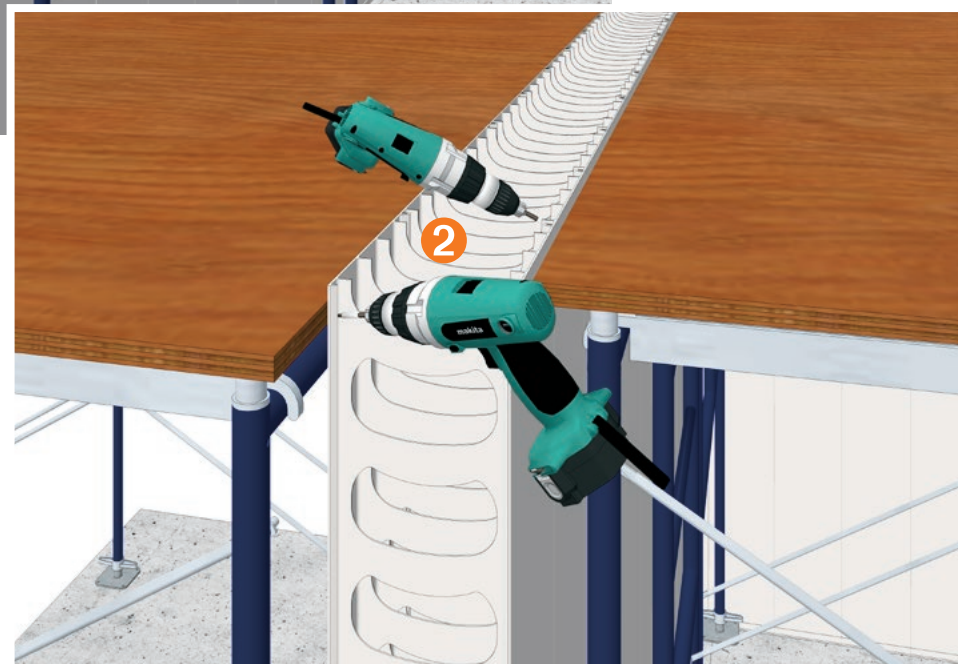

## Bracing End Caps

The ends of walls, wall corners and wall intersections will tend to move laterally as the concrete is cast. AFS recommends full height bracing to prevent bulging during concrete placement.

- 1** The vertical bracing timber shall be the full height of the wall, and is to be pressed firmly against the wall end cap.
- 2** The vertical bracing is to be anchored to the wall panels using hoop iron straps. The straps shall be located at a distance of 300mm maximum from the top and bottom of wall. The spacing between the straps shall not exceed 1500mm. Screw fix hoop iron straps to at least 3 panels at the joint location on both sides of the wall.

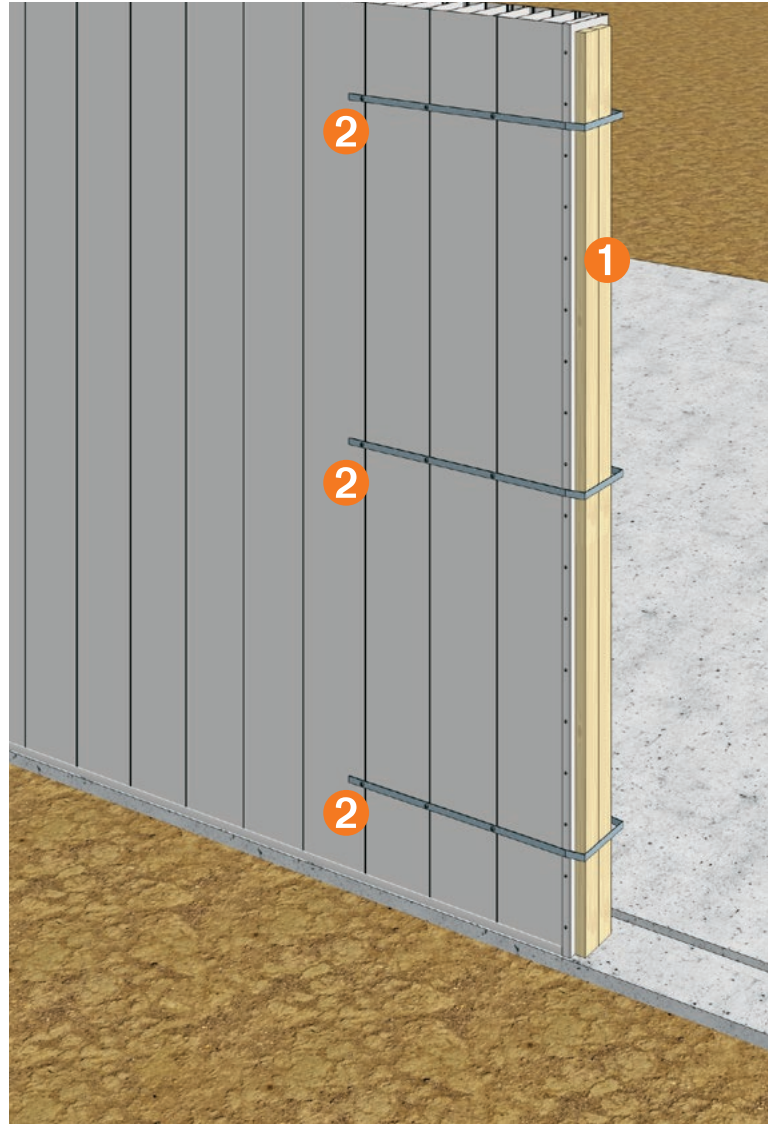

## Bracing of T-Junctions

Where a T-junction is made, the main wall shall be adequately propped on the opposite side and local to the T-junction. This bracing is required to contain any lateral forces when this section of the wall is filled with concrete and to avoid dislodgement. For a short T-wall or nib, the end of this short T-wall shall also be adequately propped to stop potential bulging of T-junctions.

- 1 The external vertical bracing timber shall be the full height of the wall, and is to be pressed firmly against the wall opposite the T-junction. A backing plate of 19mm ply should be used with a width of a least 100mm overlap on either side of the panel junction width. For example RW200C requires an overall width of  $100+200+100=400\text{mm}$

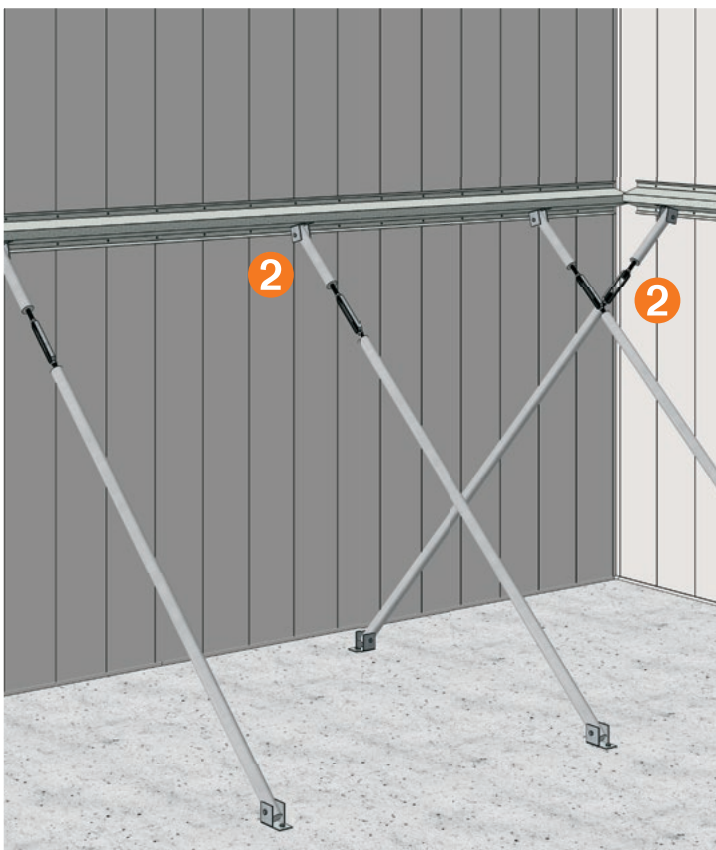
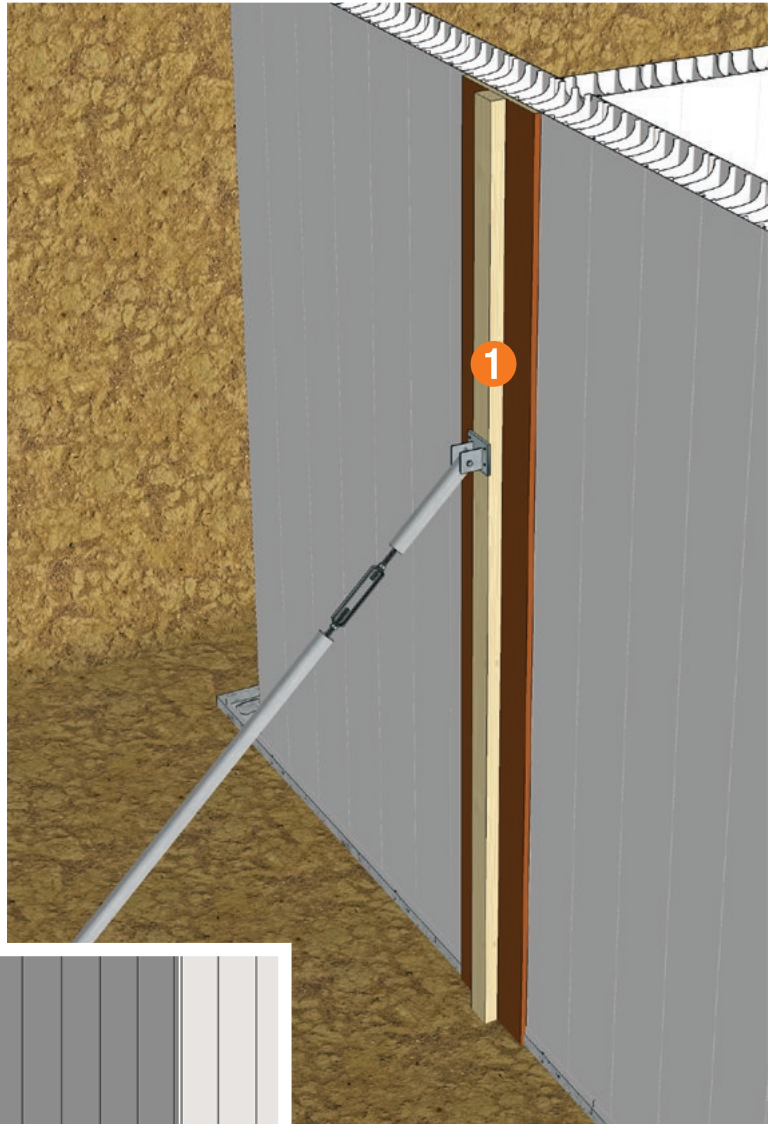

- 2 The internal bracing of the T-junction is to be in accordance with the standard bracing detail in this manual. All wall junctions must be braced.

## Bracing of Rediwall® Edge Form

- 1 Contact AFS for information on edge form bracing. Alternatively contact the consulting project engineer, contract formworker or principal building contractor for details.

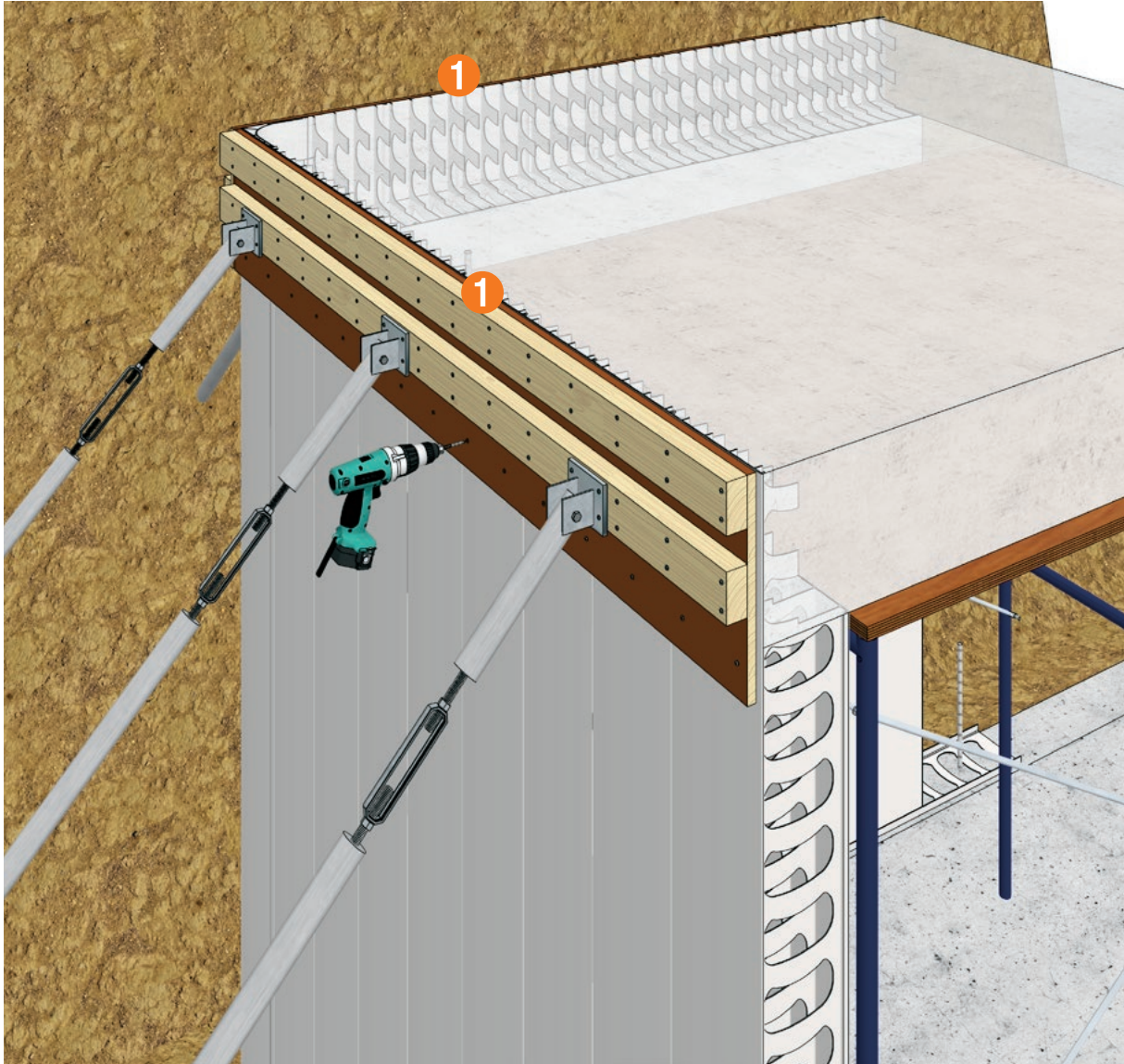

## Bracing of Window Openings

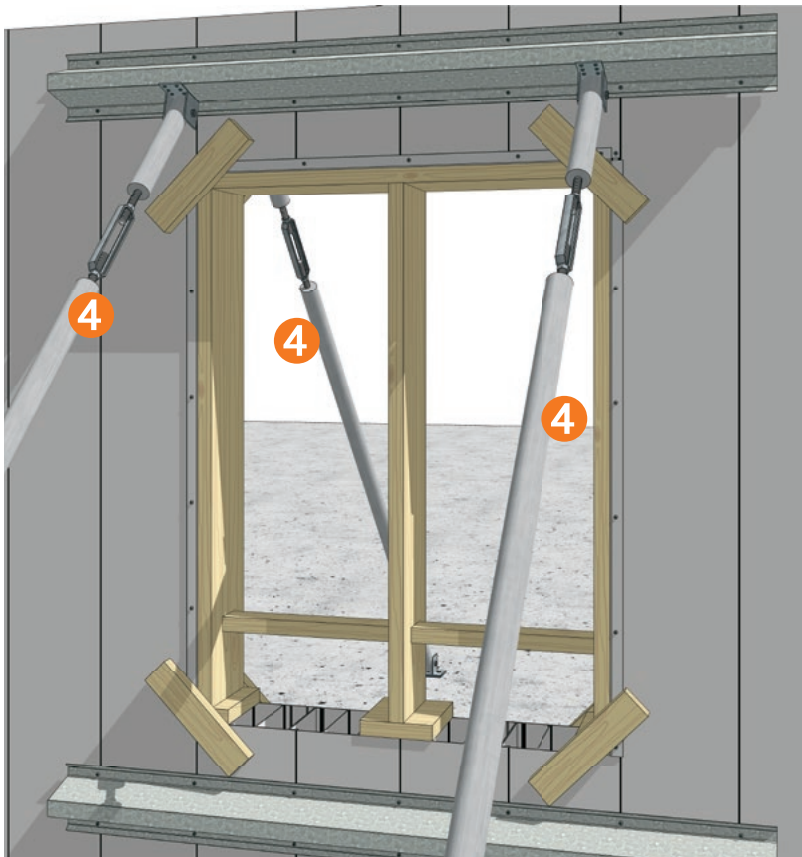
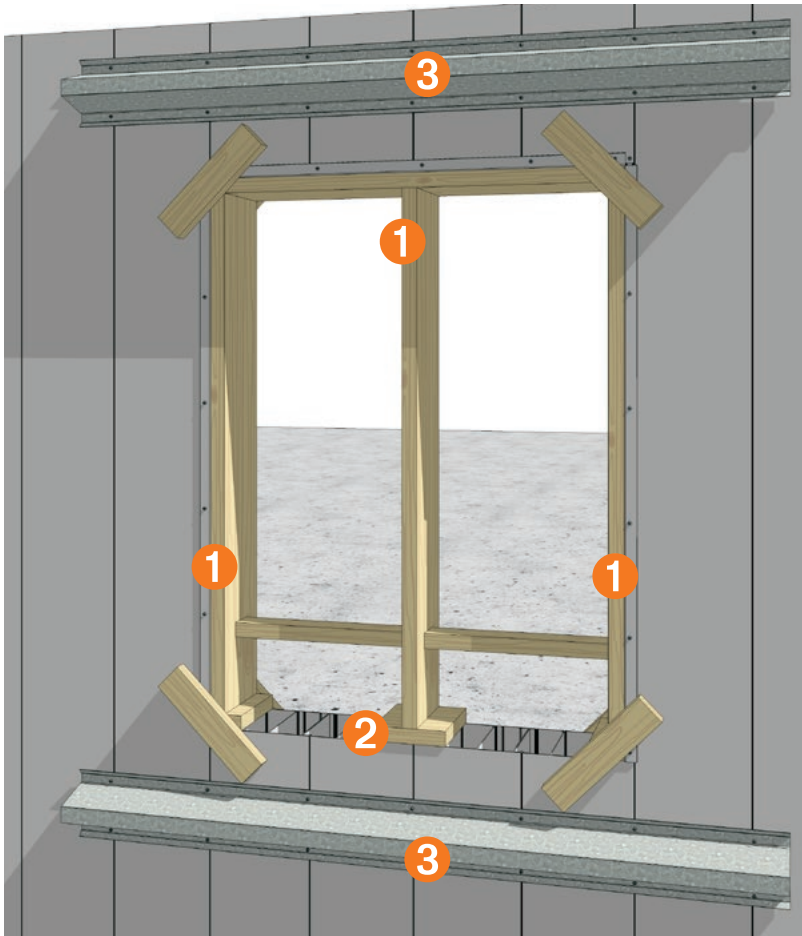

Refer to construction details for sill and lintel panel installation.

Openings can be distorted during the core filling process. AFS recommends that all openings be fully braced prior to core filling.

**1** Continuous timber caps are required at the top and sides of all openings to maintain a flat surface and to prevent the face of the opening from bowing due to the vertical and horizontal concrete pressure. Caps are typically formed using conventional timber framing. The cap may be connected to the rediwall® components to prevent separation of the wall panel from the cap.

**2** All timber caps require vertical and horizontal struts to support the head and jambs respectively, to keep the opening square, to resist the concrete pressure and weight and to maintain the correct opening dimensions.

**3** The head and sill of openings more than 1.2m wide require a whaling plate on both faces of the wall to maintain a flat plane across the opening.

**4** The whaling plate is connected to angled braces (at 1100mm maximum horizontal spacings) anchored to deadmen or the floor slab, in order to hold the opening plumb.

## Bracing of Doorway Openings

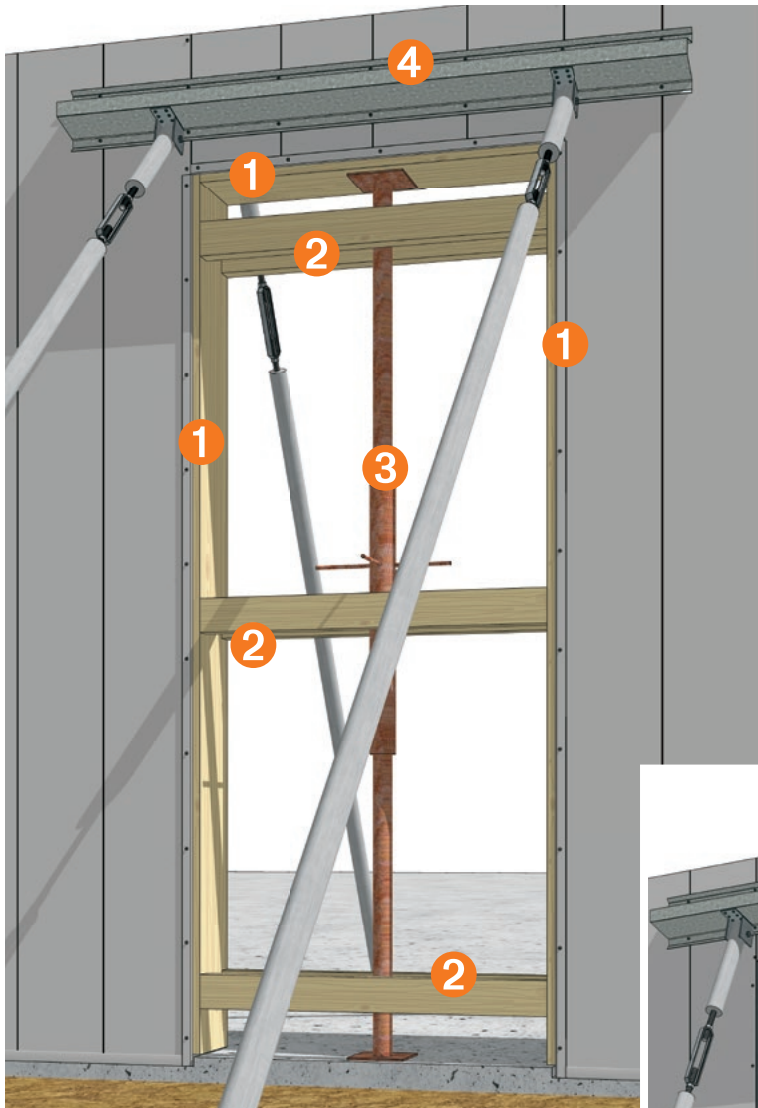

Refer to construction details for sill and lintel panel installation.

Openings can be distorted during the core filling process. AFS recommends that all opening to be fully braced prior to core filling.

### Bracing – Formed Doorways

- 1 Brace sides and head of the opening to the full width of the wall with timber caps.
- 2 Install two parallel horizontal braces to the outer edges of the caps at the top, bottom and middle of the opening.
- 3 Install vertical shoring as required, (adjustable props may be used).
- 4 A whaling plate on both faces of the wall is connected to angled braces (at 1100mm maximum horizontal spacings) anchored to deadmen or the floor slab in order to hold the opening plumb.

### Bracing – Metal Framed Doorways

Built in metal door frames must be installed accurately and squared/plumbed correctly. Refer to construction details earlier in this manual.

They also require sufficient bracing to prevent distortion during concrete filling, which can be achieved by installing metal turnbuckle braces or timber bracing.

- 1 Brace sides of the opening to the full width of the wall with timber caps.
- 2 Install two parallel horizontal struts to the outer edges of the caps at the top, bottom and middle of the opening.
- 3 The bottom of the metal door must also be braced to prevent the door from skewing. Run a timber chocks along each side of the foot of the door frame and fix to the concrete slab.
- 4 A whaling plate on both faces of the wall is connected to angled braces (at 1100mm maximum horizontal spacings) anchored to deadmen or the floor slab in order to hold the opening plumb.

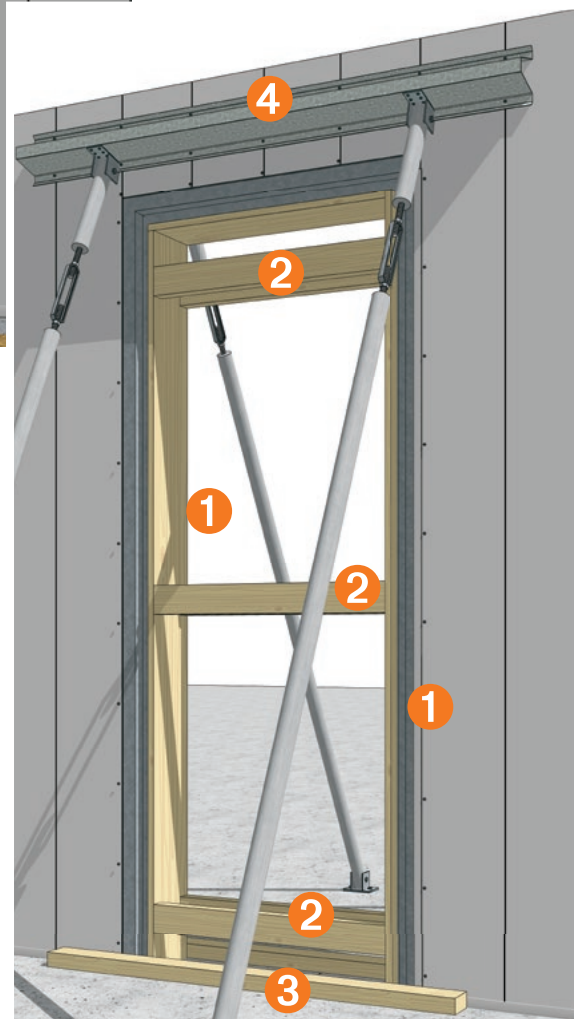

## Bracing of Wide Radius Curved Walls

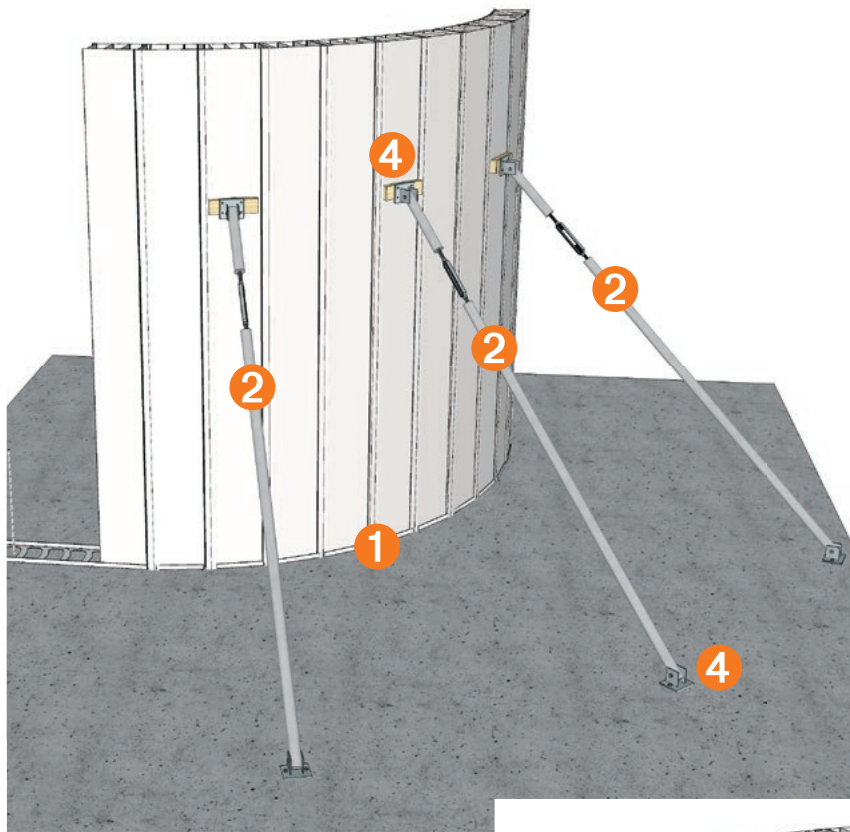

- 1** Ensure that all panels have been screw fixed to the floor track, and that all H-Joiners have been screw fixed to their adjacent panels.
- 2** Bracing must be used on the outer radius of a curved wall. It is recommended that at a minimum, every third wall section be braced.
- 3** For the internal radius of a curved wall use the same bracing technique as for a standard wall. It is recommended that at a minimum, every third wall panel be braced.
- 4** Screw fix the brace to the horizontal support and then securely fix the brace to the slab or deadman.

## Bracing of Tight Radius Curved Walls (not shown here)

Ensure that all panels are screw fixed to the floor track and that all H-Joiners have been screw fixed to their adjacent panels.

Bracing must be used on the outer radius of a curved wall. Each infill spacer must be braced for the full height using suitable formwork timbers erected vertically against the infill spacer and braced diagonally back to the slab or deadman.

For the internal radius of a curved wall use the same bracing technique as for a standard wall. It is recommended that at a minimum, every third wall panel be braced.

Screw fix the brace to the horizontal timber support and then securely fix the brace to the slab or deadman.

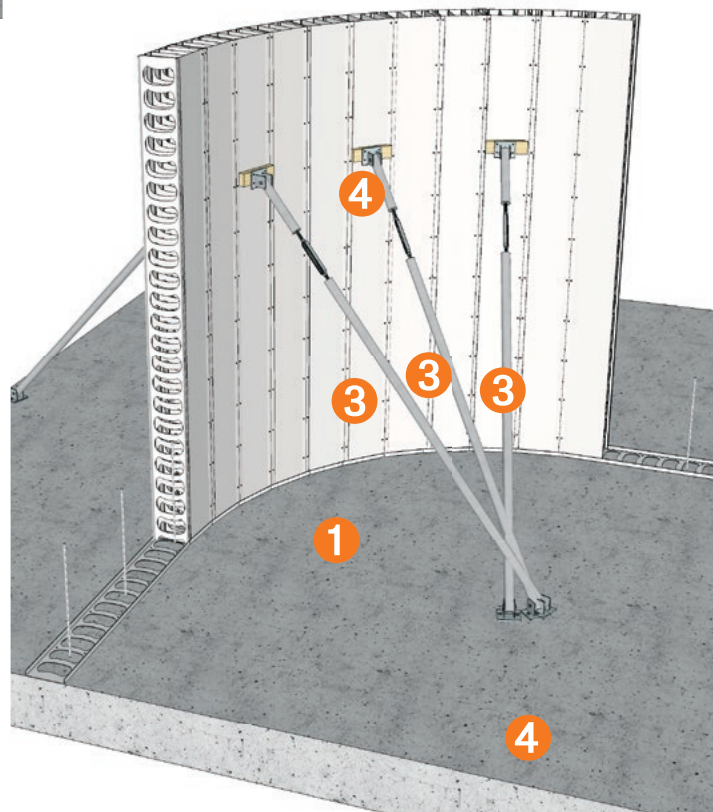

# Core Filling of Walls

## Introduction

AFS Rediwall® cannot be filled with concrete using traditional concrete mixes. The concrete mix and concrete placement technique is critical to the successful outcome of filling rediwall®.

AFS has carried out tests which achieved desired compaction and dense, homogeneous coverage of afs rediwall®.

This guide sets out the methods used by AFS to achieve suitable compaction.

The contractor or installer is responsible for achieving compaction and dense, homogeneous coverage of the concrete mix in rediwall®.

## Concrete Pour Limitations

When panel installation is complete and all appropriate bracing and checks completed, the walls can be filled with concrete.

The quantity of concrete that can be poured in a day must be assessed and determined in consideration of the following factors:

- Ease of access
- Number of passes (or lifts) that are required
- Concrete gelling time between passes
- Consideration of wet weather

For wet weather, on-site conditions should be assessed and the concrete pour either be delayed or be undertaken with caution, applying measures to suit the given conditions.

## Additional Equipment Required for Concrete Pour

Prior to commencing a pour, ensure that a concrete vibrator with flexible shaft and 38mm head is ready for use, and that multiple shovels, trowels, screw guns, screws and at least one wheelbarrow are readily available.

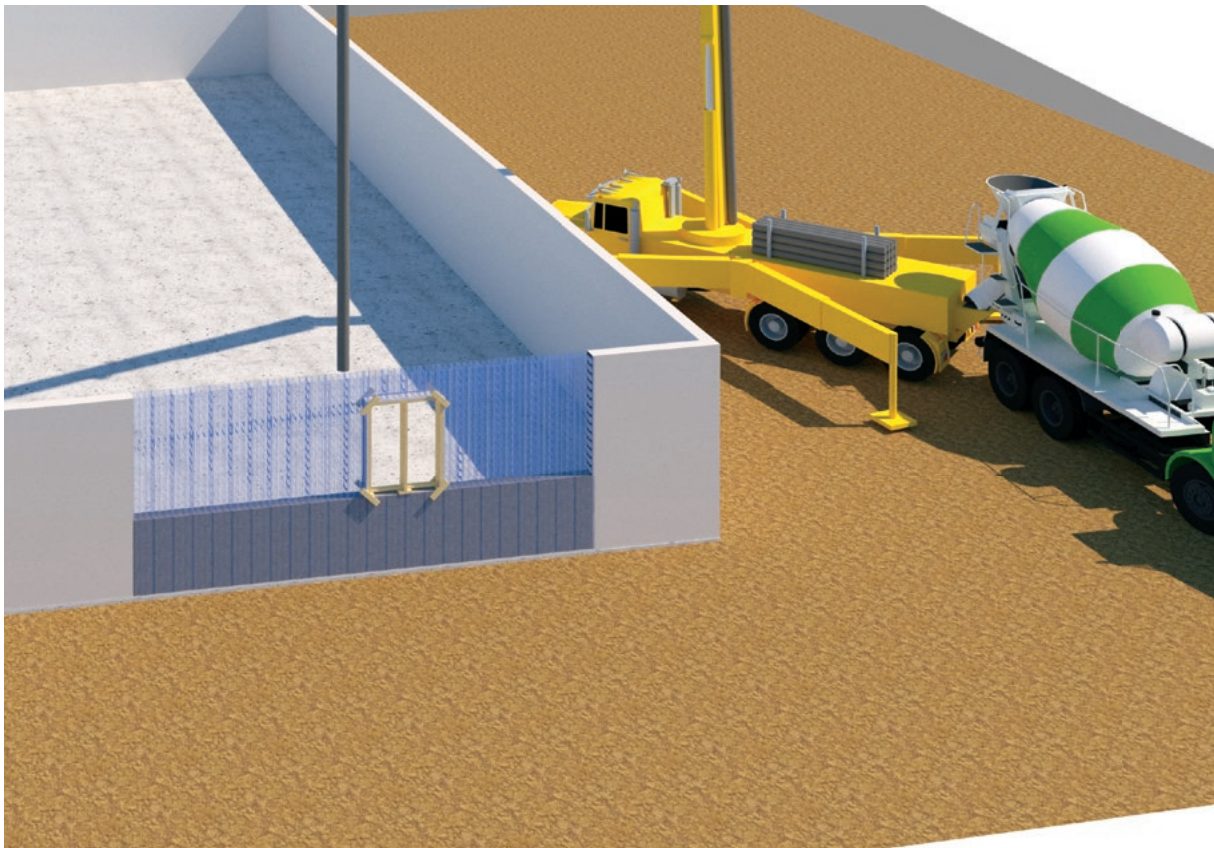



## Number of Concrete Passes/Lifts Required

Walls up to 3 metres high can be filled in 2 passes/lifts with the first pass being to a maximum height of 1.2 – 1.5m. Walls from 3 – 6m should be filled in 3 – 4 passes with the first and second pass being to a maximum height of 1m each.

Allow at least 45minutes between passes for concrete to gel.

Higher concrete strength mixes will gel faster than low strength mix designs. These guidelines will vary according to site conditions, with the requirement of extra passes and extra gelling time in wet/cold weather. In cases of extreme weather the concrete pour should be postponed.

## Concrete Mix Design

The concrete supplier is responsible for providing a mix design that is suitable for filling rediwall®.

The concrete core fill mix must be designed with enhanced flow characteristics. Such concrete is available from most of the major concrete suppliers.

AFS trials and experience have shown that a concrete mix that is designed such that segregation and blowouts are prevented whilst achieving the required level of compaction will have the following basic characteristics:

- $f'c = 25$  to 65 MPa (to be as specified by the project structural engineer).
- 7-10mm maximum aggregate.
- A long line, or pumpable wall mix is normally used to fill rediwall®. Block fill mix is not recommended.
- Design slump of 180mm.

## Concrete Usage

Rediwall® Panel	RW110C	RW156C	RW200C	RW256S	RW275S	RW300S
Per Cubic Metre of Concrete	Square Metres of Wall Area					
	9.7m <sup>2</sup>	6.7m <sup>2</sup>	5.2m <sup>2</sup>	4.0m <sup>2</sup>	3.7m <sup>2</sup>	3.4m <sup>2</sup>
Per Square Metre of Wall Area	Cubic Metres of Concrete					
	0.103m <sup>3</sup>	0.149m <sup>3</sup>	0.193m <sup>3</sup>	0.247m <sup>3</sup>	0.267m <sup>3</sup>	0.291m <sup>3</sup>

## Rediwall® Concrete Mix Design Guide

	AFS Rediwall® Mixes (Refer to Structural Engineer for Mix specification)				
Strength $f'c$ (MPa)	S25	S32	S40	S50	S65
Target Installation Slump	180±20	180±20	180±20	180±20	180±20
Design Slump (mm)	180	180	180	180	180
Maximum W/C Ratio	0.7	0.6	0.45	0.4	0.35
Nominal Fine to Total Aggregate Percentage (%)	65	60	55	50	50
Maximum Aggregate Size (mm)	10	10	10	10	10
Maximum 56 Day Drying Shrinkage (µm)	1000	1000	1000	1000	1000
Recommended Admixtures	WRPAPN20 (WR) ex Grace, ADVA-142 (HWR) ex Grace, or equivalent				

Notes:

- For higher on-site temperature environments slump of the batching plant may be varied to suit these conditions.
- Site water is allowed to be used to reach desired installation slump however, the maximum W/C ratio must not be exceeded.
- Due to local raw material availability, characteristics will vary significantly, refer to Project Engineer for further details.
- The addition of all admixtures are typically dosed at the beginning of the batch.
- Concrete mix should have a typical 'Gel' time of 30-60min in accordance with the Gel Test detailed in this guide.

## Concrete Delivery & Placement

The concrete must be placed using a suitable concrete pump via a 50mm delivery hose. Never fill rediwall® using a kibble.

The average pump rate for core filling afs rediwall® is 12m<sup>3</sup> per hour. It is important to advise the concrete supply company of the required delivery turnaround time. (e.g. 1 x 5m<sup>3</sup> load every half hour, taking approximately 30mins to empty the truck).

Admixtures including plasticiser and flyash are used to increase the target slump to 180mm maximum for standard AFS pump mixes.

## Concrete 'Gel' Test

The concrete core filling of rediwall® is undertaken in passes, with concrete pours limited to 1500mm high per pass. A simple reinforcement test shall be undertaken to check that concrete in each pass has 'gelled' sufficiently before the subsequent pass (typically 45 minutes or more). The test steps are as follows:

- A. After the first pass of the concrete pour, lower an N12 or N16 reinforcement bar into the rediwall® cavity until the reinforcement contacts the wet concrete.
- B. Let the reinforcement bar fall under its own weight. If the reinforcement bar sinks 75 - 125mm into concrete and stops, it indicates that the concrete has 'gelled' sufficiently for the second pass of the concrete pour to commence.
- C. If the reinforcement bar does not stop and continues to go down into the wet concrete, the concrete is still too wet for commencement of the second pass of the concrete pour. Allow suitable time for the concrete to 'gel'. Then, conduct the test again to check and ensure that it meets the bar sink criteria as noted in Step 'B' before proceeding to the next pass of the concrete pour.
- D. Depending on wall height, the gel test shall be carried out for all subsequent passes of the concrete pour.

## Concrete Pour Procedure

### CORNERS

Start pouring the wall near the 'Corner'. Hold the hose directly over the panels, placing concrete to create a "concrete mound" to a maximum height of 1500mm in the corner. Continue pour "cascading" concrete away from the corner along the wall until the maximum pour height of 1500mm is reached.

If pouring from one corner to the next (Lift Shaft, etc), move the hose forward to the corner and work your way back to the middle of the wall, until the maximum pour height of 1500mm is reached.

**Note:** When using the afs rediwall® corner assembly the outer corner edge voids do not need to be concrete filled to maintain structural integrity of the corner section.

### T-SECTION

Start pouring the wall from the 'T-Section'. Hold the hose directly over the panels, placing concrete to create a "concrete mound" to a maximum height of 1500mm, then continue cascading the pour moving away from the T-Section until the maximum pour height of 1500mm is reached.

### END OF WALL.

Start pouring near the end of the wall. Hold the hose directly over the panels, placing concrete to create a "concrete mound" to a maximum height of 1500mm, then continue cascading the pour moving away from the end of the wall until the maximum pour height of 1500mm is reached.

### DOOR FRAMES

Start pouring the wall from the 'Door Frame'. Hold the hose directly over the panels, placing concrete to create a "concrete mound" against the frame to a maximum height of 1500mm, then continue cascading the pour moving away from the door frame along the wall until the maximum pour height of 1500mm is reached.

### WINDOWS AND HEADERS

At openings, such as windows or large mechanical penetrations, lower the hose under the formwork deck and ensure all sills are adequately filled. On the remaining lifts, core fill headers and lintels.

## Start Locations and Pour Lines

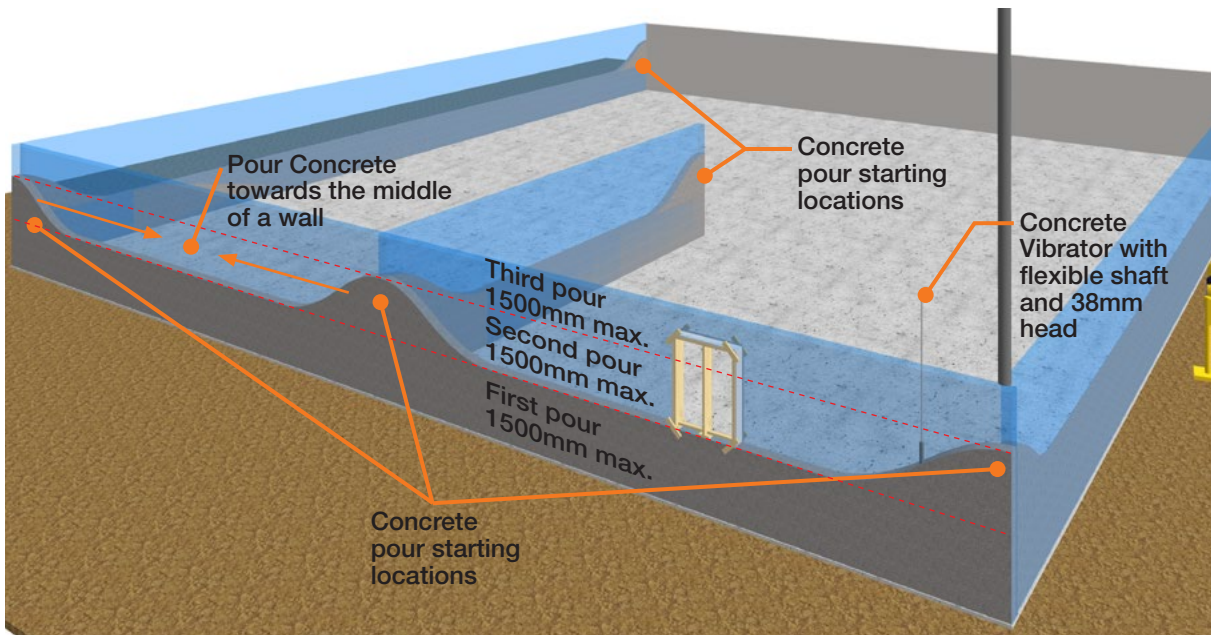

## Use of a concrete vibrator in AFS Rediwall®

For the vibration of concrete a concrete vibrator with flexible shaft and 38mm head is to be used. Place the vibrator at the bottom level of the pour and move up and out of the pour zone slowly over a period of 5-10 seconds, or no further air bubble develop of the surface of the concrete. Repeat every 300-400mm apart, in each completed pour (max 1500mm height).

Care should be taken when vibrating not to directly vibrate the reinforcing steel to ensure monolithic concrete wall.

The vibrator should not be held against the panel faces.



Battery operated vibrator

Petrol operated vibrator

## Finishing of Sills & Top of Wall

When the sills and tops of walls have been filled, they should be neatly trowel finished.

The top of the sill/wall is either:

1. Left set down slightly if a slab is to be poured over the top;
- OR
2. Trowelled off smooth to 5mm fall if it is the finished top of a wall or if it is to be the bearing edge for Delta-core or Ultra-floor to sit on.
- OR
3. If the top of wall is to be left exposed, an additional waterproof capping is to be added.
- OR
4. Trowelled off smooth to 5° fall if it is the finished top of a window sill.

## Placing of 'L' Bars at Top of Wall

Reinforcing 'L' bars may be required to be placed in the wet concrete at the top of the wall to tie the wall and future overhead floor slab together.

Reinforcing 'L' bars must be placed and temporarily held in-place until the concrete cures. Design, spacing and placement are to be confirmed by the Project Engineer.

## Concrete Clean-up

During the pour, some concrete splatter may occur on the slab below and down the face of the afs rediwall® panels.

All concrete splatter must be cleaned off before it cures.

Team members should follow the pour, brushing all splattered concrete off the slab and walls and if necessary, wiping the walls down with a wet sponge.

## Early Removal of Temporary Bracing

Temporary bracing is normally removed once the slab over is poured or the roof is attached. However, if due to site conditions or other circumstance, it is desirable to remove the temporary bracing earlier, approval must be obtained from the Project Engineer, especially in situations where the rediwall® is to become a retaining wall and will be back-filled against, or is to be loaded with a pre-cast slab system such as 'Delta-core.'

## Cleaning of Finished AFS Rediwall®

For cleaning of finished rediwall®, use high pressure water blasting, conducted in a similar way to brick cleaning. If required, a 10% acid or lemon concentrate can be added to the cleaning mix.

Patching of holes after removal of temporary bracing can be achieved by applying colour matched filler sealant or equivalent. Once dry, remove excess with sharp chisel or blade to achieve a flat surface.

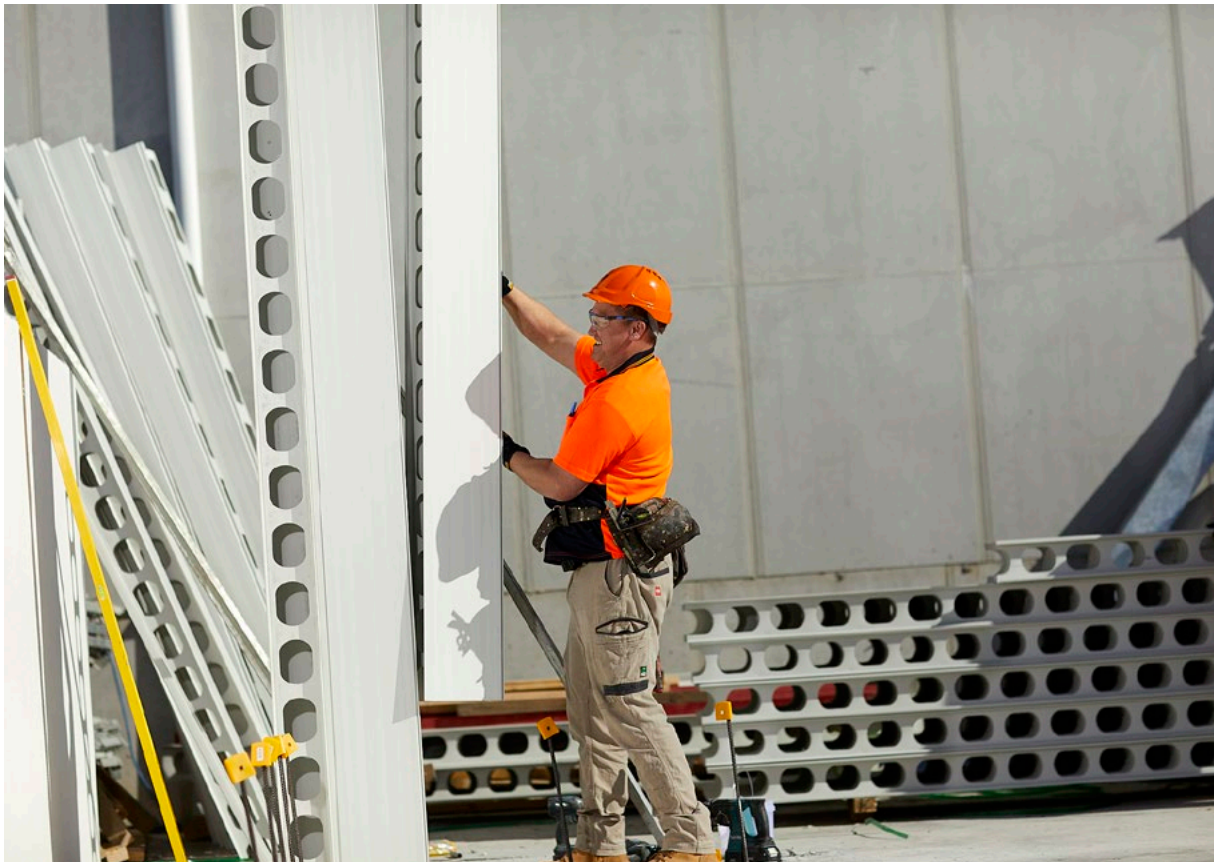

# SCC Construction Details

## Corners with Squint Angles

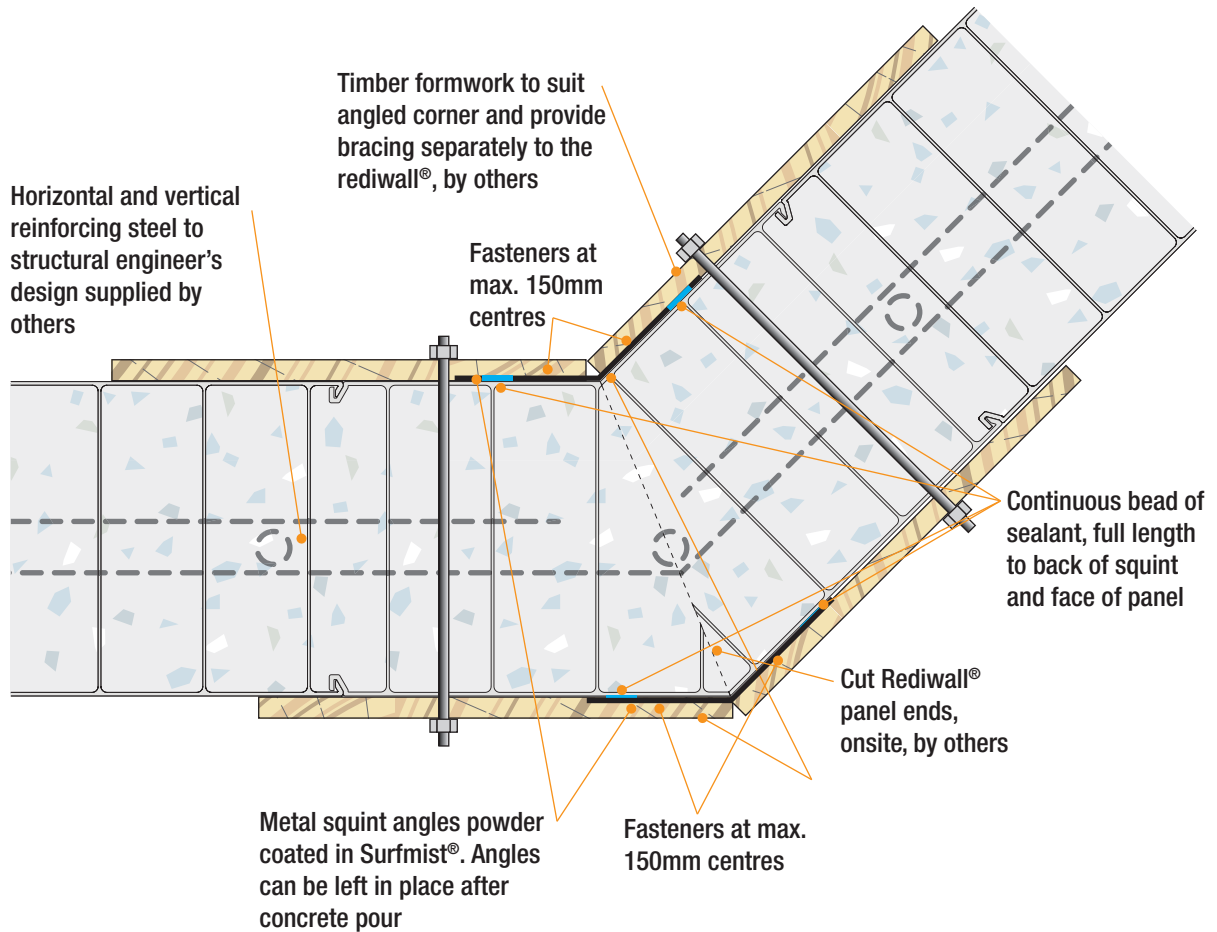

NOTE: Additional SCC formwork required for this detail. Consult site engineer.

Movement Joint – Vertical Junction

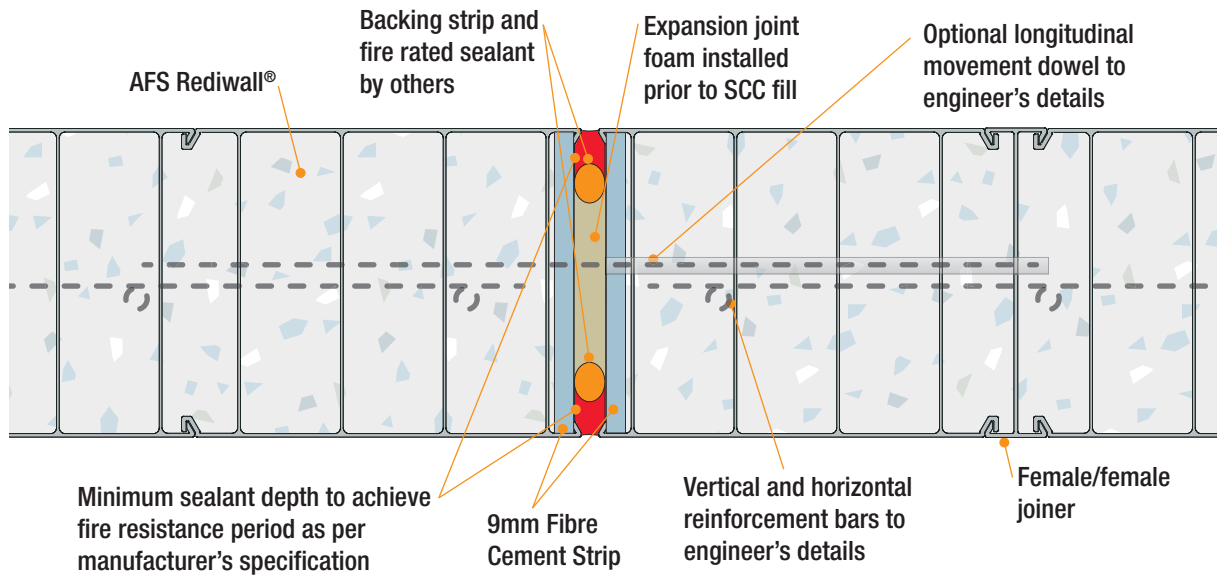

Notes:

- Can be dowel jointed if required structurally.
- Fire rating to be considered in project specifications.
- Refer to Volume 1 – Design, Performance & Compliance Guide, specific wall applications section to determine where this detail can be applied.

Movement Joint – Vertical Junction

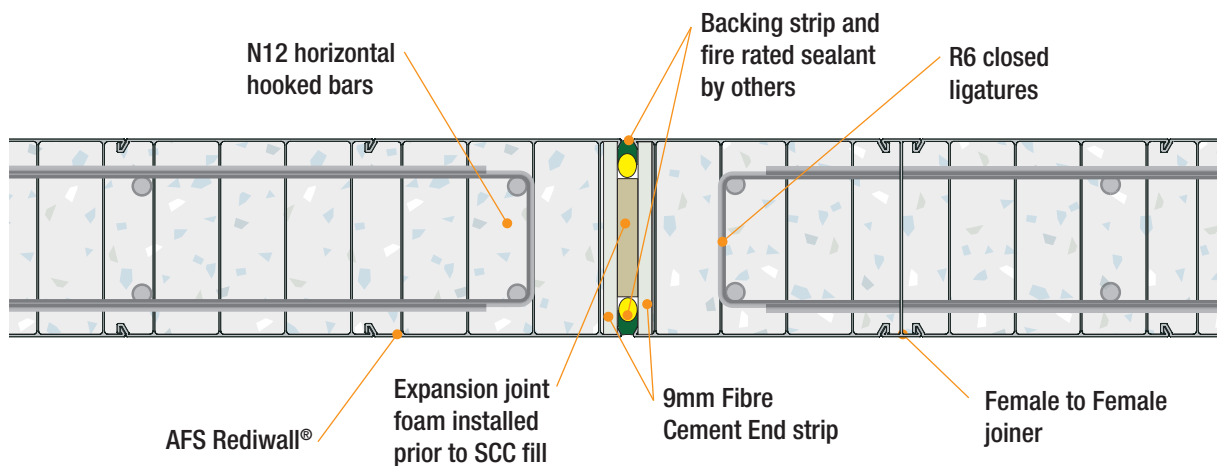

## Junction of Rediwall® Party Wall and External Fire Rated Wall

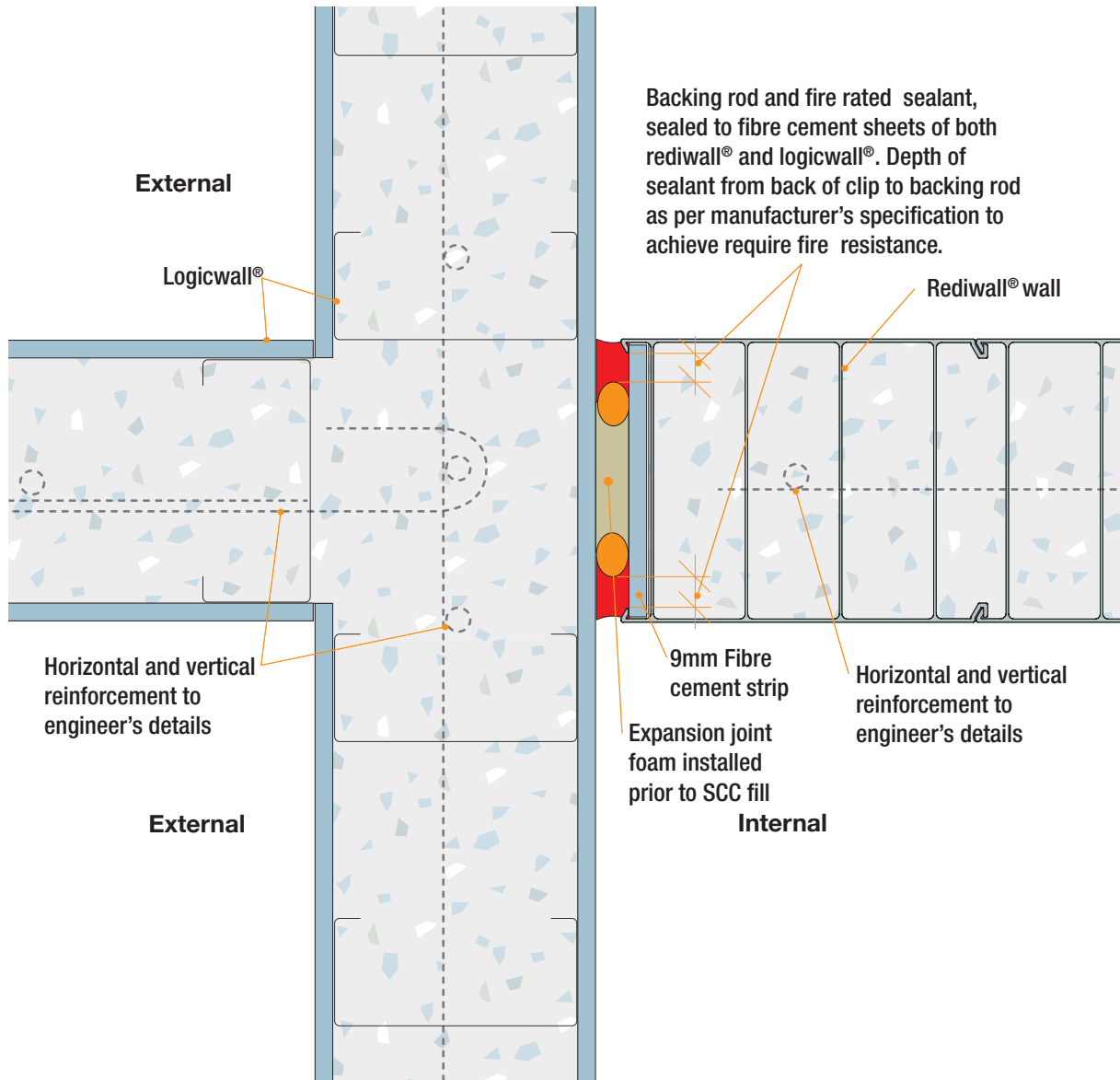

### NOTES:

Refer to Volume 1 – Design, Performance & Compliance Guide, specific wall applications section to determine where this detail can be applied.

Rediwall® Corner Junction

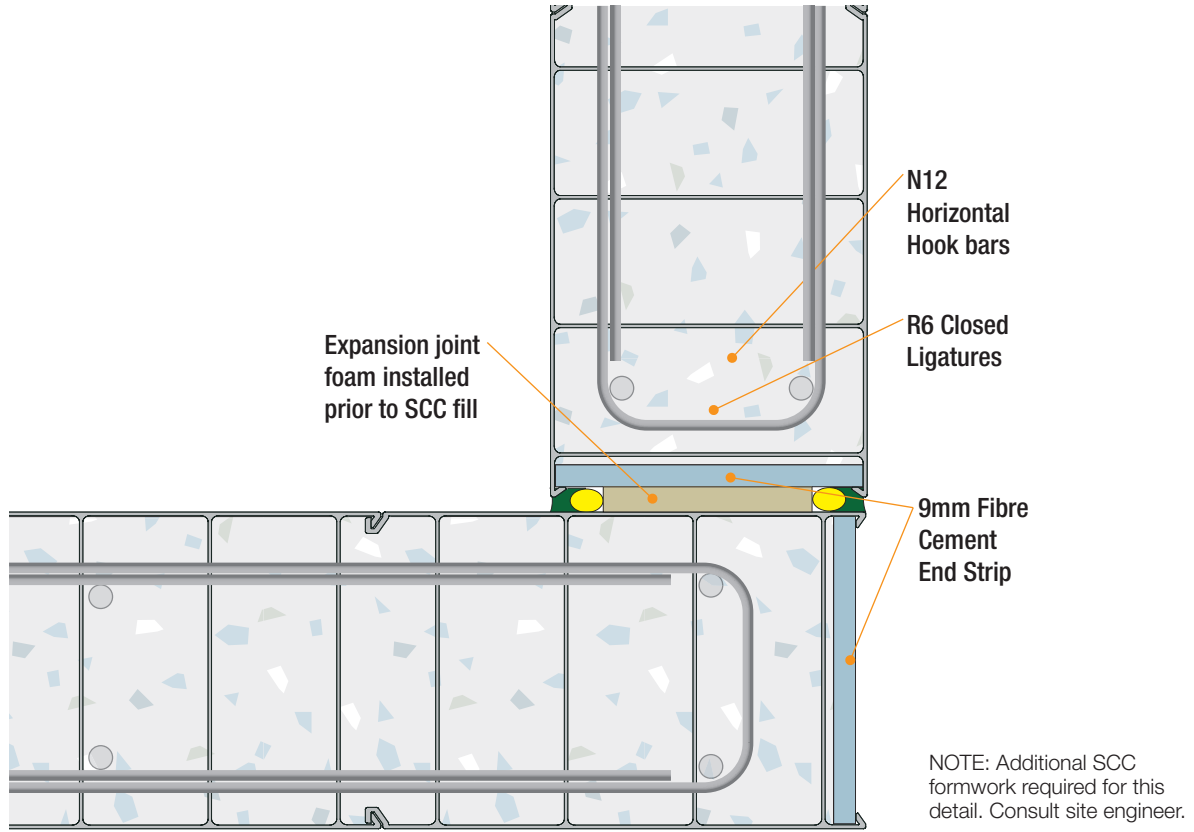

Rediwall® T-Junction with Movement joint

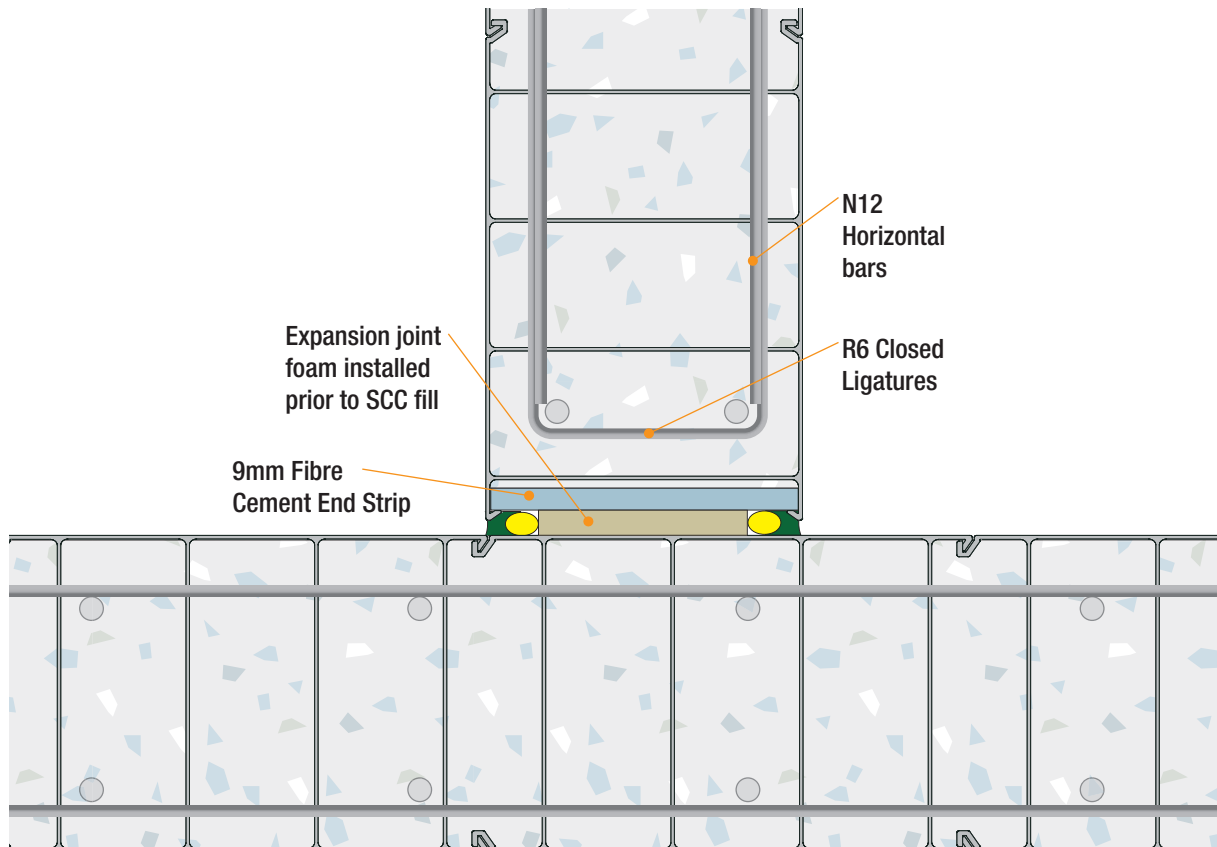



# Additional Bracing & Formwork Details for SCC

SCC typical edge brace

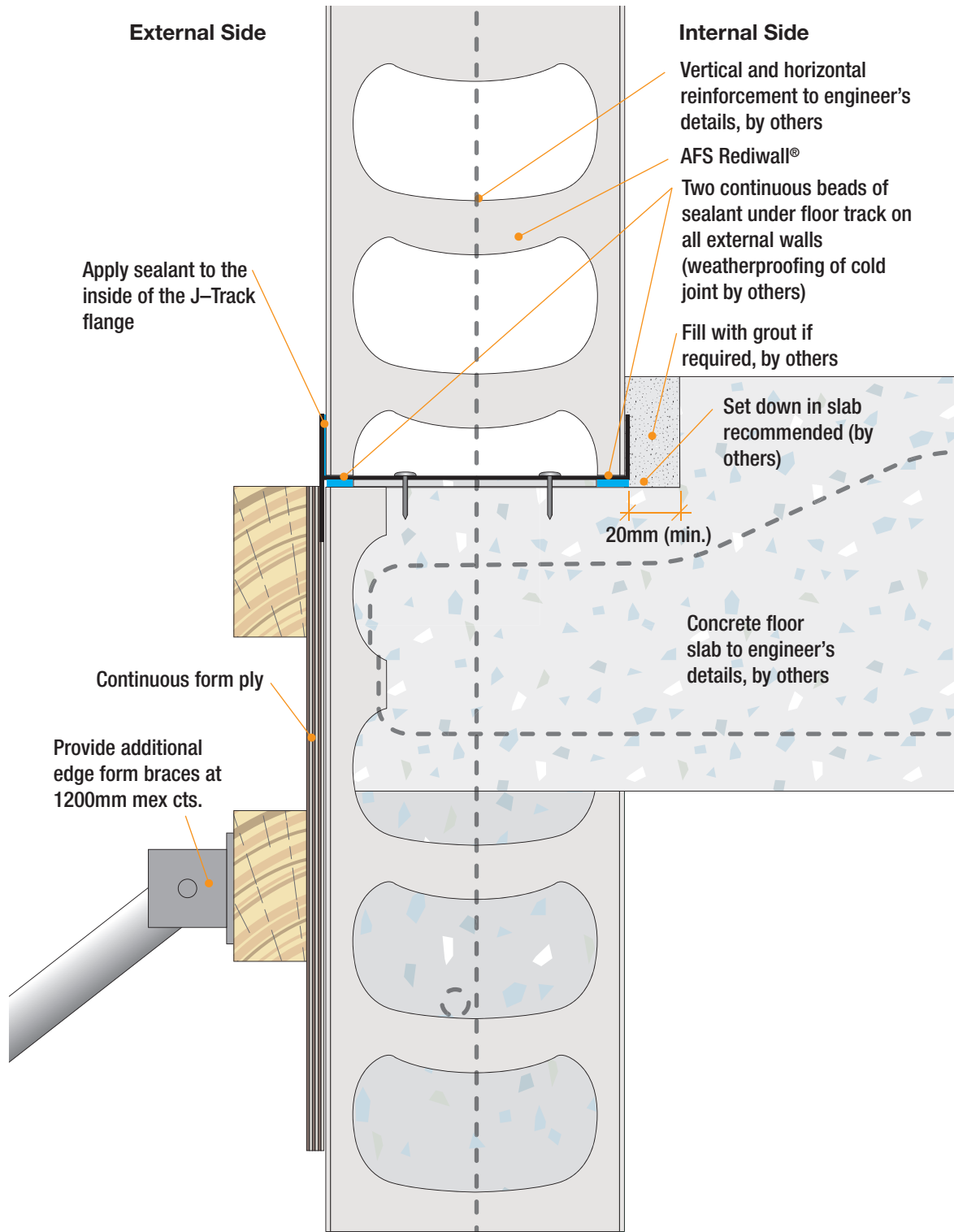

Typical Blade Column bracing detail

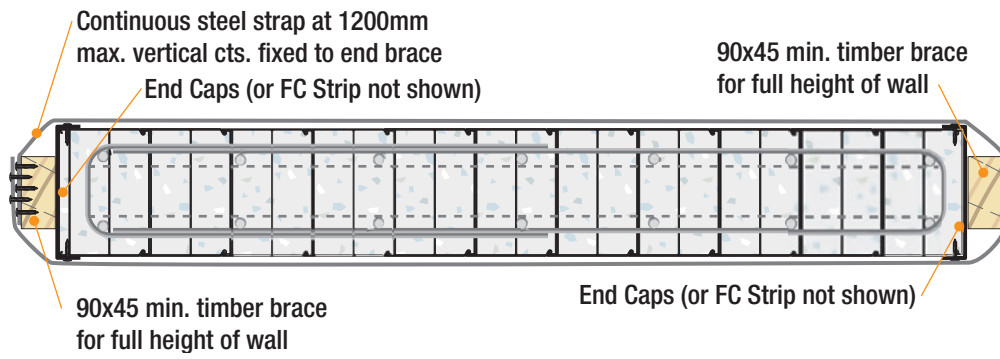

SCC window brace typical window opening

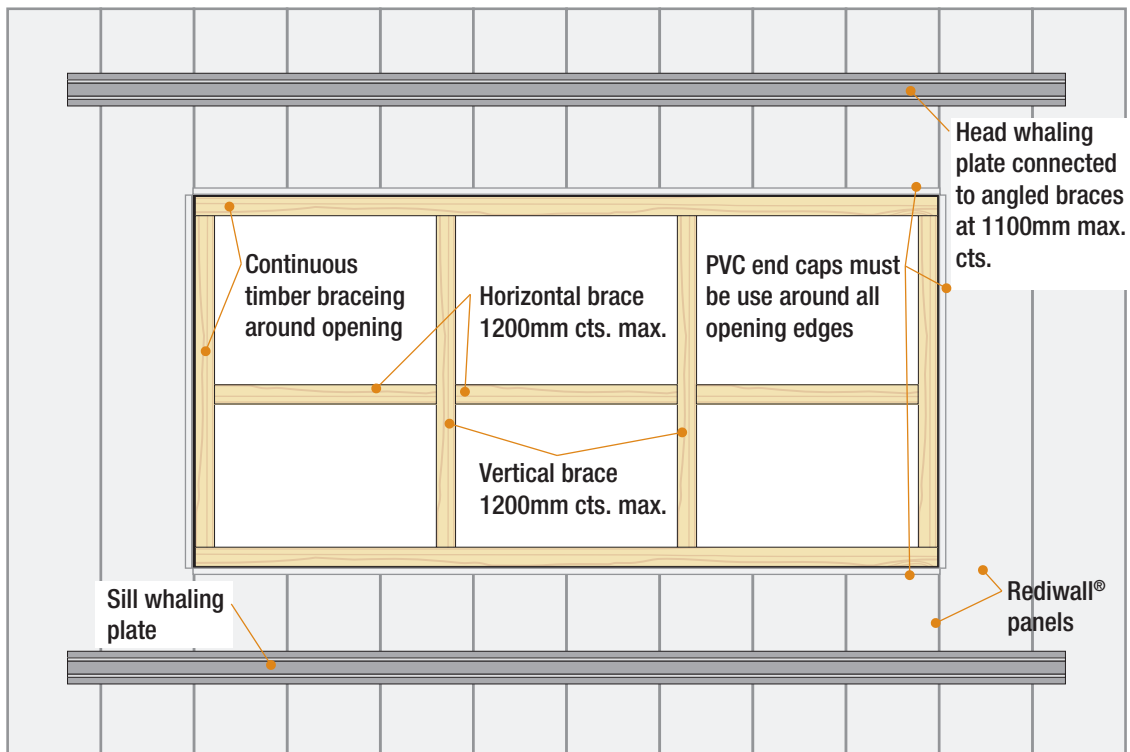

## SCC Bracing of T-Junctions

Where a T-junction is made, the main wall shall be adequately propped on the opposite side and local to the T-junction. This bracing is required to contain any lateral forces when this section of the wall is filled with concrete and to avoid dislodgement. For a short T-wall or nib, the end of this short T-wall shall also be adequately propped to stop potential bulging of T-junctions.

The external vertical bracing timber shall be the full height of the wall, and is to be pressed firmly against the wall opposite the T-junction. A backing plate of 19mm ply should be used with a width of a least 100mm overlap on either side of the panel junction width. For example RW200C requires an overall width of  $100+200+100=400\text{mm}$ . A minimum of 2 angled braces are to be used to support the bracing.

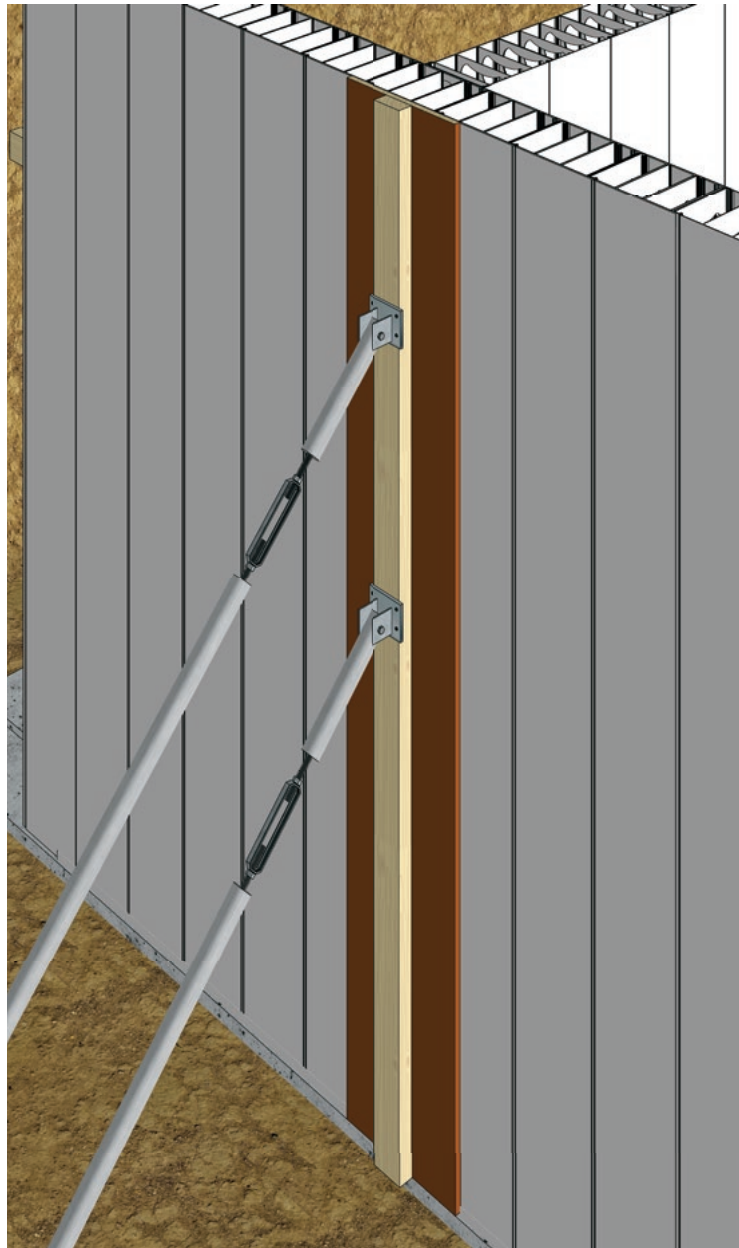



**Disclaimer:** The products referred to in this document have been manufactured by or on behalf of CSR Building Products Limited ("CSR") to comply with the Building Code of Australia and any relevant Australian Standards. While any design or usage guidelines set out in this document have been prepared in good faith by CSR, they are of a general nature only and are intended to be used in conjunction with project specific design and engineering advice. It is the responsibility of the customer to ensure that CSR's products are suitable for their chosen application, including in respect of project-specific matters such as, but not limited

structural adequacy, acoustic, fire resistance/combustibility, thermal, and weatherproofing requirements. All information relating to design/installation/application of these products is offered without warranty and no responsibility can be accepted by CSR for errors and omissions, or for any use of the relevant products not in accordance with CSR's technical literature or any other relevant industry standards. For current technical and warranty documentation relating to CSR's products, visit the AFS website at [www.afsformwork.com.au](http://www.afsformwork.com.au)

(C) 2024 AFS Systems Pty Ltd ABN 455 760 727 88  
BMS1929 1023 – November 24

**afs**

[afsformwork.com.au](http://afsformwork.com.au) • 1300 727 237

AFS Systems Pty Ltd • 110 Airds Road, Minto NSW 2566

**CSR**